TOSHIBA TOSVERT130 3-Series RS-485 Manual

**HIGH PERFORMANCE TRANSISTOR INVERTER
VECTOR DRIVE SERIES**

TOSHIBA



**TOSVERT-130
TRANSISTOR INVERTER**

RS485 COMMUNICATIONS OPTION MANUAL

TOSHIBA

Introduction

Thank you for purchasing the “RS485 option kit” for the Toshiba TOSVERT-130 G3 High-Performance Transistor Inverter. Before using the RS485 option, please be sure to thoroughly read the instructions and precautions contained in this manual. In addition, please make sure that this instruction manual is delivered to the end user of the inverter unit into which the RS485 option kit is installed, and keep this instruction manual in a safe place for future reference or inverter inspection.

This instruction manual describes the device specifications, wiring methods, maintenance procedures, protocol, functions and usage methods for the RS485 communications interface option.

TOSHIBA

Usage Precautions

Operating Environment

- Please use the option board only when the ambient temperature of the inverter unit into which the option board is installed is within the following specified temperature limits:

Operation: -10 ~ +40°C (+14 ~ +104°F)

Storage: -25 ~ +65°C (-13 ~ +149°F)

- Avoid installation locations that may be subjected to large shocks or vibrations.
- Avoid installation locations that may be subjected to rapid changes in temperature or humidity.

Installation • Wiring

- Do not touch charged parts such as the terminal block while the inverter's CHARGE lamp is lit. A charge will still be present in the inverter unit's internal electrolytic capacitors, and therefore touching these areas may result in an electrical shock. Always turn all inverter input power supplies OFF, and wait at least 5 minutes after the CHARGE lamp has gone out before wiring the communication cables or motor wiring.
- When installing the option board into the inverter and making wiring connections, make certain that no clippings or wiring leads that could cause device failure fall into the inverter or onto electronic components.
- Proper ground connections are vital for both safety and signal reliability reasons. For proper grounding procedures, please refer to the section in this manual pertaining to grounding (section 2.1).
- Route the communication cables separate from the inverter input/output power wiring.
- To avoid the possibility of electric shock due to leakage currents, always ground the inverter unit's E/GND terminal and the motor. To avoid misoperation, do not connect the RS485 option board's SHLD terminal to either of the above-mentioned grounds or any other power ground.

Other Precautions

- The inverter's EEPROM has a life span of 10,000 write cycles. Do not write to the same EEPROM address (bank 1) more than 10,000 times.
- When using broadcast communications, be sure to allow a time interval between broadcasts longer than that specified in section 7.4 Communications Interval.
- Do not touch or insert a rod or any other item into the inverter while power is applied, as this may lead to electrical shock or inverter damage.
- Always supply power first to the slave units and then to the master.
- Commission the disposal of the option board to a specialist.
- Do not assign the same inverter number to more than one inverter in the same system.
- Do not assign more than one inverter in the same system to be the master.
- When the inverter's control power supply is turned on, the inverter performs initialization functions for approximately 1 second, during which communications capabilities are disabled. Communications capabilities will also be disabled for approximately 1 second after momentary control power supply outages or inverter resets.

Table Of Contents

1. Option Board Installation / Removal	5
1.1 Installation	5
1.2 Removal	8
2. Connections	10
2.1 Grounding	10
2.2 Communications Cable Wiring	10
3. Equipment Specification	13
4. Maintenance And Inspection.....	13
5. Storage And Warranty	14
5.1 Storage	14
5.2 Warranty	14
6. RS485 Communications Function Overview	15
6.1 Computer Link Overview	15
6.2 Peer-To-Peer Communications Overview	16
7. Computer Link	17
7.1 Computer Link Parameter Settings	17
7.2 Computer Link Processing Flow.....	18
7.3 Sequence Explanation	19
7.4 Communications Intervals.....	20
7.5 Communications Format.....	21
7.5.1 <i>Data Transmissions From Host Computer To Inverter</i>	21
7.5.2 <i>Data Responses From Inverter To Host Computer</i>	22
7.6 Transmission Commands	24
7.6.1 <i>Command Summaries</i>	25
7.7 Communication Examples	29
7.7.1 <i>Communications Preparation</i>	29
7.7.2 <i>Timer Function</i>	30
7.7.3 <i>Examples</i>	31
7.7.4 <i>Address Increment Function Examples</i>	33
7.8 Example Host Computer Communication Programs	34
8. Peer-To-Peer Communication.....	41
8.1 Peer-To-Peer Communication Parameter Settings	41
8.2 Peer-To-Peer Communication Processing Flow.....	42
8.3 Sequence Explanation	42
8.4 Response Times.....	43

TOSHIBA





8.5 Transmission Format	45
8.6 Proportional Control	47
8.7 Peer-To-Peer Communication Timer Function	49
9. Appendix	50
9.1 Communications Specification	50
9.2 Communication Errors	52
9.3 Memory Configuration.....	55
9.4 Communications Data Tables	57
9.5 ASCII Character Codes	87
9.6 Notes	88

TOSHIBA

1. Option Board Installation / Removal

1.1 Installation

Installation of the TOSHIBA RS485 option board into a TOSVERT-130 G3 inverter should only be performed by a qualified technician familiar with the maintenance and operation of the G3. To install the option board, complete the following steps:

1.  **CAUTION!** Verify that all input power sources to the inverter have been turned OFF and are locked and tagged out.
2.  **DANGER!**  Wait at least 5 minutes for the inverter's electrolytic capacitors to discharge before proceeding to step 3. **Do not touch any internal parts with power applied to the inverter, or for at least 5 minutes after power to the inverter has been removed. A hazard exists temporarily for electrical shock even if the source power has been removed.**
3.  Remove the inverter's cover (open the door on units with hinged doors). Verify that the CHARGE LED has gone out before continuing the installation process.
4. Loosen the 4 screws attaching the G3's operation panel support bracket to the control board support bracket and remove the operation panel and support bracket as a unit (refer to Figure 1).

TOSHIBA

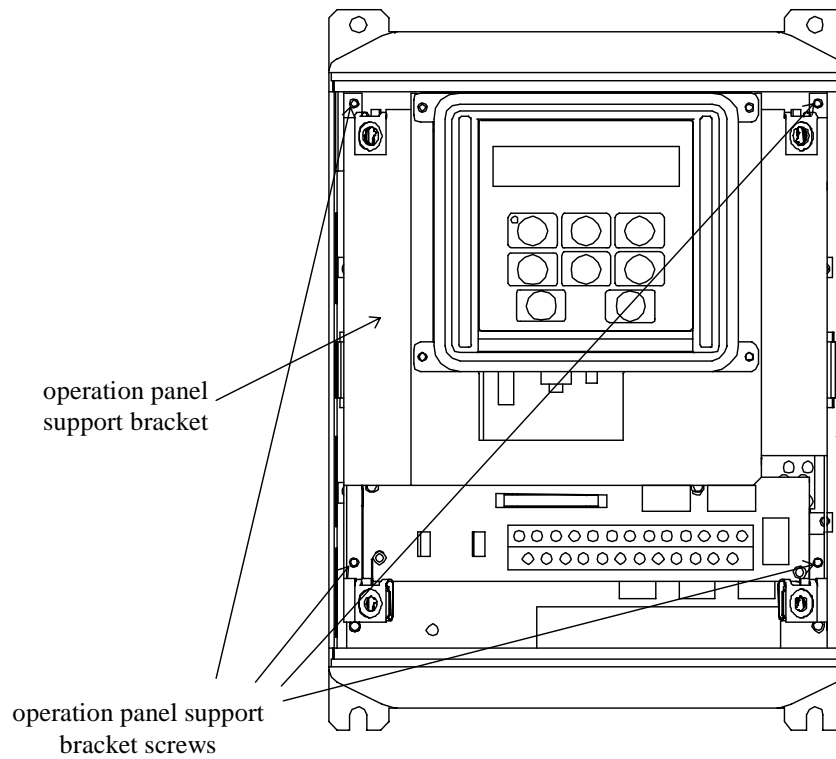

Figure 1: *G3 with front cover removed*

TOSHIBA

5. Install the 4 plastic option board standoffs into the holes provided in the control board support bracket (refer to Figure 2).

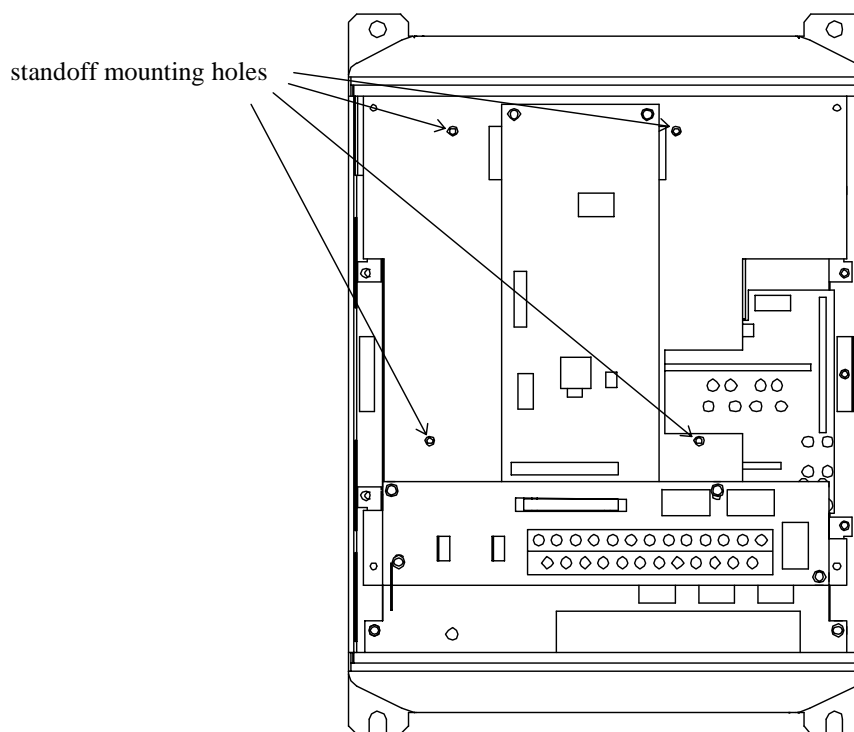



Figure 2: *G3 with front cover and operation panel support bracket removed*

6.  **CAUTION!** The RS485 option board is a static-sensitive device. Standard electrostatic-sensitive component handling precautions should be observed. Install the RS485 cable through the access holes at the bottom of the inverter and route the cable in order to make connections to the option board connector (TB1). Take care to not route the cable near any sharp edges or in positions where it may be pinched.
7. Connect the RS485 cable to the option board connector (TB1) according to the terminal markings (refer to section 2, Connections).
8. Install the option board into the inverter by carefully aligning the 4 plastic supports with the 4 mounting holes provided in the option board. Ensure that connector CN5A on the back side of the option board is aligned with connector CN5 on the front side of the control board.
9. Press the option board firmly onto the standoffs and connector CN5 until the standoff retaining tabs lock.
10. Carefully re-install the operation panel and support bracket and tighten the 4 screws that attach the operation panel support bracket to the control board support bracket.
11. Reinstall the inverter's cover (close and latch the door on units with hinged doors).



DANGER!



Do not operate the unit with the cover off / cabinet door open.

TOSHIBA

- Turn all power sources to the inverter unit ON, and verify that the inverter functions properly. If the inverter unit does not appear to power up, or does not function properly, immediately turn power OFF. **Repeat steps 1 ~ 3 to remove all power from the inverter.** Then, verify all connections. Contact Toshiba International Corporation for assistance if the problem persists.

1.2 Removal

Removal of the TOSHIBA RS485 option board from a TOSVERT-130 G3 inverter should only be performed by a qualified technician familiar with the maintenance and operation of the G3. In order to protect the option board connector's reliability, do not repeatedly connect and disconnect the option board. Use the following procedure if it becomes necessary to remove the RS485 option board from the inverter.



CAUTION! Do not remove the option board while power is applied to the inverter. Removing the option board with power applied may damage the inverter.

- CAUTION!** Verify that all input power sources to the inverter have been turned OFF and are locked and tagged out.
- DANGER!**

 Wait at least 5 minutes for the inverter's electrolytic capacitors to discharge before proceeding to step 3. **Do not touch any internal parts with power applied to the inverter, or for at least 5 minutes after power to the inverter has been removed. A hazard exists temporarily for electrical shock even if the source power has been removed.**
- Remove the inverter's cover (open the door on units with hinged doors). Verify that the CHARGE LED has gone out before continuing the removal process.
- Loosen the 4 screws attaching the G3's operation panel support bracket to the control board support bracket and remove the operation panel and support bracket as a unit (refer to Figure 3).
- CAUTION!** The RS485 option board is a static-sensitive device. Standard electrostatic-sensitive component handling precautions should be observed. Release the 4 corners of the option board from the standoffs by pressing down on the standoff locking tabs with a small flat-headed screwdriver. Be careful to not apply any abnormal stress to the option board while performing this, as this may damage the option board or control board connectors.
- Remove the option board from the inverter.
- Disconnect the communications cable from the option board connector (TB1), and pull the cable out through the access holes at the bottom of the inverter.
- Carefully re-install the operation panel and support bracket and tighten the 4 screws that attach the operation panel support bracket to the control board support bracket.

TOSHIBA

Figure 3: G3 with front cover removed

9. Reinstall the inverter's cover (close and latch the door on units with hinged doors).

**DANGER!**

Do not operate the unit with the cover off / cabinet door open.

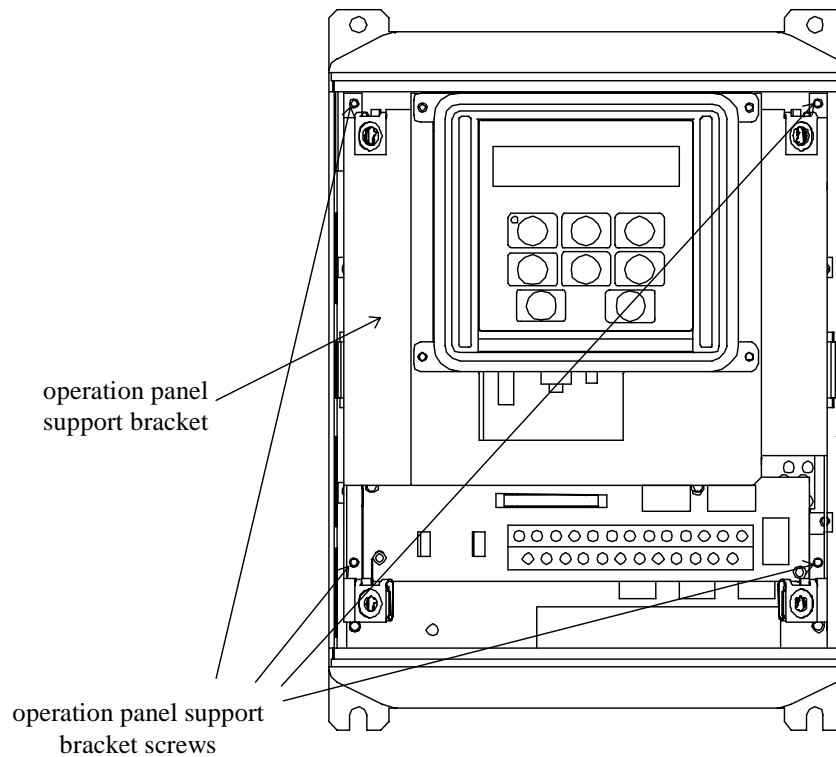
10. Turn all power sources to the inverter unit ON, and verify that the inverter functions properly. If the inverter unit does not appear to power up, or does not function properly, immediately turn power OFF. **Repeat steps 1 ~ 3 to remove all power from the inverter.** Then, verify all connections. Contact Toshiba International Corporation for assistance if the problem persists.

TOSHIBA

2. Connections

2.1 Grounding

Grounding is of particular importance for reliable, stable operation. Communication system characteristics may vary from system to system, depending on the system environment and grounding method used. A ground connection with an impedance of less than 100Ω should be used. Please be sure to consider the following points for making proper ground connections:

Grounding method checkpoints

- 1) Make all ground connections such that no ground current flows through the inverter case.
- 2) Ensure that all grounds are connected to points that are at the same potential as inverter grounds.
- 3) Do not connect the RS485 board SHLD terminal to a power ground or any other noise-producing ground connection (such as the inverter's E/GND terminal).
- 4) Do not make connections to unstable grounds (paint-coated screw heads, grounds that are subjected to inductive noise, etc.)
- 5) Use copper wire with a cross-sectional area of 2mm^2 or larger, or aluminum wire with a cross-sectional area of 2.6mm^2 or larger for grounding.

2.2 Communications Cable Wiring

Wiring

By using twisted-pair cable connected as shown in Figure 4, a complete communications system can be created. Connect each A to A, B to B, and SG to SG terminals throughout the system. Use twisted-pair cable that has a twisted A and B pair and a separate SG wire. If a peer-to-peer communication system is going to be used, substitute a G3 inverter (with jumper J3 set to the "TERM" position) in place of the host computer. If the host computer to be used is a standard personal computer with an RS232C serial port, the connection configuration of Figure 4 can be achieved by using an RS232C-to-RS485 converter.

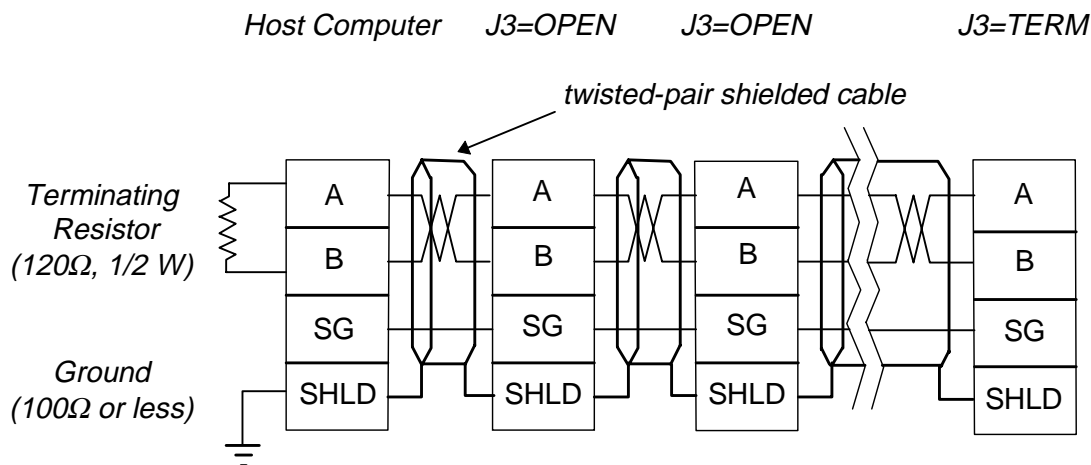
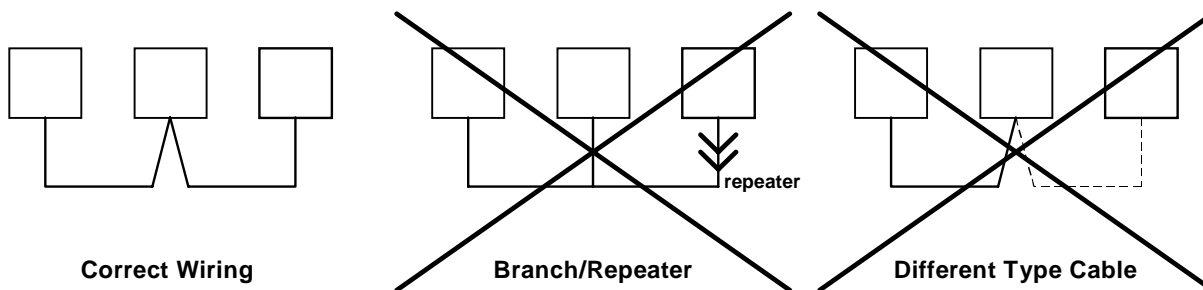

Figure 4. RS485 Communications Cable Connection

- Do not make any branch or star connections, etc., when connecting the signal wires. Always connect each unit in a successive series fashion, as shown in the figure above. For impedance-matching, always install a terminating resistor at the host computer-end of the system, and set jumper J3 on the RS485 option board in the inverter at the opposite end of the system from the host computer to the “TERM” position. Jumper J3 on all other RS485 option boards must be set to the “OPEN” position.
- The shield of the twisted-pair cable can either be connected to the SHLD terminal on each option board (as shown above), or only to the ground connection. In either case, please remember to keep these connections adequately isolated from any power or noise-producing grounds.

Notice

- **When wiring the communications cable, do not make any branch or repeater connections, or use a mixture of different types of cable, as shown below:**



- **Always keep the communications cable separated from inverter power wiring.**

Termination

The RS485 option board conforms to all EIA RS485 standards. To ensure signal integrity, always properly terminate the communication signal wires (A & B) at the extreme ends of the system. If a G3 inverter is located at a system endpoint, set jumper J3 on the RS485 option board installed in that inverter to the “TERM” position. If a different RS485 device is located at a system endpoint, ensure that a 120Ω, 1/2 W resistor is installed between the A and B terminals on that device. Inverters that are not located at endpoints of the system must have RS485 option board jumper J3 set to the “OPEN” position to achieve proper system operation.

TOSHIBA

Communications Cable Shield

Connect the shield of the twisted-pair cable either to the SHLD terminal on each option board in the system or to the ground connection only. Use a ground wire with a cross-sectional area of 2mm² or larger (refer to Figure 4).

Notice

Do not connect the shield wire to the inverter's E/GND terminal, or any other power or noise-producing ground.

Communication System Connection Specifications

Item	Specification
Configuration	bus type (terminating resistor selection on option card)
Cable	twisted-pair shielded cable
Cable Length	total 1000m maximum
Connection Points	32 maximum (including host computer in computer-link networks)
Connection Method	A, B, SG successive series connection. Connect to A and B with twisted-pair cable as shown in Figure 4. Note) Ensure that the signal lines (A & B) are properly terminated at the system endpoints.

Terminal Block Configuration (TB1)

Signal	Name	Function
A	Tx/Rx data	positive line
B	Tx/Rx data	negative line
SG	signal ground	signal line ground
SHLD	shield	protective shield connection for noise immunity

Note) Make all A/B/SG connections using twisted-pair cable AWG size 28 or larger.

TOSHIBA

3. Equipment Specification

Item	Specification
Operating Environment	Indoors, less than 1000m above sea level, do not expose to direct sunlight or corrosive / explosive gasses.
Operating Temperature	-10 ~ +40°C (+14 ~ +104°F)
Storage Temperature	-25°C ~ +65°C (-13 ~ +149°F)
Relative Humidity	20% ~ 90% (without condensation)
Vibration	5.9m/s ² {0.6G} or less (10 ~ 55Hz)
Grounding	Use a ground connection with an impedance of less than 100Ω.
Cooling Method	Self-cooled

4. Maintenance And Inspection

Preventive maintenance and inspection is required to maintain the RS485 option in its optimal condition, and to ensure a long operational lifetime. Depending on usage and operating conditions, perform a periodic inspection once every three to six months. Before starting inspections, always turn off all power supplies to the inverter unit, and wait at least five minutes after the inverter's "CHARGE" lamp has gone out.



DANGER!



Do not touch any internal parts with power applied to the inverter, or for at least 5 minutes after power to the inverter has been removed. A hazard exists temporarily for electrical shock even if the source power has been removed.

Inspection Points

- Check that the wiring terminal screws are not loose. Tighten if necessary.
- Check that there are no defects in any wire terminal crimp points. Visually check that the crimp points are not scarred by overheating.
- Visually check the wiring and cables for damage.
- Clean off any accumulated dust and dirt. Place special emphasis on cleaning the ventilation ports of the inverter and all installed PCBs. Always keep these areas clean, as adherence of dust and dirt can cause premature component failure.
- If use of the inverter unit is discontinued for extended periods of time, turn the power on at least once every two years and confirm that the unit still functions properly.
- Do not perform hi-pot tests on the inverter or RS485 option card, as they may damage the unit's internal components.

Please pay close attention to all periodic inspection points and maintain a good operating environment.

5. Storage And Warranty

5.1 Storage

Observe the following points when the RS485 option board is not used immediately after purchase or when it is not used for an extended period of time.

- Avoid storing the option board in places that are hot or humid, or that contain large quantities of dust or metallic dust. Store the option board in a well-ventilated location.
- When not using the RS485 option board for an extended period of time, turn the power on at least once every two years and confirm that it still functions properly.

5.2 Warranty

The RS485 option kit is covered under warranty for a period of 12 months from the date of installation, but not to exceed 18 months from the date of shipment from the factory. For further warranty or service information, please contact Toshiba International Corporation.

Please perform adequate maintenance and inspection procedures.

6. RS485 Communications Function Overview

6.1 Computer Link Overview

By using RS485 option boards, a network can be constructed that allows communication between a host computer and multiple inverter units. The computer link functions listed below allow for data transfers between the host computer and the inverter units connected to the system. By using these functions, the host computer can perform inverter operation control, data setting, and status monitoring. A computer program can be written that controls communication from the computer to an inverter, processing and analysis of the inverter's response, and formatted display of the response data. In the same way, the computer link functions allow a complete set of inverter parameter data to be read and saved on a floppy disk, and then edited or uploaded to other inverter units.

When performing computer link communication, both individual communication and broadcast communication are possible by selecting whether or not an inverter number is used:

- Individual communication from the host computer to a single inverter (inverter number used)
- Broadcast communication from the host computer to all inverters connected to the system (inverter number not used)

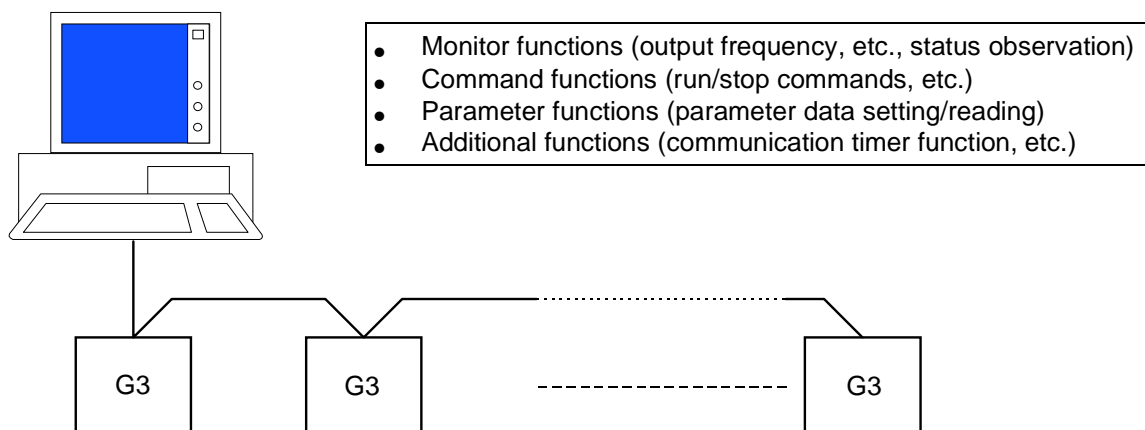

- Monitor functions (inverter status observation {output frequency, current, voltage etc.})
 - ✱ read from RAM (word/bit *¹)
 - ✱ read from EEPROM (word/bit *¹)
 - ✱ read from internal ROM (word/bit *¹)
 - ✱ read from external ROM (word/bit *¹)
- Command functions {inverter RUN/STOP etc., commands}
 - ✱ write to RAM (word/bit *¹)

TOSHIBA

- Parameter functions (parameter setting and reading)
 - ✱ read from/write to RAM (word/bit *¹)
 - ✱ read from/write to EEPROM (word/bit *¹)
 - ✱ simultaneously write to both EEPROM and RAM *² (word/bit *¹)
- Additional functions
 - ✱ communication timer function can detect broken cables, etc.
 - ✱ address increment function can automatically increment the address after reads/writes.

Notes

- *¹: Individual bit read/write can be performed by setting the data mask. When the data mask is used, bits that are masked off are read as "0", and are not changed when written to (refer to the mask setting command in section 7.6.1).
- *²: When writing to EEPROM addresses 03C0H ~ 04FEH (excluding 04D8H ~ 04F7H), both the EEPROM and RAM are written. When writing to all other addresses, only the EEPROM is written.
- ★ Throughout this document, the term "bit" will refer to the smallest computer data element, and will be represented as either a "0" or "1". Similarly, 8 bits will be referred to as a byte, and 16 bits (2 bytes) will be called a word.

6.2 Peer-To-Peer Communications Overview

By using RS485 option boards, a network can be constructed that allows communication between multiple inverter units (a host computer is unnecessary), in which frequency data is transferred between inverters in order to produce proportional operation. The frequency data is transmitted from the master (1 unit per system) to the slaves (1 ~ 31 units per system), which then operate at frequencies proportional to the master (for more information pertaining to proportional operation, refer to section 8.6).

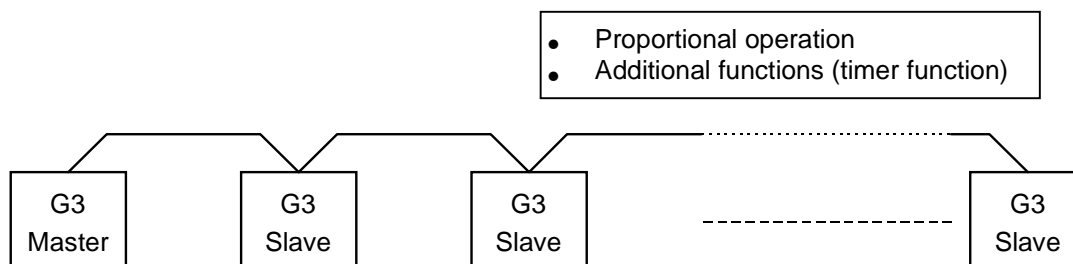

- Proportional operation
Frequency data is transmitted from the inverter selected to be the master to those selected to be the slaves. The slaves then operate according to the data received from the master.
- Additional functions
The communications timer function can detect broken cables, etc.

7. Computer Link

7.1 Computer Link Parameter Settings

Before using computer link communications, the following parameters must be set:

[1] Unblind the communication parameters:

- Set BLIND FUNCTION SELECTION in GROUP:UTILITY PARAMETERS to 1.
- Set COMMUNICATION PARAMS BLIND in GROUP:UTILITY PARAMETERS to 1.

[2] With the communication selection parameter, select RS485:

- Set COMMUNICATION SELECTION in GROUP:COMMUNICATION SETTING PARAMETERS to 1.

[3] Select slave device:

- Set MASTER/SLAVE SELECTION in GROUP:COMMUNICATION SETTING PARAMETERS to 0.

[4] Select the baud rate, number of data bits, and parity:

- Baud rate: set by RS485 BAUD RATE in GROUP:COMMUNICATION SETTING PARAMETERS and option board jumpers J1 and J2 (refer to section 9.1 Communications Specification).
- Number of data bits: set by NUMBER OF DATA BITS in GROUP:COMMUNICATION SETTING PARAMETERS.
- Parity: set by PARITY SETTING in GROUP:COMMUNICATION SETTING PARAMETERS.

[5] Select inverter numbers (Note: Do not assign the same inverter number to more than one inverter per system):

- Select a number for each inverter with INVERTER ID NUMBER in GROUP:COMMUNICATION SETTING PARAMETERS.

[6] Set the frequency mode:

- To use the RS485 frequency command value, set FREQUENCY MODE SELECTION in GROUP:UTILITY PARAMETERS to 3.
- To use a terminal input frequency command value, set FREQUENCY MODE SELECTION in GROUP:UTILITY PARAMETERS to 1.
- To use the panel input frequency command value, set FREQUENCY MODE SELECTION in GROUP:UTILITY PARAMETERS to 2.

[7] Set the command mode:

- To control RUN/STOP, etc., via RS485, set COMMAND MODE SELECTION in GROUP:UTILITY PARAMETERS to 3.
- To control RUN/STOP, etc., via terminal input, set COMMAND MODE SELECTION in GROUP:UTILITY PARAMETERS to 1.
- To control RUN/STOP, etc., via panel input, set COMMAND MODE SELECTION in GROUP:UTILITY PARAMETERS to 2.

TOSHIBA

7.2 Computer Link Processing Flow

In computer link communications, the inverters are always in a state of waiting for commands from the host computer. From the time data is received until the data processing is over, however, additional data cannot be received. When data is transmitted from the host computer, all inverters connected to the system check to see if an inverter number has been included in the transmission, and if so, whether or not the transmitted number matches their own number.

If an inverter number was included and the number matches, the inverter decodes the command it has received, and then transmits a response back to the host computer. If an inverter number error, parity error, framing error, overrun error, or checksum error occurs, however, no response is transmitted (refer to section 9.2 Communication Errors for more information).

If an inverter number was included and the number does not match, the inverter discontinues processing, discards the data, and prepares for the next data reception.

If an inverter number was not included in the transmission from the host computer, the transmission is considered to be a broadcast message, and all inverters connected to the system process the data. After processing a broadcast message, the inverters prepare for the next data reception without transmitting a response back to the host computer.

Individual Communications

Ex: All inverters are operating at 60Hz. The host computer sends a 50Hz operating frequency command to inverter #3.

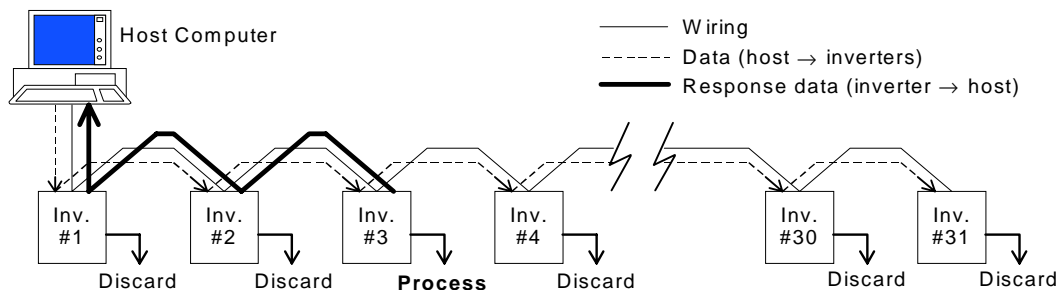

- (1) The host computer transmits the data.
- (2) All inverters receive the data and check for an inverter number.
- (3) Only the inverter whose number matches decodes the command and processes the data.
- (4) The inverter adds its inverter number to the processing result, and sends this as a response.
- (5) In this example, only Inv. #3 will begin operating at 50Hz. All others will continue operating at 60Hz.

Broadcast Communications

Ex: All inverters are operating at 60Hz. The host computer broadcasts a 50Hz frequency command to all inverters.

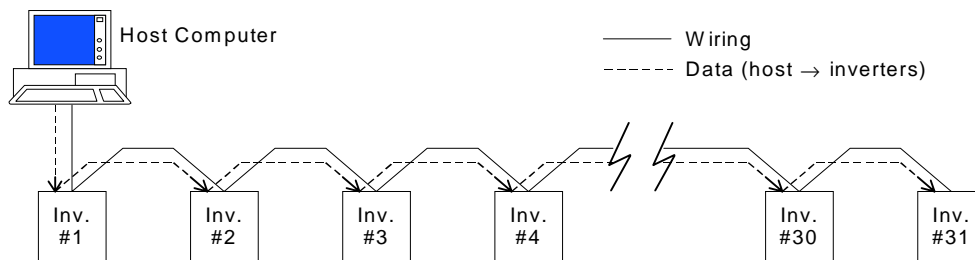

- (1) The host computer transmits the data.
- (2) All inverters receive the data and check for an inverter number.
- (3) Because an inverter number was not sent, all inverters decode the command and process the data.
- (4) So that bus contention does not occur, no responses are sent to the host computer.
- (5) In this example, all inverters will begin operating at 50Hz.

TOSHIBA

7.3 Sequence Explanation

(Host computer and inverter data exchanges)

- (1) The inverters wait for a request from the host computer to establish a computer link.
- (2) The inverters ignore all characters received before a “(“ character. If multiple “(“ characters are received, only the last one received is valid, and all others are discarded.

Ex: HOST COMPUTER → INVERTER INVERTER → HOST COMPUTER
 W%3R (00A03C0) (00A03C0)

- (3) When an inverter number is included after the “(“ character, only when that number corresponds to the inverter’s number will the transmission be valid. If the number does not correspond, the inverter will not send any response, and will wait for the next “(“ character.
- (4) When an inverter number is not included after the “(“ character, the transmission is regarded as a broadcast message, and all inverters connected to the system will accept the command. In order to avoid bus contention, no responses will be sent to the host computer.
- (5) Only when a carriage return code (0DH) is received will the transmission be considered terminated. If the transmitted message exceeds the maximum number of characters allowed (14), a communications error (error code 0001) is generated.
- (6) If an inverter’s communication timer is set, and if a transmission is not received within the set time, a communications error will be generated and the inverter will trip (LCD display will show “OPTION PCB ERROR (PRESS CLEAR)”). (Standard shipment setting for the communications timer is “OFF” (0), so if the timer is to be used, the timer time must be set. For more information on setting the communication timer, refer to section 7.7.2 Timer Function).
- (7) If the message does not correspond to the format described in section 7.5 Communications Format, a communications error will be generated. If an error occurs after the “(“ character is received, the communications alarm indicator “COMM” will flash on the LCD display until the next correct data message is received.
- (8) After the received command is processed, a response is sent back to the host computer. If an inverter number was not included in the original transmission, however, no response will be sent, as the transmission was a broadcast message.
- (9) During the time period from when the data has been received until the command processing is completed, subsequent transmissions cannot be received. When using broadcast communications, be sure to allow a time interval between broadcasts longer than that specified in section 7.4 Communications Interval.

In addition, when using individual communications (inverter number used), do not begin the next transmission until 2ms after a reply has been received from the inverter (4ms when simultaneously using RS232C communications). However, if no reply is received within about 300ms after the transmission has been sent (about 320ms when simultaneously using RS232C communications), a “no response” error has occurred (refer to section 9.2 Communication Errors). When this occurs, after the 300ms interval (or 320ms when simultaneously using RS232C communications), the next data transmission can be sent. For more information, refer to section 7.4 Communications Interval.

TOSHIBA

7.4 Communications Intervals

When transmitting data from the host computer to G3 inverters, please observe the following items regarding the communications time interval.

Broadcast communication time interval

When performing broadcast communications, always provide a time interval between transmissions as long or longer than the value shown in the table below. If the time between transmissions is shorter than the value shown, the latter transmission will not be received correctly by the inverter.

Ex: "W" command (without RS232C), 9600 baud, 7-bit length and even parity: the data transmissions (a), (b), and (c) are being sent at intervals shorter than the specified limit.

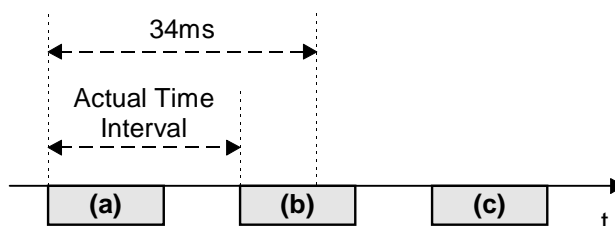

Data (a) and (c) will be received correctly, but data (b) will not be received correctly. In order for all transmissions to be received correctly, an interval of 34ms or more (found in the following table) must be allotted between transmissions.

Baud rate	7-Bit Data Length		8-Bit Data Length	
	No RS232C	RS232C	No RS232C	RS232C
1200 baud	122ms	143ms	142ms	153ms
2400 baud	72ms	93ms	77ms	98ms
4800 baud	47ms	68ms	49ms	70ms
9600 baud	34ms	55ms	36ms	57ms
19200 baud	28ms	49ms	29ms	50ms
38400 baud	25ms	46ms	25ms	46ms

Individual communications time interval

When using individual communications, the following time intervals must be observed after receiving a data response from an inverter before the next transmission can be sent:

- After a data response is sent from an inverter to the host computer, that inverter cannot receive subsequent transmissions from the host computer for a maximum of 2ms (4ms when simultaneously using RS232C communications).
- When an inverter receives a transmission with an inverter number different than its own, that inverter cannot receive subsequent transmissions from the host computer for a maximum of 4ms (8ms when simultaneously using RS232C communications).

Remember that when a time interval violation occurs, no response will be sent from the inverter.

Caution

Always allow a time interval of at least the minimum time given above.

TOSHIBA

7.5 Communications Format

All data is represented in hexadecimal format, and inverter status data is not included in the response data (except for the addition of the “#” character when the inverter is tripped). All transmitted characters conform to the 7-bit (or 8-bit) ASCII (ANSI) standards (refer to section 9.5 ASCII Character Codes).

- If monitoring the inverter status is desired, refer to the status monitor portion of section 9.4 Communications Data Tables.

7.5.1 Data Transmissions From Host Computer To Inverter

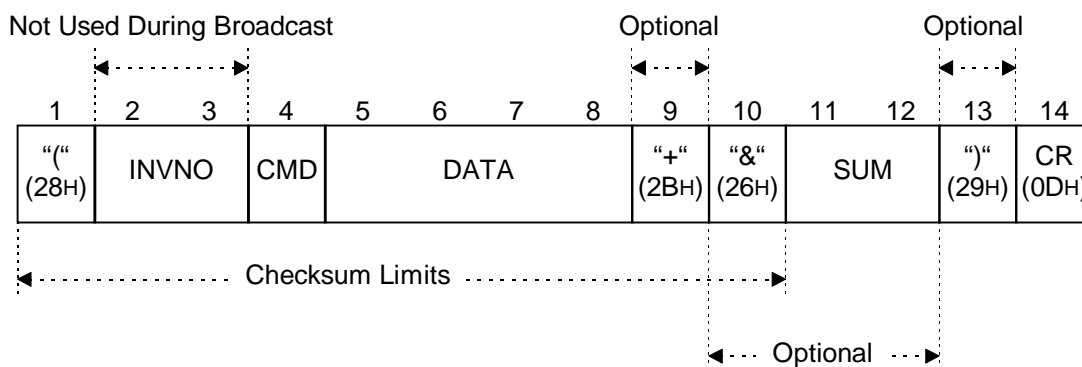

1. "(" (1 character) Header code
2. INVNO (2 characters) Inverter number (not used during broadcast communications): 00 (30H, 30H) ~ 99 (39H, 39H) [base 10]. Only when this number and the inverter number set via the inverter control panel match will the command be recognized. If this number does not match the inverter number, or if this number is only 1 character long, the command will not be recognized and no response will be sent. Please note that only a maximum of 31 inverter units can be connected to a system. Do not use an inverter number when performing broadcast communications. Also, during broadcast communications, no data responses will be sent.
Note: Because the panel setting is in base 10, the transmitted number must also be in base 10.
3. CMD (1 character) Command (refer to section 7.6.1 Command Summaries) [base 16].
4. DATA (0 ~ 4 characters) Data (refer to section 7.6.1 Command Summaries) [base 16].
5. "+" (1 character) Address increment code (optional). Only valid during R/W commands. After the R/W command is performed, the inverter's address data is automatically incremented by 1 word (address data + 2). (Because the address data is changed, the mask data returns to its initialization value of FFFFH).
 - If there is no "+" character or if an error occurs, the address and mask data remain unchanged.
6. "&" (1 character) Checksum indicator code (optional). Do not include checksum data when this character is not used.
7. SUM (2 characters) Checksum (optional). ASCII-coded, least-significant 2-digit value (4 bits/digit) of the sum total addition of the ASCII code values from the header code to the checksum indicator code. Do not include a checksum indicator code when the checksum data is not included.
8. ")" (1 character) Termination code (optional).
9. CR (1 character) Carriage return code.

TOSHIBA

7.5.2 Data Responses From Inverter To Host Computer

[Normal Condition]

When an inverter number is not included in a data transmission from the host computer (broadcast communication), or when the transmitted inverter number does not match an inverter's set number, the inverter does not transmit a response to the host computer.

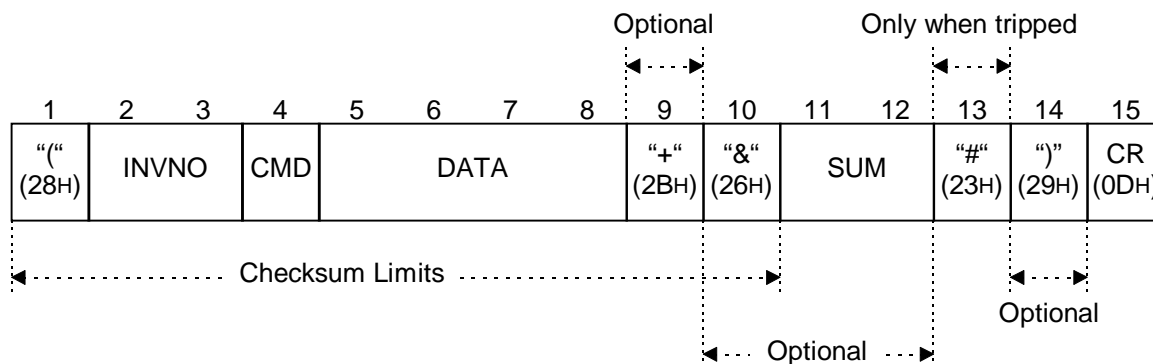

1. “ (1 character) Header code
2. INVNO (2 characters) Inverter number: 00 (30H, 30H) ~ 99 (39H, 39H) [base 10]. If the transmitted number does not match the inverter number, or if the transmitted number is only 1 character long, the command will not be recognized and no response will be sent (in addition, no response is sent when no inverter number was initially transmitted).
3. CMD (1 character) Command. The received command is returned.
4. DATA (4 characters) Data. Except for the “R” and “W” commands, the received data is returned (for the “R” command, the read data is returned, and for the “W” command, the data after writing is returned). If the received data was less than 4 characters in length, the returned data is extended to 4 characters (Ex: (00B0) → (00B0000)).
5. “+” (1 character) Address increment code. Returned only when initially received. (Only valid during R/W commands. After the R/W command is performed, the inverter's address data is automatically incremented by 1 word (address data + 2), and the mask data is returned to its initialization value of FFFFH).
6. “&” (1 character) Checksum indicator code. Returned only when initially received.
7. SUM (2 characters) Checksum. ASCII-coded, least-significant 2-digit value (4 bits/digit) of the sum total addition of the ASCII code values from the header code to the checksum indicator code (returned only when a checksum indicator code was initially received).
8. “#” (1 character) Inverter tripped code. Only returned when the inverter is tripped.
9. “)” (1 character) Termination code (returned only when initially received).
10. CR (1 character) Carriage return code.

<< Note >> When a reset command is received, the inverter may reset during the response process, resulting in an incomplete response.

TOSHIBA

[Error Condition]

When any of the errors described below occur while a command is being processed, the communications error code (N), the error number (refer to section 9.2 Communication Errors), and checksum data (if initially received), are returned to the host computer. No response will be sent to the host computer during broadcast communications, when the inverter number does not match, when a format error occurs, or when an inverter number was transmitted but a checksum error occurs, as this could cause bus contention (when an error occurs, the communications error alarm "COMM" will blink on and off on the LCD display until the next correct transmission is received).

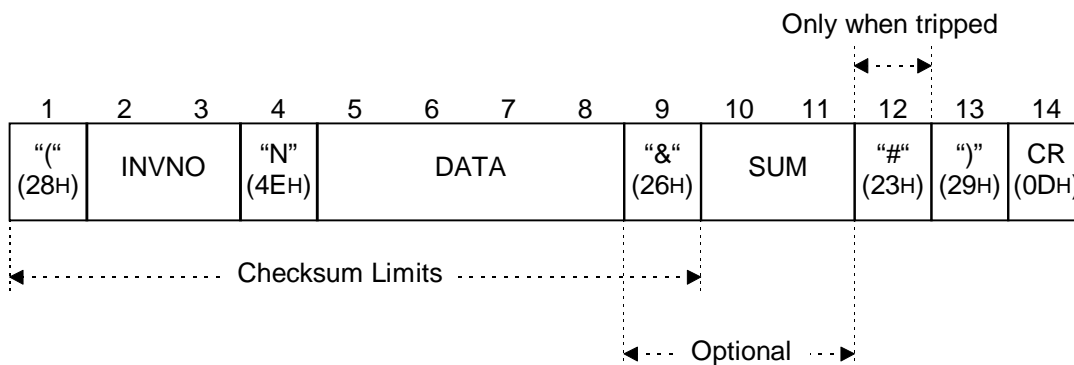

"(" (1 character) Error code.

DATA (4 characters) Data (0000 ~ 0003).

0000 ...cannot execute (communication was correct, but cannot execute command. Typical causes: attempt to write a parameter that cannot be written while the inverter is running (MAXIMUM OUTPUT FREQUENCY, VOLTS PER HERTZ PATTERN, etc.), EEPROM error).

0001 ...data error (data setting value outside of adjustment range, data exceeded 4 characters, etc.)

0002 ...address error (address data outside of adjustment range when a "W" command was sent, etc.)

0003 ...command error (invalid command).

)" (1 character) Termination code. Returned even when not initially received.

Examples (using inverter number "01"):

(01N0000&BD)cannot execute (attempt to change MAXIMUM OUTPUT FREQUENCY while the inverter was running, etc.)

(01N0001&BE)data error (attempt to set a preset speed higher than the UPPER LIMIT FREQUENCY setting, etc.)

(01N0002&BF)address outside limits (a "W" command was sent with the address data set to a write-protected area (RAM: address set to less than 3C0H or higher than 516H, EEPROM: less than 3C0H or higher than 59EH), etc.)

(01N0003&C0)command error (command other than A, B, M, R, W, or T sent, etc.)

no responseinverter number only 1 digit long, inverter number does not correspond to any inverter in the system, format error (parity error, overrun error, framing error), checksum error, etc.

7.6 Transmission Commands

- 1) **A** (41H): address setting command
 - 2) **R** (52H): read command (word read)
 - 3) **W** (57H): write command (word write)
 - 4) **M** (4DH): mask setting command
 - 5) **B** (42H): bank setting command
 - 6) **T** (54H): communications confirmation (test) command
- Once set, the address, bank, and mask setting data do not change until they are set to different values, except for the following conditions:
 - ⇒ whenever the address data is changed, the mask data returns to its initialization value of FFFFH.
 - ⇒ whenever the address increment function is used in conjunction with the “R” or “W” commands, the address data is automatically incremented by 1 word (2 bytes), and the mask data therefore returns to its initialization value of FFFFH .

Initial Values

When power is first applied to the inverter unit, or after a reset or trip clear, etc., the following data values are initialized:

Address data = 0508H..... (option (RS485) frequency command setting address)
 Bank data = 0000H..... (RAM)
 Mask data = FFFFH.... (all bits can be written to)

TOSHIBA

7.6.1 Command Summaries

[A] Address setting command

Sets the address to be used when reading or writing (refer to the “Address” columns of the communications data tables in section 9.4).

Address Settings (address data limits: 0000H ~ FFFFH)

Bank	R/W	Read	Write
Bank = 0 (RAM)	R/W	0100H ~ 077EH	03C0H ~ 0516H *1
Bank = 1 (EEPROM)	R/W	0000H ~ 7FFEh	03C0H ~ 059EH *1 *2
Bank = 2 (Internal ROM)	R	8000H ~ FFFEh	×
Bank = 3 (External ROM)	R	0000H ~ FFFEh	×
Bank = 4 (Option bus)	R	0000H ~ 1FFEh	×

- *1: The following RAM and EEPROM locations cannot be written to:
04D8H ~ 04F7H, 0500H ~ 0507H (RAM only), 04FAH bits 4 and 5, 04FBH bit 7, 050AH bits 4 and 5 (RAM only), 050BH bit 7 (RAM only), 0512H bits 4 and 5 (RAM only), 0513H bit 7 (RAM only).

Bit position example: (Address 04FAH)

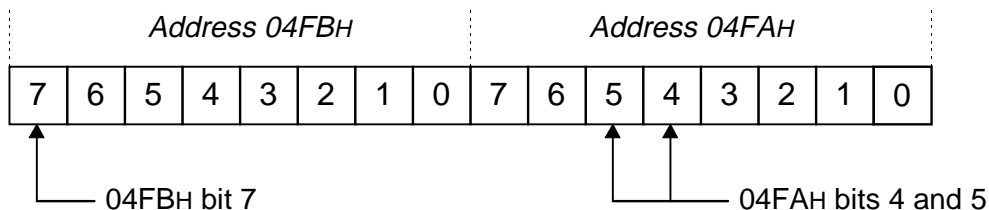

- *2: When addresses 03C0H ~ 04FEH (excluding 04D8H ~ 04F7H) are written to, both RAM and EEPROM contents are changed. Writing to all other addresses changes only the EEPROM contents.
- Once set, the address data does not change until it is set to a different value, except when the address increment function is used in conjunction with the “R” or “W” commands, in which case the address data is automatically post-incremented by 1 word (2 bytes). On power-up or after a reset, etc., the address data is initialized to 0508H (option frequency command).

Caution

The address data should only be set to a maximum of 1 byte less than the bank’s upper limit. For example, the read limits of RAM (bank 0) are from 0100H ~ 077FH, so if you would like to read from address 077FH, set the address to 077EH and then retrieve the data from the upper byte of the response word. If the address were set to 077FH and a read were performed, an attempt would be made to access address 0780H, which is above the maximum address limit.

TOSHIBA

[B] Bank setting command

Sets the type of memory to be accessed (refer to the “Bank” columns of the communications data tables in section 9.4).

Bank Settings (bank data limits: 0000H ~ 0004H):

- 0000RAM
 - 0001EEPROM
 - 0002Internal ROM (read-only)
 - 0003External ROM / Option ROM (read-only)
 - 0004Option bus (read-only)
- └── Optional (only the lowest digit is required)

- Once set, the bank data does not change until it is set to a different value. On power-up or after a reset, etc., the bank data is initialized to 0000H (RAM).

[M] Mask setting command

Allows the access of only the data required during read/write operations. During data writes, data checking is performed to ensure that the data is being set within adjustment limits, but only that portion of the data that is within the limits of the mask setting is checked (refer to the “Mask” columns of the communications data tables in section 9.4). Mask data limits = 0000H ~ FFFFH.

When writing data, set the mask bits to binary “1” for those bits that you would like to change, and set the mask bits to binary “0” for those bits that you do not want to change. When reading data, set the mask bits to binary “1” for those bits that you would like to read, and set the mask bits to binary “0” for those bits that you do not want to read. At read time, all data bits for which the corresponding mask bits are “0” will be read as “0”.

- Once set, the mask data does not change until it is set to a different value or until the address data changes. When the address data changes (including when the address-increment function is used in conjunction with the R/W commands), the mask data is automatically set to its initialization value of FFFFH, which allows all bits to be read/written. Upon inverter power-up or after a reset, etc., the mask data is initialized to FFFFH.

Ex: To set the command mode selection on inverter number 00 to “communication option input valid” (refer to COMMAND MODE SELECTION in GROUP:UTILITY PARAMETERS in section 9.4):

<u>HOST COMPUTER → INVERTER</u>	<u>INVERTER → HOST COMPUTER</u>
(00B1)	(00B0001) set bank to EEPROM
(00A4B7)	(00A04B7) command mode selection address
(00M7)	(00M0007) mask = (0000 0000 0000 0111) ₂
(00W3)	(00Wxxxx) data depends on other bits

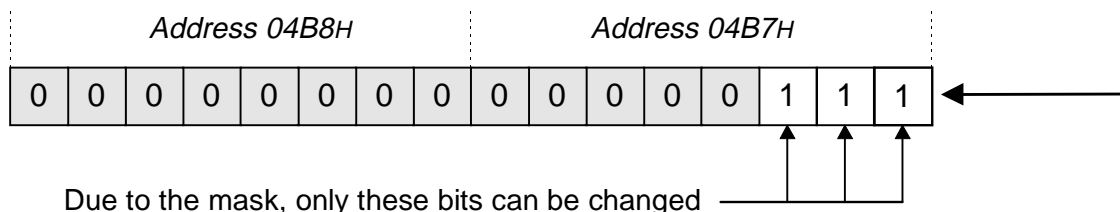

TOSHIBA

[W] Data write command

Writes data to the set address in the set bank. When writing to EEPROM addresses 03C0H ~ 04FEH (excluding 04D8H ~ 04F7H), both RAM and EEPROM contents are changed (for data setting limits, refer to the "Adjustment Range" columns of the communications data tables in section 9.4).

- The data response received after sending a "W" command is the actual (complete, unmasked) data at the address after writing (word length). This feature combines the write command with the function of the read command (see Example #1 below).
- The write command can only be used with RAM (bank 0) and EEPROM (bank 1).
- Address increment function: if a "+" character is included in the "W" command immediately following the data, the address is automatically post-incremented by 1 word (2 bytes), and the mask data returns to its initialization value of FFFFH. This feature can be used to write large blocks of data with a minimum number of commands.

<< Note >>

When a data write is performed, only that portion of the data that is within the mask limits is checked by the data checking routine (see Example #2 on page 28). If the data being written is outside of the adjustment limits associated with that address, an error is generated, and the data is not written. Please be sure to correctly set the mask before performing a data write. If the mask is not correctly set, the data cannot be correctly checked, which may result in data corruption or unpredictable inverter operation (data checking is not performed on certain parameters: refer to the communications data tables in section 9.4 for further information).

Caution

The EEPROM has a lifespan of 10,000 write cycles per address. Do not write to the same EEPROM (bank 1) address more than 10,000 times.

Example #1: Writing option commands (refer to page 58).

<u>HOST COMPUTER → INVERTER</u>	<u>INVERTER → HOST COMPUTER</u>
(00B0)	(00B0000) set bank to RAM
(00A50A)	(00A050A) option command address
(00R)	(00R0009) acc/dec #2, reverse, running
(00M4)	(00M0004) mask forward/reverse selection
(00W4)	(00W000D) forward (acc/dec #2, running)
(00R)	(00R0004) forward * ¹ (verify data)

*1: If only whether the inverter is running in forward or reverse is to be determined, the read command could be sent immediately after the mask command. Note that the data contained in the response to the write command is the complete, unmasked data at that address.

TOSHIBA

Example #2: Setting the frequency display resolution parameter (refer to FREQUENCY DISPLAY RESOLUTION in GROUP:UTILITY PARAMETERS in section 9.4).

HOST COMPUTER → INVERTER

INVERTER → HOST COMPUTER

(00B0)

(00B0000) set bank to RAM

(00A45D)

(00A045D) frequency display resolution address

(00R)

(00R3111)

(00M3)

(00M0003)

(00W6)

(00W3112)

- Mask overlaid on data prior to write

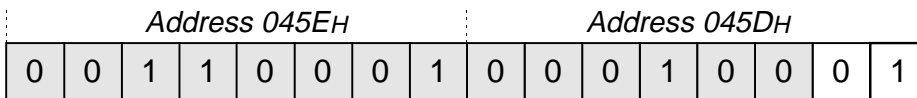

- Write data

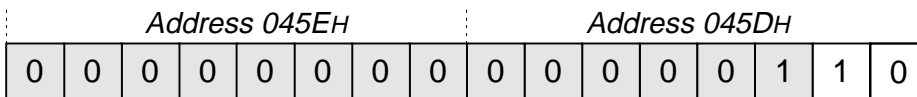

- Data after write

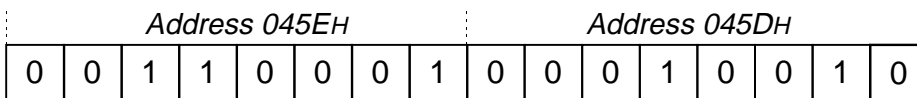

- The adjustment

range for the frequency display resolution parameter is 0 ~ 2, but because data checking is only performed on that portion of the data contained in the mask, the written data is viewed as 2. This is within the adjustment range and, therefore, no error occurs. The end result is that the frequency display resolution parameter setting is changed to 2 (0.01Hz).

[R] Data read command

Reads the data at the set address in the set bank. No data argument is required for this command: any included data is ignored.

- The data contained at the set address is returned as the data argument to the host computer. If the mask data is FFFFH, the returned data word is the complete data at the address. If the mask data is anything other than FFFFH, those bits set to 0 in the mask will be returned as 0's.
- Address increment function: if a "+" character is included in the "R" command, the address is automatically post-incremented by 1 word (2 bytes), and the mask data returns to its initialization value of FFFFH. This feature can be used to read large blocks of data with a minimum number of commands.

[T] Test command

Transmitted data (0 ~ 9, A ~ F) is returned unchanged to the host computer. Data adjustment range: 0000H ~ FFFFH.

TOSHIBA

7.7 Communication Examples

7.7.1 Communications Preparation

- (1) Install the RS485 board into an inverter and connect the communications cable (refer to section 2.2 Communications Cable Wiring).
- (2) Turn power to the inverter and host computer ON.
- (3) Check that the baud rate, number of data bits, parity, etc. are all set correctly, and then reset the inverter to validate the settings.
- (4) Run a communications interface application program on the host computer.

Communication should now be possible. The examples that follow were generated with the sample MS-DOS QBasic RS485 communications program shown in Example #2 of section 7.8 Example Host Computer Communication Programs.

(Note) If using the sample program directly, verify that the inverter's communication parameters (in GROUP:COMMUNICATION SETTING PARAMETERS) are set as follows (standard factory settings):

NUMBER OF DATA BITS..... 0 (7 bits)
 PARITY SETTING 0 (even parity)
 INVERTER ID NUMBER..... 0

The baud rate (9600 baud) is set by both parameter RS485 BAUD RATE in GROUP:COMMUNICATION SETTING PARAMETERS and jumpers J1 and J2 on the RS485 board. For the baud rate setting method, refer to section 9.1 Communications Specification.

Example: Switching to RS485 (option) command mode and frequency mode:

- Switching to communication option board input command mode (refer to page 84).

<u>HOST COMPUTER → INVERTER</u>	<u>INVERTER → HOST COMPUTER</u>
(00B1)	(00B0001) set bank to EEPROM
(00A4B7)	(00A04B7) command mode selection address
(00M7)	(00M0007) mask applicable bits
(00W3)	(00Wxxxx) select "option input valid"

- Switching to communication option board input frequency setting mode (refer to page 84).

<u>HOST COMPUTER → INVERTER</u>	<u>INVERTER → HOST COMPUTER</u>
(00B1)	(00B0001) set bank to EEPROM
(00A4B7)	(00A04B7) frequency mode selection address
(00M38)	(00M0038) mask applicable bits
(00W18)	(00Wxxxx) select "option input valid"

- Note that dependent upon the setting of the RS232C command/frequency mode selection (see page 59), the setting of the COMMAND MODE SELECTION and FREQUENCY MODE SELECTION parameters in the above example may have no effect on the actual command/frequency status (the RS232C command/frequency mode selection has priority). Even if the command/frequency mode is not set to option input, other functions such as parameter setting, inverter status monitoring, etc., can still be performed via RS485.

TOSHIBA

7.7.2 Timer Function

When the RS485 system is set up in a computer link configuration, a communications timer function can be used. When the communications timer is used, if communication does not take place within the set time limit, the inverter will trip ("OPTION PCB ERROR (PRESS CLEAR)" will be shown on the LCD display).

If it is desired to have the timer function active even after inverter control power is cycled OFF and ON, write the timer setting to EEPROM (bank 1). If it is desired to have the timer function disabled after inverter control power is cycled OFF and ON, write the timer setting to RAM (bank 0). The following example shows the remaining steps for setting the timer. (**NOTE**: Because the factory setting for the timer is 0000H, setting the STANDARD SETTING MODE SELECTION parameter in GROUP:UTILITY PARAMETERS to 3 (return to factory settings) will cause the timer setting to return to 0000H).

Ex: Setting the RS485 communications timer for computer link use (setting to 15 seconds):

<u>HOST COMPUTER → INVERTER</u>	<u>INVERTER → HOST COMPUTER</u>
(00A4CC)	(00A04CC) RS485 timer address
(00MFF)	(00M00FF) mask applicable bits
(00WF)	(00W××0F) set timer to 15 seconds
(00R)	(00R××0F) activate timer

< Timer adjustment range > 00H : timer OFF
01H ~ 64H : 1s ~ 100s

NOTE

- Setting the timer time alone does not activate the timer. The timer is activated by the first valid communication that occurs after the timer is set. If the timer setting is written to the EEPROM, the timer is activated by the first valid communication that occurs after the inverter is powered ON.
- If an inverter number error (number is only 1 character long, number does not match the inverter's set number), format error (parity error, overrun error, framing error), or checksum error occurs immediately after the timer time is set, this is not regarded as a valid communication, and the timer will not be activated / reset.
- To turn the timer function OFF, set the timer setting to "0". The timer will then be turned OFF upon the occurrence of the next valid communication (writing "0" to the timer setting alone will not turn the timer OFF).
- The timer used during peer-to-peer communications is fixed at 1 second. It is not related to the computer link timer function.

TOSHIBA

7.7.3 Examples

- Setting the option frequency command value:

<u>HOST COMPUTER → INVERTER</u>	<u>INVERTER → HOST COMPUTER</u>
(00B0)	(00B0000) select RAM (bank 0)
(00A508)	(00A0508) option frequency command address
(00R)	(00R1F40) currently set to 80.00Hz
(00W1770)	(00W1770) change to 60.00Hz

- Performing RUN/STOP commands:

<u>HOST COMPUTER → INVERTER</u>	<u>INVERTER → HOST COMPUTER</u>
(00B0)	(00B0000) select RAM (bank 0)
(00A50A)	(00A050A) option command address
(00M1)	(00M0001) mask RUN/STOP bit
(00W1)	(00Wxxxx) execute RUN command
(00W0)	(00Wxxxx) execute STOP command

- Monitoring the command mode status:

<u>HOST COMPUTER → INVERTER</u>	<u>INVERTER → HOST COMPUTER</u>
(00B0)	(00B0000) select RAM (bank 0)
(00A5B8)	(00A05B8) command mode status address
(00M3)	(00M0003) mask status bits
(00R)	(00R0002) command mode currently = option

- Switching to JOG mode:

<u>HOST COMPUTER → INVERTER</u>	<u>INVERTER → HOST COMPUTER</u>
(00B0)	(00B0000) select RAM (bank 0)
(00A50A)	(00A050A) option command address
(00M80)	(00M0080) mask JOG mode selection bit
(00W80)	(00Wxxxx) select JOG mode

- Selecting between acc/dec #1/#2 (setting acc/dec #2):

<u>HOST COMPUTER → INVERTER</u>	<u>INVERTER → HOST COMPUTER</u>
(00B0)	(00B0000) select RAM (bank 0)
(00A50A)	(00A050A) option command address
(00M8)	(00M0008) mask acc/dec #1/#2 selection bit
(00W8)	(00Wxxxx) select acc/dec #2

- Monitoring operating frequency:

<u>HOST COMPUTER → INVERTER</u>	<u>INVERTER → HOST COMPUTER</u>
(00B0)	(00B0000) select RAM (bank 0)
(00A524)	(00A0524) operating frequency monitor address
(00R)	(00R1770) inverter is running at 60.00Hz

TOSHIBA

- Monitoring the cumulative run time:

<u>HOST COMPUTER → INVERTER</u>	<u>INVERTER → HOST COMPUTER</u>
(00B0)	(00B0000) select RAM (bank 0)
(00A5D2)	(00A05D2) run time rollover bit address
(00M8)	(00M0008) mask run time rollover bit
(00R)	(00R0000) timer has not rolled over
(00A5A6)	(00A05A6) cumulative run time address
(00R)	(00R0064) timer is currently at 100 hours

- Executing emergency off command (inverter will trip):

<u>HOST COMPUTER → INVERTER</u>	<u>INVERTER → HOST COMPUTER</u>
(00B0)	(00B0000) select RAM (bank 0)
(00A50B)	(00A050B) option command address
(00M10)	(00M0010) mask emergency off command bit
(00W10)	(00Wxxxx) execute emergency off

- ✱ Because the inverter has tripped, all responses from the inverter will now have the inverter tripped “#” character included until a trip clear command is performed.

- Monitoring the present trip code:

<u>HOST COMPUTER → INVERTER</u>	<u>INVERTER → HOST COMPUTER</u>
(00B0)	(00B0000#) . . . select RAM (bank 0)
(00A591)	(00A0591#) . . . present trip monitor address (refer to Table 1 on page 64)
(00M7F)	(00M007F#) . . . mask trip code bits
(00R)	(00R0011#) . . . 11H = emergency off trip

- Performing reset (trip clear):

<u>HOST COMPUTER → INVERTER</u>	<u>INVERTER → HOST COMPUTER</u>
(00B0)	(00B0000#) . . . select RAM (bank 0)
(00A50B)	(00A050B#) . . . option command address
(00M20)	(00M0020#) . . . mask reset command bit
(00W20)	no response . . . reset

- ✱ Note that whether or not a response to the reset command is generated is dependent upon system and reset timing. After resetting, the RAM data, address and mask data, etc., will have returned to their initialized values, and the inverter tripped “#” character will no longer be included in the inverter responses.

- Executing “return to factory settings” (STANDARD SETTING MODE SELECTION = 3) command (can only be performed when the inverter is stopped):

<u>HOST COMPUTER → INVERTER</u>	<u>INVERTER → HOST COMPUTER</u>
(00B0)	(00B0000) select RAM (bank 0)
(00A4C2)	(00A04C2) standard setting mode address
(00M00FF)	(00M00FF) mask selection bits
(00W3)	(00Wxx03) 3 = return to factory settings

TOSHIBA

7.7.4 Address Increment Function Examples

Example #1: Parameter writing

- Writing MAXIMUM OUTPUT FREQUENCY, UPPER LIMIT FREQUENCY, LOWER LIMIT FREQUENCY, ACCELERATION TIME #1 and DECELERATION TIME #1 parameter settings using the address increment feature:

<u>HOST COMPUTER → INVERTER</u>	<u>INVERTER → HOST COMPUTER</u>
(00B1)	(00B0001) . . . select EEPROM (bank 1)
(00A3C0)	(00A03C0) . . . maximum frequency address
(00W1F40+)	(00W1F40+) . . . write 1F40H (80.00Hz) - address is then auto-incremented to 03C2H
(00W1F40+)	(00W1F40+) . . . write 80.00Hz to 03C2H (UPPER LIMIT FREQUENCY)
(00W0+)	(00W0000+) . . . write 0.00Hz to 03C4H (LOWER LIMIT FREQUENCY)
(00W64+)	(00W0064+) . . . write 10.0s to 03C6H (ACCELERATION TIME #1)
(00W64)	(00W0064) . . . write 10.0s to 03C8H (DECELERATION TIME #1)

- ✱ Note that because the data is being written to bank 1 (EEPROM) in the above example, the same data is also automatically written to bank 0 (RAM) (refer to page 27). When a data write is performed, data checking is also performed to ensure that the data is within the adjustment range specified in the data tables in section 9.4. If the address or data is out of its adjustment range, an error will be generated, and the data will not be valid (please note that data checking is not performed on those parameters in the data tables in section 9.4 whose mask and adjustment range columns are shaded). If a “+” character is included in the “W” command immediately following the data, the address is automatically post-incremented by 1 word (2 bytes).

Example #2: Parameter reading

- Reading MAXIMUM OUTPUT FREQUENCY, UPPER LIMIT FREQUENCY, LOWER LIMIT FREQUENCY, ACCELERATION TIME #1 and DECELERATION TIME #1 parameter settings using the address increment feature (assuming continuation from Example #1 above):

<u>HOST COMPUTER → INVERTER</u>	<u>INVERTER → HOST COMPUTER</u>
(00A3C0)	(00A03C0) . . . MAXIMUM OUTPUT FREQUENCY addr.
(00R+)	(00R1F40+) . . . read 1F40H (80.00Hz) - address is then auto-incremented to 03C2H
(00R+)	(00R1F40+) . . . read 80.00Hz from 03C2H
(00R+)	(00R0000+) . . . read 0.00Hz from 03C4H
(00R+)	(00R0064+) . . . read 10.0s from 03C6H
(00R)	(00R0064) . . . read 10.0s from 03C8H

These data values would be the same whether read from bank 0 (RAM) or bank 1 (EEPROM).

TOSHIBA

7.8 Example Host Computer Communication Programs

Program Development Notes

1. Because the G3 RS485 system operates in half-duplex mode (only 1 set of communication lines are used for both transmitting and receiving), the host computer will receive its own data after transmission, unless an RS232C to RS485 converter that has "ECHO ON/OFF" control is used. In order to avoid buffer overflow in "ECHO ON" mode, therefore, it is necessary to read the transmitted data from the computer's buffer in both broadcast and individual communications.
2. When broadcast communication is used, be sure to allow at least the minimum time interval between transmissions (refer to section 7.4 Communications Interval.) If an insufficient time interval is used, the data cannot be processed correctly by the inverter.
3. When individual communication is used, do not send the next data transmission until the previous transmission's response has been received. If data is transmitted before the previous transmission's response has been received, bus contention will occur.

Example #1: MS-DOS QBasic program which continuously monitors a user-input address (program written in MS-DOS QBasic Version 1.1 and executed on an IBM-compatible computer):

Program listing

```

OPEN "COM1:9600,E,7,1" FOR RANDOM AS #1 ---- 9600 baud, even parity, 7 data bits
INPUT "Inverter Number (00-99):"; A$ ---- input inverter number
INPUT "Monitor Address (0000-FFFF):"; C$ ---- input the address to monitor
B$ = "B0" ---- set RAM bank
C$ = "A" + C$ ---- build address (A) command
MonitorLoop:
  PRINT #1, "(" + A$ + B$ + ")" ---- transmit data packet to inverter
  INPUT #1, D$ ---- read transmitted data from buffer (see
  Program Development Note #1 at the top
  of this page: no echo control assumed)
  INPUT #1, D$ ---- read inverter response
  PRINT "Received Data = "; D$ ---- display the response
  B$ = C$ ---- advance command (B → A → R)
  C$ = "R" ---- set "R" command
GOTO MonitorLoop ---- loop forever ([CTRL] + [BREAK] exits)

```

Execution Example (operating frequency monitor)

```

Inverter Number (00-99):? 00
Monitor Address (0000-FFFF):? 524 ---- operating frequency monitor address
Received Data = (00B0000)
Received Data = (00A0524)
Received Data = (00R1770) ---- current operating frequency = 60.00Hz
Received Data = (00R1770)
Received Data = (00R1770)
:
:

```

TOSHIBA

Example #2: Sample MS-DOS QBasic RS485 communications program (program written in MS-DOS QBasic Version 1.1 and executed on an IBM-compatible computer) (**Note:** the following program cannot be used “as is” to perform broadcast communications):

Program listing

```
OPEN "COM1:9600,E,7,1" FOR RANDOM AS #1 ----- 9600 baud,even parity,7 data bits
CommLoop:
  INPUT "Send Data = ";B$ ----- input command to send
  PRINT #1,B$ ----- transmit command to inverter
  INPUT #1,A$ ----- read transmitted data from buffer
  INPUT #1,A$ ----- read inverter response
  PRINT "Received Data = ";A$ ----- display inverter response
GOTO CommLoop ----- loop forever ([CTRL] + [BREAK] exits)
```

Execution Example

```
Send Data =? (00A3C0) ----- maximum output frequency address
Received Data = (00A03C0)
Send Data =? (00W1770) ----- set maximum output frequency to 60.00Hz
Received Data = (00W1770)
Send Data =?
:
:
```

Example #3: Sample data conversion QBasic programs (programs written in MS-DOS QBasic Version 1.1 and executed on an IBM-compatible computer):

A) Decimal to hexadecimal conversion

Program listing

```
Start:
  INPUT "Decimal Data = "; A
  INPUT "Multiplier = "; B
  C$ = HEX$(A / B)
  PRINT "Hexadecimal Data = ";C$
GOTO Start
```

Execution Example

```
Decimal Data =? 60
Multiplier =? 0.01
Hexadecimal Data = 1770
Decimal Data =? 80
Multiplier =? 0.01
Hexadecimal Data = 1F40
:
:
```

B) Hexadecimal to decimal conversion

Program listing

```
Start:
  INPUT "Hexadecimal Data = "; A$
  INPUT "Multiplier = "; B
  A$ = "&H" + A$
  X = VAL(A$) * B
  PRINT "Decimal Data = "; X
GOTO Start
```

Execution Example

```
Hexadecimal Data =? 1F40
Multiplier =? 0.01
Decimal Data = 80
Hexadecimal Data =? 1770
Multiplier =? 0.01
Decimal Data = 60
:
:
```

TOSHIBA

Example #4: Sample MS-DOS QBasic RS485 communications program #2 (program written in MS-DOS QBasic Version 1.1 and executed on an IBM-compatible computer):

Program listing

```

DECLARE SUB TxRx (InvNum$, Comd$, Data$, RXdata$, CommErr%)
DIM BRT$, PRT$, BLN$, NUM$, CMD$, DAT$, rxd$, CommErr%

INPUT "Baud Rate ="; BRT$          ----- input baud rate
INPUT "Parity ="; PRT$            ----- input parity
INPUT "Length ="; BLN$           ----- input number of data bits
OPEN "COM1:" + BRT$ + "," + PRT$ + "," + BLN$ + ",1" FOR RANDOM AS #1
                                     ----- open communications port
CommLoop:                          ----- main program loop
  INPUT "Inverter Number ="; NUM$  ----- input inv. # ([CR] = broadcast)
  INPUT "Command ="; CMD$         ----- input command (A,R,W,M,B,T)
  INPUT "Data ="; DAT$           ----- input data
  CALL TxRx(NUM$, CMD$, DAT$, rxd$, CommErr%) ----- call main Tx/Rx subroutine
  IF CommErr% = 0 THEN            ----- OK/error check
    PRINT "Received Data = "; rxd$ ----- display received data if OK
  ELSE                             ----- else, indicate error
    PRINT "A Communications Error Has Occurred!"
  END IF
  PRINT                            ----- print blank line
GOTO CommLoop                      ----- loop ([CTRL]+[BREAK] exits)

SUB TxRx (InvNum$, Comd$, Data$, RXdata$, CommErr%) ----- main Tx/Rx subroutine
  DIM TXdata$, Sum&, I%, CKsum$, Retry%, CRcount%
  DIM RXbuf$, StartTime&, RXchar$

  TXdata$ = "(" + InvNum$ + Comd$ + Data$ + "&" ----- build checksum string
  Sum& = 0 ----- initialize checksum data
  FOR I% = 1 TO LEN(TXdata$)
    Sum& = Sum& + ASC(MID$(TXdata$, I%, 1)) ----- calculate checksum
  NEXT I%
  CKsum$ = RIGHT$(HEX$(Sum&), 2) ----- convert to characters
  TXdata$ = TXdata$ + CKsum$ + ")" ----- build complete Tx string
  Retry% = 0 ----- initialize retry counter

Txloop: ----- transmission loop
  IF LOC(1) <> 0 THEN RXchar$ = INPUT$(LOC(1), #1) ----- ensure Rx buffer is empty
  PRINT #1, Txdata$ ----- transmit data
  PRINT "Transmitted Data = "; Txdata$ ----- display transmitted data
  CRcount% = 0 ----- initialize [CR] Rx counter
  IF InvNum$ = "" THEN CRcount% = 1 ----- if broadcast, only 1 [CR]
  RXbuf$ = "" ----- initialize receive buffer
  StartTime& = TIMER ----- initialize 1s timer

Rxloop: ----- reception loop
  IF (TIMER - StartTime&) > 1 THEN ----- check for time-out (1s)

```

TOSHIBA

```

    Retry% = Retry% + 1          ----- increment retry counter
    IF Retry% < 3 THEN GOTO Txloop ----- 3 Tx attempts allowed
    CommErr% = 1                ----- indicate time-out error
    EXIT SUB                    ----- return to main program
END IF
IF (TIMER - StartTime&) < 0 THEN StartTime& = TIMER ----- timer overflow check
RXchar$ = ""                  ----- initialize received char
IF LOC(1) <> 0 THEN RXchar$ = INPUT$(1, #1) ----- if available, retrieve char

IF RXchar$ = CHR$(13) THEN ----- [CR] received?
    CRcount% = CRcount% + 1 ----- if yes, incr. [CR] counter
    RXdata$ = RXbuf$          ----- transfer received data
    RXbuf$ = ""              ----- initialize receive buffer
    IF LEFT$(RXdata$, LEN("(" + InvNum$ + Comd$)) = "(" + InvNum$ + ----- data packet error check
Comd$ THEN
        IF CRcount% < 2 THEN GOTO Rxloop ----- check [CR] Rx counter
        IF InvNum$ = "" THEN RXdata$ = "" ----- if broadcast, no Rx data
        CommErr% = 0          ----- indicate no error
        EXIT SUB              ----- return to main program
    ELSE
        PRINT "Error - Received Data = "; Rxdata$ ----- indicate data error
        Retry% = Retry% + 1 ----- increment retry counter
        IF Retry% < 3 THEN GOTO Txloop ----- 3 Tx attempts allowed
        CommErr% = 2          ----- indicate data error
        EXIT SUB              ----- return to main program
    END IF
ELSE
    RXbuf$ = RXbuf$ + RXchar$ ----- [CR] not retrieved
    GOTO Rxloop               ----- append char to data
    ----- continue receiving data
END IF

END SUB

```

TOSHIBA

Execution Example

```

Baud Rate =? 9600          ----- baud rate = 9600
Parity =? E                ----- even parity
Length =? 7                ----- 7 data bits
Inverter Number =? 00     ----- inv. number used (individual communications)
Command =? A              ----- set address data command
Data =? 3C0               ----- maximum frequency address
Transmitted Data = (00A3C0&95) ----- transmitted data packet
Received Data = (00A03C0&C5) ----- data response received OK
:
:
Inverter Number =?       ----- no inv. number used (broadcast communications)
Command =? A
Data =? 3C0
Transmitted Data = (A3C0&35)
Received Data =         ----- no response received after broadcast
:
:
Inverter Number =? 01    ----- example communications error
Command =? A
Data =? 3C0
Transmitted Data = (01A3C0&96)
Transmitted Data = (01A3C0&96)
Transmitted Data = (01A3C0&96) ----- 3 unsuccessful communication attempts
A Communications Error Has Occurred!
:
:

```

TOSHIBA

Program Comments

Main Program

Overview: Upon program startup, the communication parameters are entered and the communications port initialized. The main program loop is then initiated, where the target inverter number (or none, if a broadcast message), command, and data are entered. The transmit/receive subroutine is then called, and the response status displayed.

Variables: Input - BRT\$: baud rate
 PRT\$: parity (even = E, odd = O)
 BLN\$: number of data bits (7 or 8)
 NUM\$: inverter number (00 ~ 99, none)
 CMD\$: command (A, B, M, R, T, W)
 DAT\$: data (0000 ~ FFFF(+))

Output - rxd\$: received data

Internal - CommErr%: error code (0=no error, 1=time-out error, 2=data error)

- Notes:*
- The communications port to use is hard-coded as COM1.
 - If an inverter number (NUM\$) is used, it must be entered as 2 decimal numbers. To broadcast the message, hit the enter key at the inverter number prompt (NUM\$="").
 - To use the address increment feature (R/W commands only), append a "+" to the input data (DAT\$).

Transmit/Receive Subroutine

Overview: A checksum is calculated and added to the inverter number, command, and data, and then the combined message is transmitted. Receive processing is performed, and the response string is returned along with an error flag (code). Time-out and data error checks are performed, and retransmissions can occur up to a set limit of 3 times. If no inverter number was input (broadcast communication), no response message is received.

Variables: Input - InvNum\$: inverter number (00 ~ 99, none) (from main routine)
 Comd\$: command (A, B, M, R, T, W) (from main routine)
 Data\$: data (0000 ~ FFFF(+)) (from main routine)

Output - RXdata\$: received data (to main routine)
 ComErr%: error code (to main routine)

System - TIMER: system timer

Internal - TXdata\$: transmitted data string
 SUM&: checksum calculation buffer
 I%: checksum calculation loop counter
 CKsum\$: converted checksum string
 Retry%: transmission retry counter
 RXchar\$: received character buffer
 CRcount%: counter for number of [CR] characters received
 RXbuf\$: received message temporary buffer
 StartTime&: time-out start time

TOSHIBA

Notes: • Check the data before entering it into the main routine. This subroutine performs no error checking.

- If transmission speed is a concern, the checksum processing may be eliminated. The TXdata\$ variable would then become:

```
TXdata$ = "(" + InvNum$ + Comd$ + Data$ + ")"
```

- If communication error (inverter "N" code response) processing is desired, the line:

```
IF LEFT$(RXdata$, LEN("(" + InvNum$ + Comd$)) = "(" + InvNum$ + Comd$ THEN
```

can be replaced by the line:

```
IF (LEFT$(RXdata$, LEN("(" + InvNum$ + Comd$)) = "(" + InvNum$ + Comd$) OR (LEFT$(RXdata$, LEN("(" + InvNum$ + "N")) = "(" + InvNum$ + "N") THEN
```

RXdata\$ will then be returned with the error message, and CommErr% will be set to 0 (no error).

TOSHIBA

8. Peer-To-Peer Communication

8.1 Peer-To-Peer Communication Parameter Settings

Before using peer-to-peer communications, set the inverter parameters as shown below:

[1] Unblind the communication parameters:

- Set BLIND FUNCTION SELECTION in GROUP:UTILITY PARAMETERS to 1.
- Set COMMUNICATION PARAMS BLIND in GROUP:UTILITY PARAMETERS to 1.

[2] With the communication selection parameter, select RS485:

- Set COMMUNICATION SELECTION in GROUP:COMMUNICATION SETTING PARAMETERS to 1.

[3] Select the master and slave devices.

- 1) Select 1 inverter unit to be the master
(to avoid bus contention, be sure to set only 1 unit per system to be the master).
- 2) Select the type of frequency data that the master will transmit to the slaves.
(Note: Use caution when “master (frequency command)” is selected, because the slaves will start running if they are given run commands, regardless of whether or not the master is running).
 - To select the frequency command value, set MASTER/SLAVE SELECTION in GROUP:COMMUNICATION SETTING PARAMETERS to 1.
 - To select the output frequency, set MASTER/SLAVE SELECTION in GROUP:COMMUNICATION SETTING PARAMETERS to 2.
- 3) Set all other inverter units to be slaves:
 - Set MASTER/SLAVE SELECTION in GROUP:COMMUNICATION SETTING PARAMETERS to 0.

[4] Select the baud rate, number of data bits, and parity:

- Baud rate: set by RS485 BAUD RATE in GROUP:COMMUNICATION SETTING PARAMETERS and option board jumpers J1 and J2 (refer to section 9.1 Communications Specification).
- Number of data bits: set by NUMBER OF DATA BITS in GROUP:COMMUNICATION SETTING PARAMETERS.
- Parity: set by PARITY SETTING in GROUP:COMMUNICATION SETTING PARAMETERS.

[5] Set the frequency mode:

- 1) Master:
 - To use a terminal input frequency command value, set FREQUENCY MODE SELECTION in GROUP:UTILITY PARAMETERS to 1.
 - To use the panel input frequency command value, set FREQUENCY MODE SELECTION in GROUP:UTILITY PARAMETERS to 2.
- 2) Slaves:
 - Set FREQUENCY MODE SELECTION in GROUP:UTILITY PARAMETERS to 3.

[6] Set the command mode:

- To control RUN/STOP etc., via terminal input, set COMMAND MODE SELECTION in GROUP:UTILITY PARAMETERS to 1.
- To control RUN/STOP etc., via panel input, set COMMAND MODE SELECTION in GROUP:UTILITY PARAMETERS to 2.

TOSHIBA

8.2 Peer-To-Peer Communication Processing Flow

In peer-to-peer communications, the master inverter always transmits frequency (output frequency or frequency command) information to the slave inverters. The slaves are always in a state of waiting for frequency information from the master. From the time data is received until the data processing is completed, however, the slave inverters cannot receive additional data.

Inter-Inverter Communications

Ex: The master is operating at 100Hz, and all slaves connected to the system are also to operate at 100Hz (assume that no bias or gain settings are set, and that the maximum frequency of all inverters is set to 100Hz).

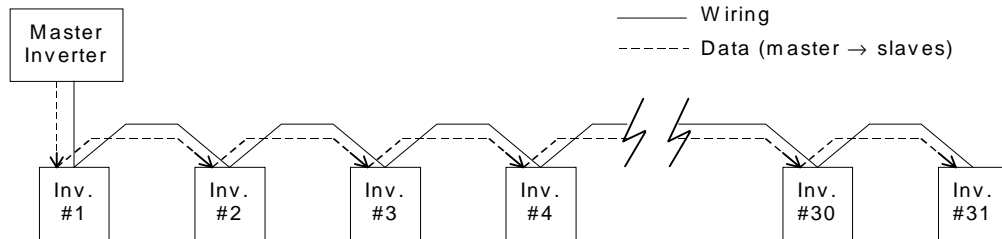

- (1) The master transmits a frequency command to the slaves. The data which the master transmits is: $\text{master frequency (frequency command or output frequency)} \times 10000 \div \text{master maximum frequency}$.
- (2) After the frequency command value has been processed by the proportionality calculations, the slaves write it to the option frequency command memory location (RAM (bank 0) address 0508H).

8.3 Sequence Explanation

(Master and slave data exchanges)

- (1) The master always transmits data - it cannot receive data.
- (2) The slaves always receive data - they cannot transmit data. Note that this also means that the slaves cannot transmit error responses (if an error occurs, the communications error alarm "COMM" will blink on and off on the slave's display panel until the next correct communication is received). Essentially, the data reception method of the slave inverters is identical to that of the inverters in a computer link system. The slaves ignore all characters received before a "(" character. If multiple "(" characters are received, only the last one received is valid, and all others are discarded.
- (3) Only when the slaves receive a carriage return code (0DH) is the transmission considered terminated.
- (4) If a time period of 1 second or longer passes without a transmission being received, the peer-to-peer communications timer will display the "COMM" alarm on the slave's display panel and write a value of 0Hz to the frequency command. The alarm will continue to blink on and off on the display panel until the next correct transmission is received (refer to section 8.7 Peer-To-Peer Communication Timer Function).
- (5) If the master trips, the "COMM" alarm will be displayed on the display panels of all slave units.
- (6) Simultaneous RS232C communication with both slaves and the master is possible while engaging in peer-to-peer communication, but depending on system timing conditions, the slaves may occasionally miss the start bits of the RS485 transmission. This may result in the communications alarm "COMM" occasionally being displayed. In addition, the communications response time will become longer.

Note: Always supply power to the slave units first, and then to the master.

TOSHIBA

8.4 Response Times

The maximum response time from when the frequency command is changed at the master until the slaves respond depends on the RS485 baud rate, bit length, and the following 2 conditions:

- 1) When neither the master nor slaves uses simultaneous RS232C communication.
- 2) When only the master uses simultaneous RS232C communication.

A diagram of the measurement method is shown below, and a table of the maximum response times is given on page 44. From the table, it is apparent that the shortest response time occurs when simultaneous RS232C communication is not used and the baud rate is set to 38400 baud. It is also apparent that the longest response time occurs when simultaneous RS232C communication takes place with the master, and RS485 communication settings are 1200 baud and 8 data bits. The table gives the absolute maximum response times: actual times will be shorter. The times shown with simultaneous RS232C communication assume that this is being performed only with the master: it is possible to perform simultaneous RS232C communications with slave inverters, but depending on system timing conditions, the slaves may occasionally miss the start bits of the RS485 transmission. This will result in the slave missing frequency data transmissions, and the communications response time will also become longer. Because of this, do not perform simultaneous RS232C communication with slave inverters unless absolutely necessary.

The frequency command value that is active at the start of a master processing cycle is the one that is processed and then transmitted during the next transmission cycle. If the master frequency command is changed after the start of a processing cycle, therefore, it must wait until the next cycle to be processed. Referring to the diagram below, if the master frequency command input is changed just slightly after point A, it will not be processed until the next master processing cycle (①). It will then be transmitted by the master (②), received by the slaves (③), and will become the new slave frequency command at the end of the slave processing cycle (point B). The maximum response time, therefore, is defined as B - A.

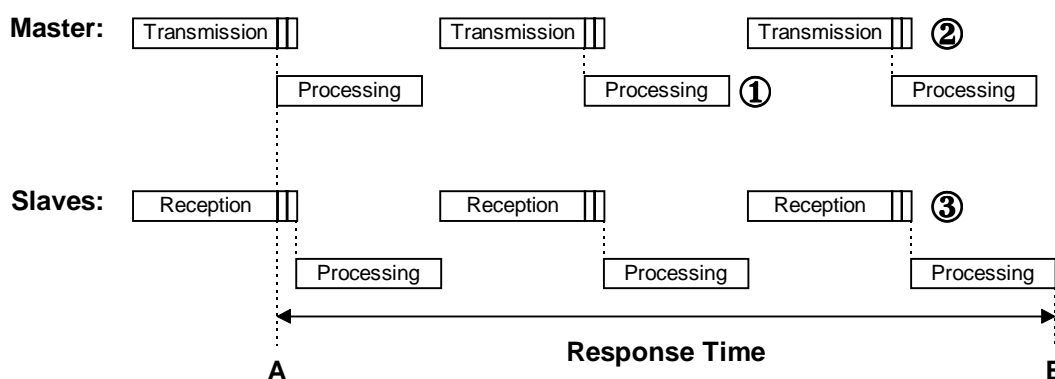

**Peer-To-Peer Communication:
Maximum Input-To-Slave Frequency Command Response Times**

Baud rate	7-Bit Length		8-Bit Length	
	No RS232C	RS232C	No RS232C	RS232C
1200 baud	260ms	273ms	285ms	295ms
2400 baud	142ms	165ms	153ms	176ms
4800 baud	82ms	111ms	93ms	116ms
9600 baud	61ms	84ms	63ms	86ms
19200 baud	47ms	70ms	48ms	71ms
38400 baud	40ms	63ms	41ms	64ms

The diagram below shows the derivation of the minimum update time, which is the shortest amount of time that the slave's frequency command value can change from one value to another. As can be seen in the diagram, the slave's frequency command value cannot be updated faster than B - A. The table below lists the minimum slave frequency command update times as a function of baud rate, bit length settings, and whether or not simultaneous RS232C communication is taking place with the master.

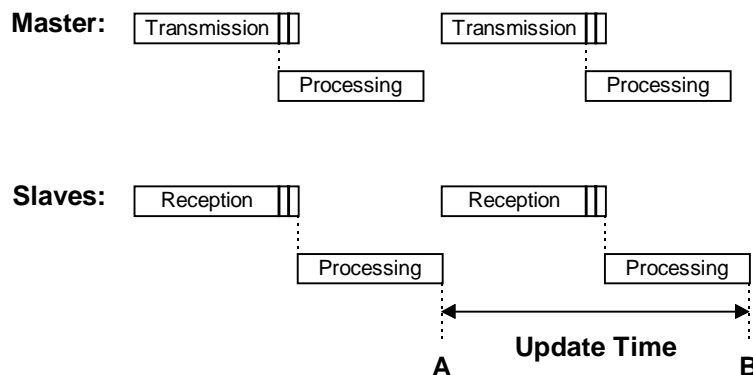

**Peer-To-Peer Communication:
Minimum Slave Frequency Command Update Times**

Baud rate	7-Bit Length		8-Bit Length	
	No RS232C	RS232C	No RS232C	RS232C
1200 baud	117ms	128ms	129ms	139ms
2400 baud	69ms	78ms	74ms	83ms
4800 baud	41ms	53ms	43ms	80ms
9600 baud	28ms	40ms	30ms	41ms
19200 baud	22ms	34ms	23ms	34ms
38400 baud	19ms	31ms	19ms	31ms

TOSHIBA

8.5 Transmission Format

All transmitted data is hexadecimal and conforms to ASCII (ANSI) standards.

Inverter (master) → inverter (slave)

1	2	3	4	5	6	7	8	9	10
“(“ (28H)	“S” (50H)	DATA				“&” (26H)	SUM		CR (0DH)

1. “(“ (1 character) Header code.
2. “S” (1 character) Peer-to-peer communication to slave inverter command.
3. DATA (4 characters) Data transmitted to the slaves (0000H ~ FFFFH).
4. “&” (1 character) Checksum indicator code.
5. SUM (2 characters) Checksum. ASCII-coded, least-significant 2-digit value (4 bits/digit) of the sum total addition of the ASCII code values from the header code to the checksum indicator code.
6. CR (1 character) Carriage return code.

Peer-To-Peer Communication Errors

Error determination during peer-to-peer communications is essentially the same as that during computer link communications, with the exception that when an error occurs, an error response is never sent (refer to section 9.2 Communication Errors).

TOSHIBA

Peer-To-Peer Communication Data Explanation

Master Processing

The data that the master transmits takes the form “Sxxxx”, where xxxx is the result of the equation:

$$[selected\ master\ frequency] \times 10000 \div [master\ maximum\ frequency]$$

When the master is tripped, a “#” character is also appended to the data.

Slave Processing

The 1-second peer-to-peer communication timer function is continually being executed. Bank 0 (RAM) and the address for option frequency command are automatically set, and the post-calculation data is written to this location (no data checking is performed). The data calculations performed are as follows:

- 1) When bias and gain settings are selected (RS485/12-BIT BINARY BIAS,GAIN in GROUP:COMMUNICATION SETTING PARAMETERS = 1), the following equation is used to determine the frequency command value:

$$frequency\ command = \frac{\left[\begin{array}{c} RS485 / 12 - BIT\ BINARY \\ PT. \#2\ FREQ \end{array} \right] - \left[\begin{array}{c} RS485 / 12 - BIT\ BINARY \\ PT. \#1\ FREQ \end{array} \right]}{\left[\begin{array}{c} RS485 / 12 - BIT \\ BINARY\ POINT\ \#2 \end{array} \right] - \left[\begin{array}{c} RS485 / 12 - BIT \\ BINARY\ POINT\ \#1 \end{array} \right]} \times \left(\frac{data}{100} - \left[\begin{array}{c} RS485 / 12 - BIT \\ BINARY\ POINT\ \#1 \end{array} \right] \right) + \left[\begin{array}{c} RS485 / 12 - BIT\ BINARY \\ PT. \#1\ FREQ \end{array} \right]$$

All parameters shown in the above equation are parameters in each slave inverter's GROUP:COMMUNICATION SETTING PARAMETERS.

- 2) When bias and gain settings are not selected (RS485/12-BIT BINARY BIAS,GAIN in GROUP:COMMUNICATION SETTING PARAMETERS = 0), the following equation is used to determine the frequency command value:

$$frequency\ command = (data \times [slave's\ maximum\ frequency]) \div 10000.$$

- 3) If a time-out occurs, the slave stops running (frequency command is set to 0Hz) and the communications alarm “COMM” will blink on and off on the LCD display panel.
- 4) If the master trips, the communications alarm “COMM” will blink on and off on the display panels of all slaves, but the data received from the master will continue to be processed as usual.

TOSHIBA

8.6 Proportional Control

By sending frequency information to up to 31 slave inverters, the master inverter controls the system's proportional operation (this feature is not used in computer link systems). This proportional operation is configured by a preset ratio in each slave inverter. There are 2 different methods to accomplish this, as explained below.

Problem: An RS485 peer-to-peer communication system is comprised of 1 master and 2 slave inverters. Slave #1 is to operate at 9/10 the master's operating frequency, and slave #2 is to operate at 8/10 the master's operating frequency.

Solution #1: Proportional control via maximum frequency ratios.

- 1) Do not enable the bias and gain settings (RS485/12-BIT BINARY BIAS ,GAIN in GROUP:COMMUNICATION SETTING PARAMETERS = 0).
- 2) Set the master's frequency command to 50Hz.
- 3) Set the master to transmit frequency command data (MASTER/SLAVE SELECTION in GROUP:COMMUNICATION SETTING PARAMETERS = 1), set the master and slave's MAXIMUM OUTPUT FREQUENCY parameters in GROUP:FUNDAMENTAL PARAMETERS #1 according to the following table, and the frequency command results will be as shown:

Inverter	MAXIMUM OUTPUT FREQUENCY	Frequency Command
Master	100.0Hz	50.0Hz (input)
Slave #1	90.0Hz	45.0Hz (result)
Slave #2	80.0Hz	40.0Hz (result)

- The data sent by the master is:

$$\begin{aligned}
 & \text{master frequency command} \times 10000 \div \text{master MAXIMUM OUTPUT FREQUENCY} \\
 & = 50 \times 10000 \div 100 \\
 & = 5000
 \end{aligned}$$

5000 in hexadecimal is 1388H, so the actual transmitted command will be (S1388&75.

- After the slave receives the command, it checks if the bias and gain parameters are enabled, and when they are not selected (as in this example), it calculates its frequency command as:

$$\text{frequency command} = \text{data} \times \text{MAXIMUM OUTPUT FREQUENCY} \div 10000$$

Therefore,

$$\text{Slave \#1: frequency command} = 5000 \times 90 \div 10000 = 45\text{Hz}$$

$$\text{Slave \#2: frequency command} = 5000 \times 80 \div 10000 = 40\text{Hz}$$

TOSHIBA

Solution #2: Proportional control via bias and gain settings.

- 1) Enable the slave's bias and gain settings (RS485/12-BIT BINARY BIAS ,GAIN in GROUP:COMMUNICATION SETTING PARAMETERS = 1).
- 2) Set the master's frequency command to 50Hz.
- 3) Set the master to transmit frequency command data (MASTER/SLAVE SELECTION in GROUP:COMMUNICATION SETTING PARAMETERS = 1), set the master and slave's MAXIMUM OUTPUT FREQUENCY, RS485/12-BIT BINARY POINT #1, RS485/12-BIT BINARY PT. #1 FREQ, RS485/12-BIT BINARY POINT #2, and RS485/12-BIT BINARY PT. #2 FREQ parameters according to the following table, and the frequency command results will be as shown:

Inverter	MAXIMUM OUTPUT FREQUENCY	RS485/12-BIT BINARY POINT #1	RS485/12-BIT BINARY PT. #1 FREQ	RS485/12-BIT BINARY POINT #2	RS485/12-BIT BINARY PT. #2 FREQ	Frequency Command
Master	100.0Hz	—	—	—	—	50.0Hz (input)
Slave #1	100.0Hz	0%	0.0Hz	100%	90.0Hz	45.0Hz (result)
Slave #2	100.0Hz	0%	0.0Hz	100%	80.0Hz	40.0Hz (result)

- The data sent by the master is:

$$\begin{aligned}
 & \text{master frequency command} \times 10000 \div \text{master MAXIMUM OUTPUT FREQUENCY} \\
 & = 50 \times 10000 \div 100 \\
 & = 5000
 \end{aligned}$$

5000 in hexadecimal is 1388H, so the actual transmitted command will be (S1388&75.

- After the slave receives the command, it checks if the bias and gain parameters are enabled, and when they are selected (as in this example), it calculates its frequency command as:

$$\text{frequency command} = \frac{\left[\text{RS485 / 12 - BIT BINARY PT. \#2 FREQ} \right] - \left[\text{RS485 / 12 - BIT BINARY PT. \#1 FREQ} \right]}{\left[\text{RS485 / 12 - BIT BINARY POINT \#2} \right] - \left[\text{RS485 / 12 - BIT BINARY POINT \#1} \right]} \times \left(\frac{\text{data}}{100} - \left[\text{RS485 / 12 - BIT BINARY POINT \#1} \right] \right) + \left[\text{RS485 / 12 - BIT BINARY PT. \#1 FREQ} \right]$$

$$\text{Slave \#1: frequency command} = \frac{90.0 - 0.0}{100 - 0} \times \left(\frac{5000}{100} - 0 \right) + 0.0 = 0.9 \times 50 = 45.0\text{Hz}$$

$$\text{Slave \#2: frequency command} = \frac{80.0 - 0.0}{100 - 0} \times \left(\frac{5000}{100} - 0 \right) + 0.0 = 0.8 \times 50 = 40.0\text{Hz}$$

8.7 Peer-To-Peer Communication Timer Function

When using computer link communications, the communications timer can be set between 1 ~ 100 seconds. The peer-to-peer communications timer, however, functions differently. When a slave inverter receives an “S” command (peer-to-peer frequency data command), it automatically sets its communications timer to 1 second. The timer function is then enabled until the inverter is re-initialized (control power is turned OFF and ON, a reset is performed, etc.) If a 1-second or longer length of time passes without the slave receiving a transmission, a time-out will occur. This will cause the communications alarm indicator “COMM” to blink on and off on the slave’s LCD display panel, and 0Hz will be written to the slave’s frequency command (the slave will stop). Once a time-out occurs, normal peer-to-peer communications will again begin upon the reception of the next “S” command. In the same way as the computer link timer, if an error occurs (format error, parity error, etc.), the communication will not be considered valid, and therefore will not restart peer-to-peer communications after a time-out.

TOSHIBA

9. Appendix

9.1 Communications Specification

Item	Specification
Applicable Inverter	TOSHIBA TOSVERT-130 G3
Communication System	Half-duplex, 2-wire system
Connection Control System	Centralized control system ^{*1}
Synchronization Method	Start-stop synchronization (1 stop bit)
Communication Speed	Default setting: 9600 baud 1200/2400/4800/9600/19200/38400 baud selectable ^{*2}
Communication Code	Default setting: 7-bit (ASCII) ^{*3} , even parity ^{*3} 7/8 -bit ^{*4} , even/odd parity ^{*4} selectable
Character Format	10-bit or 11-bit ^{*5}
Error Detection Methods	Parity, checksum
Error Correction Method	None
Response Observation Method	None
Bit Transmission Order	LSB first
Frame Length	Variable (15 bytes maximum)
Interface	Conforms to EIA RS485 standard
Communication Distance	1000m maximum
Connection Points	32 units maximum (including host)
Other	Time-out function available. When a communication error occurs, alarm indicator is a blinking "COMM" on the LCD display.

TOSHIBA

NOTES:

*1: Centralized control system

The controlling equipment master (host) controls all of the connected slave (G3) units, and data transmission is allowed only between the master and the slave units. The master transmits data to a G3 unit, and the G3 transmits its response, according to the communication process outlined in this manual.

*2: Baud rate selection method

Factory-shipped setting is normal mode, J1 & J2 OFF (9600 baud).

Jumper Settings		RS485 BAUD RATE	
J1	J2	Normal Mode (0)	High-Speed Mode (1)
OFF	OFF	9600	38400
ON	OFF	4800	19200
OFF	ON	2400	9600
ON	ON	1200	4800

NOTE: 9600 baud and 4800 baud can be selected in both normal and high-speed mode. There is no difference in operation in either mode.

*3: Communication Code

All character codes conform to the ASCII (ANSI) standard for 7-bit alphanumeric characters (refer to section 9.5 ASCII Character Codes). With standard settings, an even parity bit is also added. Via parameter settings, 8-bit data length and odd parity selections are also available.

*4: Bit Length / Parity

The bit length and parity settings are shared with RS232C communications. When simultaneously using RS232C communications, therefore, please use the same bit length and parity.

- Bit length: NUMBER OF DATA BITS in GROUP:COMMUNICATION SETTING PARAMETERS (0 = 7 bits, 1 = 8 bits).
- Parity: PARITY SETTING in GROUP:COMMUNICATION SETTING PARAMETERS (0 = even parity, 1 = odd parity).

*5: Character Formats

1) 10-bit (7 bits + parity) (standard factory-shipped setting)

START BIT	BIT 0	BIT 1	BIT 2	BIT 3	BIT 4	BIT 5	BIT 6	PARITY BIT	STOP BIT
-----------	-------	-------	-------	-------	-------	-------	-------	------------	----------

2) 11-bit (8 bits + parity)

START BIT	BIT 0	BIT 1	BIT 2	BIT 3	BIT 4	BIT 5	BIT 6	BIT 7	PARITY BIT	STOP BIT
-----------	-------	-------	-------	-------	-------	-------	-------	-------	------------	----------

TOSHIBA

9.2 Communication Errors

When a communication error occurs, the communication error alarm “COMM” will be displayed on the operating panel, and if the transmission was not a broadcast, the error code corresponding to the error that occurred will be returned (refer to the table below and section 7.5.2 Data Responses From Inverter To Host Computer).

Error Name	Error Description	Error Code
Cannot execute	communication was correct, but cannot execute command (attempt to write a parameter that cannot be written while inverter is running * ¹ , EEPROM error)	0000
Data error	data setting value outside of adjustment range, character other than a <CR> received after the “)”, data exceeded 4 characters, data not in the range of “0” ~ “9” or “A” ~ “F”, character other than “&”, “)”, <CR>, or “+” (only during read/write commands) received after data	0001
Address error	address data outside of adjustment range when a “W” command was sent, attempt to write data at a protected address * ² , bank setting was incorrect when a read/write was performed	0002
Command error	command was incorrect	0003
Checksum error	checksum was incorrect, character other than “)” or <CR> received after the checksum data (includes the case of the checksum data exceeding 2 characters)	no response * ⁴
Format error	communications format was incorrect (parity error, overrun error, framing error) * ³	no response * ⁴
Inverter number error	inverter number was incorrect, inverter number was only 1 character long	no response * ⁴

*¹: Parameters that cannot be set while the inverter is running are MAXIMUM OUTPUT FREQUENCY, BASE FREQUENCY VOLTAGE SELECT, VOLTS PER HERTZ PATTERN, STANDARD SETTING MODE SELECTION, and INDUSTRIAL APPLICATIONS.

*²: The following RAM and EEPROM locations cannot be written to:
04D8H ~ 04F7H, 0500H ~ 0507H (RAM only), 04FAH bits 4 and 5, 04FBH bit 7, 050AH bits 4 and 5 (RAM only), 050BH bit 7 (RAM only), 0512H bits 4 and 5 (RAM only), 0513H bit 7 (RAM only).

*³: Parity error:..... parity incorrect
Overrun error:... new data received before previous data could be read from buffer
Framing error:... stop bit position incorrect

*⁴: Due to the possibility of bus contention, the inverter will not respond when an inverter number error, format error, or checksum error occurs.

TOSHIBA

RS485 Communication Error Priority Rankings

1. Format error
2. Inverter number error
3. Checksum error
4. Command error
5. Data error (incorrect data: data characters other than "0" ~ "9", "A" ~ "F", data length exceeds 4 characters, character other than "+" (only during a R/W command), "&", "("), or <CR> after the data, or character other than <CR> after the ")" character)
6. Address error (only R/W commands)
7. Cannot execute error (only "W" command)
8. Data error (data outside of setting limits during "W" command, attempt to write to a protected location, or bank data outside of limits during "B" command)

Response Data Matrix

Interface		RS232C		RS485	
Inverter number		Yes	No	Yes	No
Normal communications		○	○	○	×
When an error occurs	Cannot execute error	○	○	○	×
	Data error	○	○	○	×
	Address error	○	○	○	×
	Command error	○	○	○	×
	Checksum error	×	○	×	×
	Format error	×	□	×	×
	Inverter number error	×	×	×	×

○ Response transmitted.

×..... Response not transmitted.

□..... Response transmitted when the "(" character is correctly received. When the "(" character is not correctly received, the data is discarded and therefore no response is transmitted.

TOSHIBA

“COMM” Alarm Causes

- 1) During computer link communications
 - When any previously-mentioned communication error occurs.
- 2) During peer-to-peer communications (pertains only to slaves)
 - When any previously-mentioned communication error occurs.
 - When a communications timer time-out occurs.
 - When the master inverter trips.

RS485 Option-Related Trips

OPTION PCB ERROR (PRESS CLEAR)

- During computer link communications, when the communications timer is set and a time-out occurs (if a time-out occurs during peer-to-peer communications, the inverter will not trip, but will only stop operation and display the “COMM” alarm).
- When RS485 communication is selected (COMMUNICATION SELECTION in GROUP:COMMUNICATION SETTING PARAMETERS = 1), and the RS485 option board is not installed (or is installed improperly), or a different option board is installed.
- When the RS485 option board is damaged.

9.3 Memory Configuration

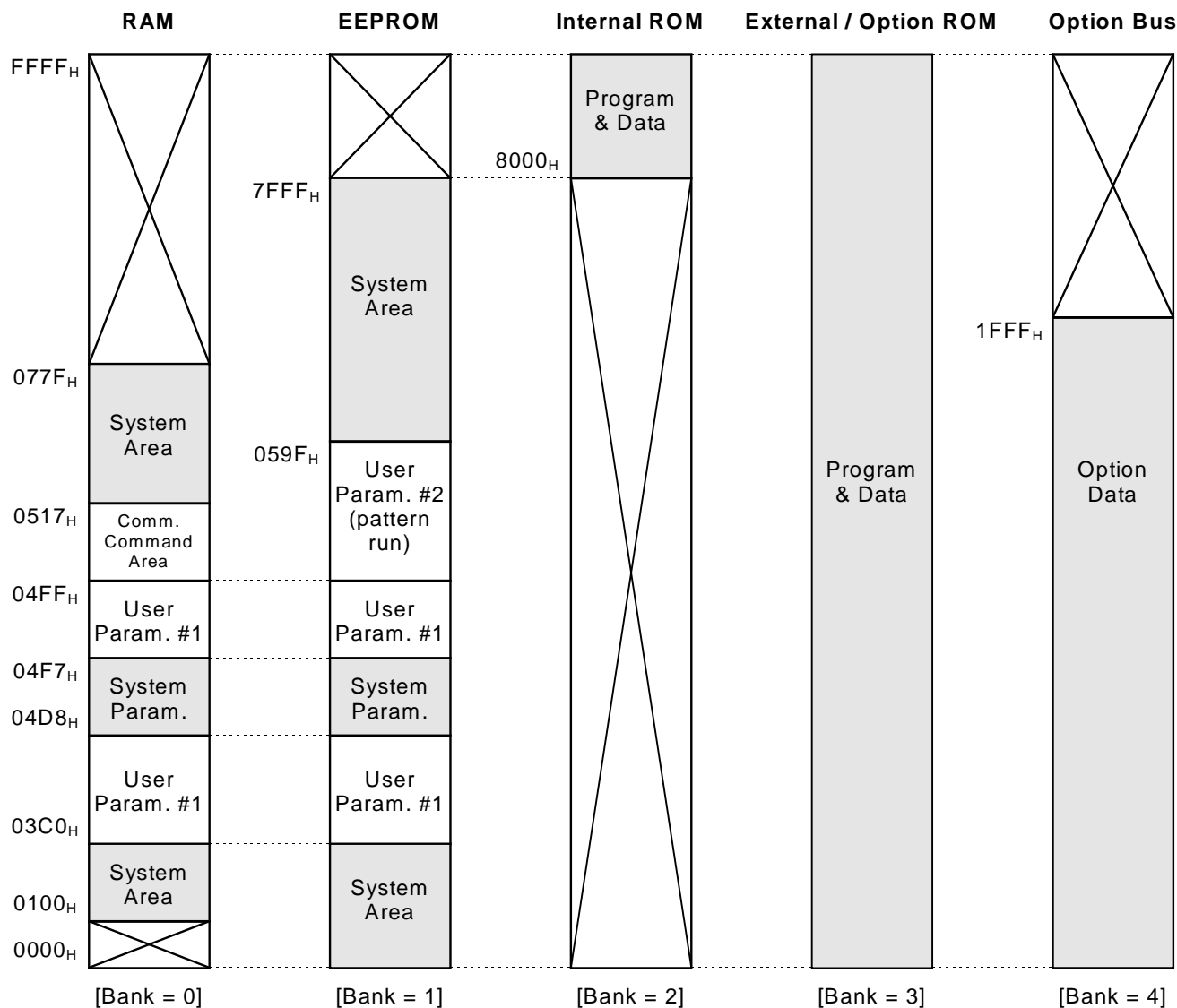

RAM: Contains parameter settings and other data that the inverter uses for system control (parameters, commands, status, etc.) When the inverter is powered-off, this data is erased. When the inverter is powered-on, parameter data is copied from EEPROM to RAM (directly in the case of User Param. #1). Other data is initialized.

EEPROM: Contains user-set parameters and other data. This data is retained even when the inverter is powered-off.

Internal ROM: Contains control programming and internal ROM version information.

External ROM: Contains control programming and external ROM version information.

Option Bus: Allows access to data contained in installed options.

TOSHIBA

<< **Note** >> Shaded areas cannot be written to (read-only). Also, do not attempt to access those areas crossed out with an "X".

TOSHIBA

9.4 Communications Data Tables

- Symbol Definitions**

(#): Depends on inverter rating.

(*): Cannot be set while inverter is running (attempting to write data while the inverter is running will result in an error (N0000)).

(Note): Use caution! Because there is no data checking performed on these settings, caution must be used to not write incorrect data (the “Mask” and “Adjustment Range” sections will be shaded).

- Usage Precautions**

- 1: Refer to the inverter instruction manual in conjunction with this manual.
- 2: If the mask data is not correctly set when data is written, the data check function cannot correctly check the data setting.
- 3: All data is written in hexadecimal (base 16) format (except for “Multiplier” and “Adjustment Range” data, which is written in decimal (base 10) format).

Parameter Table Usage Method Example

GROUP : FUNDAMENTAL PARAMETERS #1

Function / Title	Bank	Address	Mask	Adjustment Range	Multiplier
MAXIMUM OUTPUT FREQUENCY (*)	0 / 1	03C0	FFFF	0BB8 ~ 9C40 (30.00 ~ 400.00)	0.01
BASE FREQUENCY #1	0 / 1	0428	FFFF	09C4 ~ 9C40 (25.00 ~ 400.00)	0.01

◇ In this example, the MAXIMUM OUTPUT FREQUENCY setting of the inverter numbered “00” will be changed from 80Hz to 60Hz.

HOST COMPUTER → INV. INV. → HOST COMPUTER

(00B0) (00B0000).....Bank

(00A3C0) (00A03C0).....Address

(00MFFFF) (00MFFFF).....Mask

(00W1770) (00W1770).....Data (within adjustment range)

(Since the mask is automatically set to FFFFH whenever the address is set, setting it as shown here is optional).

- Panel display range (base 10)**

The actual value displayed on the LCD panel will depend on the setting of FREQUENCY DISPLAY RESOLUTION in GROUP : UTILITY PARAMETERS. When 0.01Hz resolution is selected and the above example is performed, 60.00Hz will be displayed on the panel. When 0.1Hz resolution is selected, 60.0Hz will be displayed. The “Adjustment Range” column shows a maximum of 5 digits, but because the panel can only display 4 digits, the displayed value will be a rounded representation of the actual data setting value.

(Ex: If 399.95 (9C3BH) is written to MAXIMUM OUTPUT FREQUENCY (upper limit=400.00), 400.0Hz will be displayed).

- Display Data / Internal Data Conversion Method**

Internal data = [display data ÷ Multiplier], converted to hexadecimal.

(Ex: To convert a MAXIMUM OUTPUT FREQUENCY setting of 60Hz to internal data: 60 ÷ 0.01 = 6000, converted to hexadecimal → 1770H).

- Shaded Parameters**

Data checks are not performed on parameters that appear in the following data tables with shaded “Mask” and “Adjustment Range” sections. Use extreme caution when setting these parameters, therefore, as incorrect mask or data settings may cause unpredictable operation.

TOSHIBA

Option Command / Frequency

<< The following function is valid only when FREQUENCY MODE SELECTION in GROUP:UTILITY PARAMETERS is set to 3 (communication/12-bit binary option input valid). >>

Group	Function	Bank	Address	Mask	Adjustment Range	Multiplier	Initialized Value
Option	Frequency command	0	0508	FFFF	LL ~ UL (Note 1)	0.01	0000

<< The following functions are valid only when COMMAND MODE SELECTION in GROUP:UTILITY PARAMETERS is set to 3 (communication option input valid). >>

Group	Function	Bank	Address	Mask	Adjustment Range	Multiplier	Initialized Value
Option Command	Run • stop command selection	0	050A	0001	0000: Stop command 0001: Run command	—	0000
	Forward • reverse run selection	0	050A	0004	0000: Reverse 0004: Forward	—	0004 (Note 2)
	Acc/dec #1 / #2 selection	0	050A	0008	0000: Acc / dec #1 0008: Acc / dec #2	—	0000
	Jog mode selection	0	050A	0080	0000: Normal (acc/dec mode) 0080: Jog mode	—	0000
	Feedback control (Note 3)	0	050B	0001	0000: Feedback valid 0001: Feedback invalid	—	0000
	Compulsory DC injection braking mode	0	050B	0002	0000: No compulsory DC injection braking 0002: Compulsory DC injection below DC INJECTION START FREQUENCY	—	0000
	Fundamental parameter switching	0	050B	0004	0000: V/F #1 0004: V/F #2	—	0000
	Gate block command (coast stop command)	0	050B	0008	0000: Normal 0008: Gate block	—	0000
	Emergency off command	0	050B	0010	0000: Does nothing 0010: Emergency off	—	0000
	Reset command (trip clear)	0	050B	0020	0000: Does nothing 0020: Reset	—	0000
	Preset speed run command	0	050C	000F	0000: Output frequency selected by FREQUENCY MODE SELECTION 0001 ~ 000F: speeds 1 ~ 15	1	0000

Group	Function	Bank	Address	Mask	Adjustment Range	Multiplier	Initialized Value
RS485	RS485 communications timer	0 / 1	04CC	00FF	0000: Timer OFF 0001 ~ 0064: 1s ~ 100s	1	EEPROM contents

(Note 1) Throughout the remainder of this document, the abbreviations “LL”, “UL”, and “Fmax” will stand for LOWER LIMIT FREQUENCY, UPPER LIMIT FREQUENCY, and MAXIMUM OUTPUT FREQUENCY, respectively.

(Note 2) The initialized value is 0004 only when an option ROM is installed and a communications option (RS485, TOSLINE-F10, TOSLINE-S20, DeviceNet or RIO) is selected (COMMUNICATION SELECTION in GROUP:COMMUNICATION SETTING PARAMETERS = 1 ~ 3). Otherwise, it is initialized to 0000.

(Note 3) This parameter only selects whether or not feedback control is valid when feedback control is selected. In order to use feedback control, parameter FEEDBACK CONTROL SELECTION in GROUP:FEEDBACK CONTROL PARAMETERS must still be set.

TOSHIBA

RS232C Command / Frequency

<< RS232C commands/frequency command will only be valid when the following parameter is respectively configured for RS232C command, frequency, or both. >>

Group	Function	Bank	Address	Mask	Adjustment Range	Multiplier	Initialized Value
RS232C	Command • frequency mode selection	0	0515	0003	0000: FREQUENCY MODE SELECTION, COMMAND MODE SELECTION settings 0001: RS232C commands valid 0002: RS232C frequency valid 0003: RS232C commands and frequency valid	—	0000

Group	Function	Bank	Address	Mask	Adjustment Range	Multiplier	Initialized Value
RS232C	Frequency command	0	0510	FFFF	LL ~ UL	0.01	0000

Group	Function	Bank	Address	Mask	Adjustment Range	Multiplier	Initialized Value
RS232C Command	Run • stop command selection	0	0512	0001	0000: Stop command 0001: Run command	—	0000
	Forward • reverse run selection	0	0512	0004	0000: Reverse 0004: Forward	—	0004
	Acc/dec #1 / #2 selection	0	0512	0008	0000: Acc / dec #1 0008: Acc / dec #2	—	0000
	Jog mode selection	0	0512	0080	0000: Normal (acc/dec mode) 0080: Jog mode	—	0000
	Feedback control (Note 1)	0	0513	0001	0000: Feedback valid 0001: Feedback invalid	—	0000
	Compulsory DC injection braking mode	0	0513	0002	0000: No compulsory DC injection braking 0002: Compulsory DC injection below DC INJECTION START FREQUENCY	—	0000
	Fundamental parameter switching	0	0513	0004	0000: V/F #1 0004: V/F #2	—	0000
	Gate block command (coast stop command)	0	0513	0008	0000: Normal 0008: Gate block	—	0000
	Emergency off command	0	0513	0010	0000: Does nothing 0010: Emergency off	—	0000
	Reset command (trip clear)	0	0513	0020	0000: Does nothing 0020: Reset	—	0000
	Preset speed run command	0	0514	000F	0000: Output frequency selected by FREQUENCY MODE SELECTION 0001 ~ 000F: speeds 1 ~ 15	1	0000

Group	Function	Bank	Address	Mask	Adjustment Range	Multiplier	Initialized Value
RS232C	RS232C communications timer	0 / 1	0445	00FF	0000: Timer OFF 0001 ~ 0064: 1s ~ 100s	1	EEPROM contents

(Note 1) This parameter only selects whether or not feedback control is valid when feedback control is selected. In order to use feedback control, parameter FEEDBACK CONTROL SELECTION in GROUP: FEEDBACK CONTROL PARAMETERS must still be set.

TOSHIBA

Panel Command / Frequency

<< The following function is valid only when FREQUENCY MODE SELECTION in GROUP:UTILITY PARAMETERS is set to 2 (panel input valid) or 4 (local/remote changeover possible). >>

Group	Function / Title	Bank	Address	Mask	Adjustment Range	Multiplier
Panel	FREQUENCY COMMAND	0	04F8	FFFF	LL ~ UL	0.01

<< The following functions are valid only when COMMAND MODE SELECTION in GROUP:UTILITY PARAMETERS is set to 2 (panel input valid) or 4 (local/remote changeover possible). >>

Group	Function / Title	Bank	Address	Mask	Adjustment Range	Multiplier
Panel Command	Run • stop command selection	0 (Note 1)	04FA	0001	0000: Stop command 0001: Run command	—
	DIRECTION SELECTION (FORWARD/REV)	0 / 1	04FA	0004	0000: Reverse 0004: Forward	—
	ACCEL/DECEL #1/#2 SELECTION	0 / 1	04FA	0008	0000: Acc / dec #1 0008: Acc / dec #2	—
	Jog mode selection	0 (Note 1)	04FA	0080	0000: Normal (acc/dec mode) 0080: Jog mode	—
	PANEL FEEDBACK CONTROL (Note 2)	0 / 1	04FB	0001	0000: Feedback valid 0001: Feedback invalid	—
	Compulsory DC injection braking mode	0 (Note 1)	04FB	0002	0000: No compulsory DC injection braking 0002: Compulsory DC injection below DC INJECTION START FREQUENCY	—
	FUNDAMENTAL PARAM SWITCHING	0 / 1	04FB	0004	0000: V/F #1 0004: V/F #2	—
	Gate block command	0 (Note 1)	04FB	0008	0000: Normal 0008: Gate block	—
	Emergency off command	0 (Note 1)	04FB	0010	0000: Does nothing 0010: Emergency off	—
	Reset command	0 (Note 1)	04FB	0020	After writing 0020 ("TRIP CLEAR COMMAND (PRESS CLEAR)") will be displayed), write 0000 and the inverter will reset	—
	Preset speed run command	0 (Note 1)	04FC	000F	0000: Output frequency selected by FREQUENCY MODE SELECTION 0001 ~ 000F: speeds 1 ~ 15	1

(Note 1) It is also possible to write to bank 1 (EEPROM), but this is not for normal command use. To avoid the possibility of unpredictable operation, do not write these commands to bank 1.

(Note 2) This parameter only selects whether or not feedback control is valid when feedback control is selected. In order to use feedback control, parameter FEEDBACK CONTROL SELECTION in GROUP:FEEDBACK CONTROL PARAMETERS must still be set.

TOSHIBA

Inverter Status Monitor (Read Only)

Function	Bank	Address	Mask	Data Length	Contents (Units)	Multiplier
Operating frequency monitor	0	0524	FFFF	word	Hz	0.01
Rotation direction monitor	0	05B6	0004	bit	→ <i>inverter status monitor 1</i>	—
Frequency command monitor	0	0500	FFFF	word	Hz	0.01
Output current monitor	0	0576	00FF	byte	%	1
Input voltage monitor (Note 1)	0	05B2	FFFF	word	%	0.1
Output voltage monitor (Note 1)	0	05B0	FFFF	word	%	0.1
Input terminal status monitor	0	057A	FFFF	word	→ <i>bit monitor 1</i>	—
Output terminal status monitor	0	0579	00FF	byte	→ <i>bit monitor 2</i>	—
Cumulative run time (Note 2)	0	05A6	FFFF	word	—	1
		05D2	0008	bit	—	1
Past trips (Note 3) (4 most recent trips)	0 / 1	04F3 ~ 04F7	007F	5 bytes	→ <i>Table 1, Table 2</i>	—
Pre-compensation frequency	0	0524	FFFF	word	Hz	0.01
Post-compensation frequency	0	0260	FFFF	word	Hz	0.01
Torque current monitor	0	0684	FFFF	word	% (Note 4)	0.01
Excitation current monitor	0	0688	00FF	byte	%	1
PID feedback value	0	0506	FFFF	word	Hz (Note 4)	0.02
Motor overload ratio	0	0584	FFFF	word	%	(Note 5)
Inverter overload ratio	0	0586	FFFF	word	%	(Note 5)
DBR overload ratio	0	0588	FFFF	word	%	(Note 5)
Input / output power units	0	03AE	0008	bit	0000: 0.01kW 0008: 0.1kW	(Note 6)
Input power (%) (Note 7)	0	035C	FFFF	word	%	0.1
Input power (kW)	0	0350	FFFF	word	kW	(Note 6)
Output power (%) (Note 7)	0	035E	FFFF	word	% (Note 4)	0.1
Output power (kW)	0	0352	FFFF	word	kW (Note 4)	(Note 6)
RR input	0	0550	FFFF	word	%	(Note 5)
Present trip	0	0591	007F	byte	→ <i>Table 1</i>	—
Command mode status	0	05B8	0003	2 bits	00: terminal 01: panel 02: option 03: RS232C	—
Frequency mode selection status	0	05B8	000C	2 bits	00: terminal 04: panel 08: option 0C: RS232C	—
CPU version number	2	8000	FFFF	word	—	1
External ROM version number	3	0000	FFFF	word	—	1
EEPROM version number	1	0380	FFFF	word	—	1
Inverter typeform monitor	0	05CA	00FF	byte	→ <i>Table 5</i>	1

(Note 1) These monitor voltage units are not affected by the setting of VOLTAGE UNITS SELECTION in GROUP:UTILITY PARAMETERS - they are always in %.

(Note 2) The time range for the cumulative run timer is 0000H ~ FFFFH (0 ~ 65535 hours), counted at address 05A6 in bank 0. When the timer reaches a count of 65536, bit 3 of address 05D2 in bank 0 is set, and the count at address 05A6 is cleared. At a count of 65537, therefore, address 05A6 will contain 0001H and bit 3 of address 05D2 will be set.

Cumulative run time monitor example (reading value from inverter number "00"):

HOST COMPUTER → INVERTER

(00A5D2)
(00M0008)
(00R)
(00A5A6)
(00R)

INVERTER → HOST COMPUTER

(00A05D2) select rollover bit address
(00M0008) mask off rollover bit
(00R0008) timer has rolled-over (≥ 65536 hours)
(00A05A6) select timer address
(00R000A) timer = 10 (total time = 65546 hours)

TOSHIBA

- (Note 3) Past trips are stored in a ring-buffer format, with the most recent trip located at the address following the 00H starting point.
- (Note 4) Uses signed data (data values larger than 7FFFH are negative). If internal data is 8000H or larger, the actual value can be obtained by: **actual value = - [FFFFH - (internal data) + 1]**.
- (Note 5) Multiplier is 100/65535.
- (Note 6) If the input / output power units data is 0000, the monitored data is in 0.01kW units, and the multiplier is 0.01. If the input / output power units data is 0008, the monitored data is in 0.1kW units, and the multiplier is 0.1. These values are automatically set according to the inverter typeform.
- (Note 7) $100\% = \sqrt{3} \times \text{rated voltage} \times \text{rated current}$ (with some variation for losses).

Input Terminal Status Monitor

Bit Monitor 1 Lower Byte	057AH	Input Terminal	0	1	Single-Bit Read Mask
bit 0		F	terminal - CC open	terminal - CC shorted	0001
bit 1		R	terminal - CC open	terminal - CC shorted	0002
bit 2		S1	terminal - CC open	terminal - CC shorted	0004
bit 3		S2	terminal - CC open	terminal - CC shorted	0008
bit 4		S3	terminal - CC open	terminal - CC shorted	0010
bit 5		S4	terminal - CC open	terminal - CC shorted	0020
bit 6		S5 (option)	terminal - CC open	terminal - CC shorted	0040
bit 7		S6 (option)	terminal - CC open	terminal - CC shorted	0080

Bit Monitor 1 Upper Byte	057BH	Input Terminal	0	1	Single-Bit Read Mask
bit 0		unused (always 0)	—	—	—
bit 1		unused (always 0)	—	—	—
bit 2		unused (always 0)	—	—	—
bit 3		unused (always 0)	—	—	—
bit 4		unused (always 0)	—	—	—
bit 5		S7 (option)	terminal - CC open	terminal - CC shorted	0020
bit 6		RES	terminal - CC open	terminal - CC shorted	0040
bit 7		ST	terminal - CC open	terminal - CC shorted	0080

Ex. 1) Input terminal monitor example (reading the input terminal status of inverter number "00"):

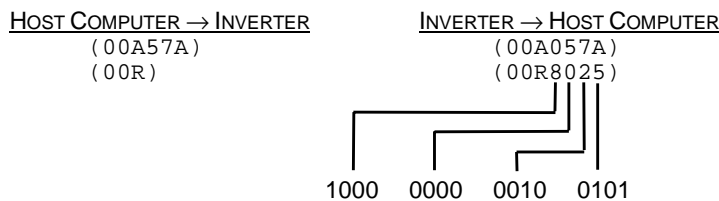

In this example, terminals ST, S4, S1 and F are shorted to CC, and all others are open.

Ex. 2) Example of monitoring only terminals S1 ~ S4 (again from inverter number "00"):

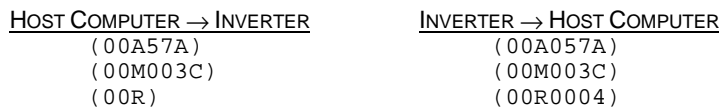

In this example, terminal S1 is shorted to CC, and S2 ~ S4 are open.

TOSHIBA

Output Terminal Status Monitor

Bit Monitor 2	0579H	Output Terminal	0	1	Single-Bit Read Mask
bit 0		unused (always 0)	—	—	—
bit 1		unused (always 0)	—	—	—
bit 2		FAN	OFF	ON	0004
bit 3		FL	FLB-FLC shorted	FLA-FLC shorted	0008
bit 4		MS relay	OFF	ON	0010
bit 5		OUT (option)	OUTB-OUTC shorted	OUTA-OUTC shorted	0020
bit 6		RCH	RCHA-RCHC open	RCHA-RCHC shorted	0040
bit 7		LOW	LOWA-LOWC open	LOWA-LOWC shorted	0080

Inverter Status Monitor

Inverter Status 1 Lower Byte	05B6H	Inverter Status	0	1	Single-Bit Read Mask
bit 0		running (acc/dec)	—	running	0001
bit 1		unused (always 0)	—	—	—
bit 2		forward / reverse	reverse	forward	0004
bit 3		acc/dec #1/#2	acc/dec #1	acc/dec #2	0008
bit 4		for inverter use	—	—	—
bit 5		for inverter use	—	—	—
bit 6		for inverter use	—	—	—
bit 7		jog/normal mode	normal (acc/dec)	jog mode	0080

Inverter Status 1 Upper Byte	05B7H	Inverter Status	0	1	Single-Bit Read Mask
bit 0		feedback ON/OFF	OFF	feedback active	0001
bit 1		DC inject. braking	OFF	DC inject. braking active	0002
bit 2		V/F #1/#2	V/F #1	V/F #2	0004
bit 3		coasting	not coasting	coasting	0008
bit 4		emergency off	not in emergency off	in emergency off	0010
bit 5		for inverter use	—	—	—
bit 6		for inverter use	—	—	—
bit 7		for inverter use	—	—	—

Inverter Status 2	05BBH	Inverter Status	0	1	Single-Bit Read Mask
bit 0		accelerating	not accelerating	accelerating	0001
bit 1		decelerating	not decelerating	decelerating	0002
bit 2		for inverter use	—	—	—
bit 3		retry	not retrying	retrying	0008
bit 4		running (including DC inject. braking)	stopped	running	0010
bit 5		for inverter use	—	—	—
bit 6		for inverter use	—	—	—
bit 7		tripped	not tripped	tripped	0080

Ex) Inverter status monitoring example (reading the status of inverter number "00"):

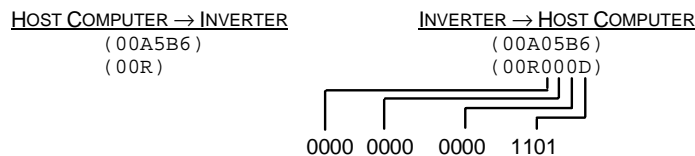

In this example, the inverter is running forward in normal acc/dec mode using acc/dec #2 and V/F #1.

TOSHIBA**Table 1. List of trips (trips registered as past faults)**

LCD Display Message	Data (Hex)	Explanation
NO ERROR	xx00	No error has been recorded since the last inverter reset or trip clear
OVERCURRENT (ACCEL) (PRESS CLEAR)	xx01	Overcurrent during acceleration
OVERCURRENT (DECEL) (PRESS CLEAR)	xx02	Overcurrent during deceleration
OVERCURRENT (RUN) (PRESS CLEAR)	xx03	Overcurrent during constant-speed run
LOAD-END OVERCURRENT (PRESS CLEAR)	xx04	Load-end overcurrent detected at start-up (output terminals, motor wiring etc.)
U-PHASE SHORT CKT (PRESS CLEAR)	xx05	U-phase armature short circuit
V-PHASE SHORT CKT (PRESS CLEAR)	xx06	V-phase armature short circuit
W-PHASE SHORT CKT (PRESS CLEAR)	xx07	W-phase armature short circuit
LOST INPUT PHASE (PRESS CLEAR)	xx08	Lost input phase (option)
LOST OUTPUT PHASE (PRESS CLEAR)	xx09	Lost output phase (option)
OVERVOLTAGE (ACCEL) (PRESS CLEAR)	xx0A	Overvoltage during acceleration
OVERVOLTAGE (DECEL) (PRESS CLEAR)	xx0B	Overvoltage during deceleration
OVERVOLTAGE (RUN) (PRESS CLEAR)	xx0C	Overvoltage during constant-speed run
INVERTER OVERLOAD (PRESS CLEAR)	xx0D	Inverter overload
MOTOR OVERLOAD (PRESS CLEAR)	xx0E	Motor overload
DBR OVERLOAD TRIP (PRESS CLEAR)	xx0F	Dynamic braking resistor overload
OVERHEAT TRIP (PRESS CLEAR)	xx10	Inverter overheat
EMERGENCY OFF (PRESS CLEAR)	xx11	Emergency off
EEPROM WRITE FAILURE (PRESS CLEAR)	xx12	EEPROM failure during write
EEPROM READ FAILURE (PRESS CLEAR)	xx13	EEPROM failure during initial read
—	xx14	Unused
RAM ERROR (PRESS CLEAR)	xx15	RAM error
ROM ERROR (PRESS CLEAR)	xx16	ROM error
CPU ERROR (PRESS CLEAR)	xx17	CPU error

TOSHIBA

LCD Display Message	Data (Hex)	Explanation
COMMUNICATION ERROR (PRESS CLEAR)	××18	RS232C timer time-out
GATE ARRAY FAULT (PRESS CLEAR)	××19	Gate array error
CURRENT DETECT ERROR (PRESS CLEAR)	××1A	Output current detection circuit error
OPTION PCB ERROR (PRESS CLEAR)	××1B	Option PCB error
OPTION ROM ERROR	××1C	Option ROM error
LOW CURRENT TRIP (PRESS CLEAR)	××1D	Low current
UNDERVOLTAGE TRIP (PRESS CLEAR)	××1E	Main circuit undervoltage
—	××1F	Unused
OVERTORQUE TRIP (PRESS CLEAR)	××20	Overtorque
EARTH FAULT (SOFT) (PRESS CLEAR)	××21	Earth fault (software)
EARTH FAULT (HARD) (PRESS CLEAR)	××22	Earth fault (hardware)
OPEN FUSE TRIP (PRESS CLEAR)	××23	Open fuse
DBR OVERCURRENT TRIP (PRESS CLEAR)	××24	Dynamic braking resistor overcurrent
DC OVERCURRENT (ACC) (PRESS CLEAR)	××25	Overcurrent in DC section during acceleration
DC OVERCURRENT (DEC) (PRESS CLEAR)	××26	Overcurrent in DC section during deceleration
DC OVERCURRENT (RUN) (PRESS CLEAR)	××27	Overcurrent in DC section during constant-speed run
AUTO-TUNING ERROR (PRESS CLEAR)	××28	Auto-tuning error
INV TYPEFORM ERROR (PRESS READ/WRITE)	××29	Inverter typeform error

TOSHIBA

Table 2. Trip data configuration (: starting point)

When a trip occurs, the oldest trip becomes the starting point (00H), and the most recent trip is placed at the previous starting point address (refer to Table 1 for trip codes):

04F3H	04F4H	04F5H	04F6H	04F7H	Trip Status
00H	00H	00H	00H	00H	Initial status (no trips)
00H	00H	00H	00H	01H	1 st trip
00H	01H	03H	0BH	01H	4 th trip
0BH	01H	03H	0BH	00H	5 th trip
0BH	01H	03H	00H	13H	6 th trip

Table 3. Pre-alarm status monitor data (bank 0)

05D4H	Function	LCD Display Message	0	1
bit 0 ~ bit 3	unused	—	—	—
bit 4	overload pre-alarm status	OVERLOAD	no pre-alarm	pre-alarm
bit 5	overvoltage pre-alarm status	OVERVOLTAGE	no pre-alarm	pre-alarm
bit 6	overcurrent pre-alarm status	OVERCURRENT	no pre-alarm	pre-alarm
bit 7	overheat pre-alarm status	OVERHEAT	no pre-alarm	pre-alarm

Table 4. Messages (non-trips)

LCD Display Message	Bank	Address	Mask	Data
INVERTER OFF (ST-CC IS OPEN)	0	051B	0008	0008: ST-CC open
CONTROL POWER LOW	0	05B4	0010	0010: control circuit undervoltage
DC BUS UNDERVOLTAGE	0	05B4	0001	0001: main circuit undervoltage
FREQUENCY POINT SETTING ERROR	0	05D4	0002	0002: frequency point setting error alarm

Message monitor example (communicating with inverter number “00”):

HOST COMPUTER → INVERTER

(00B0)
(00A5B4)
(00M0001)
(00R)

INVERTER → HOST COMPUTER

(00B0000)
(00A05B4)
(00M0001)
(00R0001)

In this case, a main circuit undervoltage condition is being indicated.

TOSHIBA

Table 5. Inverter typeform codes

230v Class	
Inverter Model	Typeform Data (Hex)
G3-2010	xx21
G3-2015	xx22
G3-2025	xx23
G3-2035	xx24
G3-2055	xx25
G3-2080	xx26
G3-2110	xx27
G3-2160	xx28
G3-2220	xx29
G3-2270	xx2A
G3-2330	xx2B
G3-2400	xx2C

460v Class	
Inverter Model	Typeform Data (Hex)
G3-4015	xx42
G3-4025	xx43
G3-4035	xx44
G3-4055	xx45
G3-4080	xx46
G3-4110	xx47
G3-4160	xx48
G3-4220	xx49
G3-4270	xx4A
G3-4330	xx4B
G3-4400	xx4C
G3-4500	xx4D
G3-4600	xx4E
G3-4750	xx4F
G3-410K	xx50
G3-412K	xx51
G3-415K	xx52
G3-420K	xx53
G3-425K	xx54
G3-430K	xx55

575v Class	
Inverter Model	Typeform Data (Hex)
G3-6060	xx65
G3-6120	xx67
G3-6160	xx68
G3-6220	xx69
G3-6270	xx6A
G3-6330	xx6B
G3-6400	xx6C
G3-6500	xx6D
G3-6600	xx6E
G3-6750	xx6F
G3-610K	xx70
G3-612K	xx71
G3-615K	xx72
G3-620K	xx73

TOSHIBA

Parameter List

GROUP : FUNDAMENTAL PARAMETERS #1

Function / Title	Bank	Address	Mask	Adjustment Range	Multiplier
MAXIMUM OUTPUT FREQUENCY (*)	0 / 1	03C0	FFFF	0BB8 ~ 9C40 (30.00 ~ 400.00)	0.01
BASE FREQUENCY #1	0 / 1	0428	FFFF	09C4 ~ 9C40 (25.00 ~ 400.00)	0.01
BASE FREQUENCY VOLTAGE SELECT (Note, *)	0 / 1	04BE	0030	0000: Input voltage level (0) 0020: Automatic setting (1) 0030: Stationary setting (2)	—
MAXIMUM OUTPUT VOLTAGE #1	0 / 1	0426	FFFF	0000 ~ 0258 (0 ~ 600)	1
REVERSE OPERATION DISABLE SELECT	0 / 1	04B6	0020	0000: Reverse allowed (0) 0020: Reverse not allowed (1)	—
UPPER LIMIT FREQUENCY	0 / 1	03C2	FFFF	0 ~ Fmax	0.01
LOWER LIMIT FREQUENCY	0 / 1	03C4	FFFF	0 ~ UL, Fmax	0.01
VOLTS PER HERTZ PATTERN (Note, *)	0 / 1	042D	000F	0000: Constant torque (1) 0001: Variable torque (2) 0002: Auto. torque boost (3) 0006: 3 w/ auto. eng. sav. (4) 000A: vector control (5) 000E: 5 w/ auto. eng. sav. (6)	—
1 • 2 VOLTAGE BOOST #1	0 / 1	0424	FFFF	0000 ~ 012C (0.0 ~ 30.0)	0.1
ACCELERATION TIME #1 (Ref. 1)	0 / 1	03C6	FFFF	0001 ~ EA60	0.01 / 0.1
DECELERATION TIME #1	0 / 1	03C8	FFFF	(0.01 ~ 600.00 / 0.1 ~ 6000.0)	0.01 / 0.1
ACC/DEC PATTERN #1 SELECTION	0 / 1	042D	0030	0000: Linear (0) 0010: Self-adjusting (1) 0020: S-Pattern #1 (2) 0030: S-Pattern #2 (3)	—
ACCEL/DECEL PATTERN ADJUST LOW	0 / 1	04C4	00FF	0003 ~ 00FD (0 ~ 50)	(Special)
ACCEL/DECEL PATTERN ADJUST HIGH	0 / 1	04C5	00FF		(Special)

Codes used throughout this parameter list:

(*) : Cannot set while inverter is running.

(Note) : No data checking performed → “Mask” and “Adjustment Range” sections will be shaded.

(Special) : Internal data = (display setting × 5 + 3), converted to hexadecimal.

(Ref. 1) : The adjustment range and multiplier depend on the setting of ACC/DEC TIME UNITS SELECTION in GROUP : UTILITY PARAMETERS as follows:

When ACC/DEC TIME UNITS SELECTION is set for 0.1 sec. units, adjustment range = 0.1 ~ 6000.0, and multiplier = 0.1.

When ACC/DEC TIME UNITS SELECTION is set for 0.01 sec. units, adjustment range = 0.01 ~ 600.00, and multiplier = 0.01.

In addition, if the setting of ACC/DEC TIME UNITS SELECTION is changed after setting the ACC/DEC times, the ACC/DEC times will become 10 times or 0.1 times their former value. Therefore, always reset the ACC/DEC time settings after changing the setting of ACC/DEC TIME UNITS SELECTION.

TOSHIBA**GROUP : FUNDAMENTAL PARAMETERS #2**

Function / Title		Bank	Address	Mask	Adjustment Range	Multiplier
BASE FREQUENCY #2		0 / 1	0432	FFFF	09C4 ~ 9C40 (25.00 ~ 400.00)	0.01
MAXIMUM OUTPUT VOLTAGE #2		0 / 1	0430	FFFF	0000 ~ 0258 (0 ~ 600)	1
VOLTAGE BOOST #2		0 / 1	042E	FFFF	0000 ~ 012C (0.0 ~ 30.0)	0.1
ELECTRONIC THERMAL PROTECT LVL #2		0 / 1	0434	00FF	000A ~ 0064 (10 ~ 100)	1
STALL PROTECTION SELECTION #2		0 / 1	0437	0040	0000: ON (0) 0040: OFF (1)	—
0	STALL PROTECTION LEVEL #2	0 / 1	0435	00FF	000A ~ 00D7 (10 ~ 215)	1
ACCELERATION TIME #2 (Ref. 1)		0 / 1	03CA	FFFF	0001 ~ EA60	0.01 / 0.1
DECELERATION TIME #2		0 / 1	03CC	FFFF	(0.01 ~ 600.00 / 0.1 ~ 6000.0)	
ACC/DEC PATTERN #2 SELECTION		0 / 1	0437	0030	0000: Linear (0) 0010: Self-adjusting (1) 0020: S-Pattern #1 (2) 0030: S-Pattern #2 (3)	—
ACC/DEC #1/#2 SWITCH FREQUENCY		0 / 1	0406	FFFF	0000 ~ Fmax	0.01

<< The following functions are valid only when COMMAND MODE SELECTION in GROUP : UTILITY PARAMETERS is set to 2 (panel input valid) or 4 (local/remote changeover possible). >>

GROUP : PANEL CONTROL PARAMETERS

Function / Title		Bank	Address	Mask	Adjustment Range	Multiplier
DIRECTION SELECTION (FORWARD/REV)		0 / 1	04FA	0004	0000: Reverse (0) 0004: Forward (1)	—
STOP PATTERN SELECTION		0 / 1	045C	0040	0000: Decelerated stop (0) 0040: Coast stop (1)	—
FUNDAMENTAL PARAM SWITCHING		0 / 1	04FB	0004	0000: V/F #1 (1) 0004: V/F #2 (2)	—
ACCEL/DECCEL #1/#2 SELECTION		0 / 1	04FA	0008	0000: Acc / dec #1 (1) 0008: Acc / dec #2 (2)	—
PANEL RESET SELECTION		0 / 1	045C	0030	0000: All possible (0) 0010: overload only (1) 0020: overload, overcurrent only (2)	—
PANEL FEEDBACK CONTROL (Note 1)		0 / 1	04FB	0001	0000: Feedback valid (0) 0001: Feedback invalid (1)	—

(Note 1): This parameter only selects whether or not feedback control is valid when feedback control is selected. In order to use feedback control, parameter FEEDBACK CONTROL SELECTION in GROUP : FEEDBACK CONTROL PARAMETERS must still be set.

TOSHIBA

GROUP : TERMINAL SELECTION PARAMETERS

Function / Title		Bank	Address	Mask	Adjustment Range	Multiplier
INPUT TERMINAL SELECTION		0 / 1	04BB	0001	0000: Standard functions (0) 0001: Individual selection (1)	—
1	"R" INPUT TERMINAL FUNCTION	0 / 1	046C	FFFF	0000 ~ FFFF (0 ~ 54) Refer to Table 6 (Note)	—
	"S1" INPUT TERMINAL FUNCTION	0 / 1	046E	FFFF		
	"S2" INPUT TERMINAL FUNCTION	0 / 1	0470	FFFF		
	"S3" INPUT TERMINAL FUNCTION	0 / 1	0472	FFFF		
	"S4" INPUT TERMINAL FUNCTION	0 / 1	0474	FFFF		
	"F" INPUT TERMINAL FUNCTION	0 / 1	0476	FFFF		
	"RES" INPUT TERMINAL FUNCTION	0 / 1	0478	FFFF		
	"ST" INPUT TERMINAL FUNCTION	0 / 1	047A	FFFF		
	"S5" INPUT TERMINAL FUNCTION	0 / 1	047C	FFFF		
	"S6" INPUT TERMINAL FUNCTION	0 / 1	047E	FFFF		
	"S7" INPUT TERMINAL FUNCTION	0 / 1	0480	FFFF		
	POTENTIAL TERMINAL FUNCTION	0 / 1	0482	FFFF		
R,S1-S7 TERMINAL RESPONSE TIME		0 / 1	0462	00FF	0001 ~ 0064 (1 ~ 100)	1
F INPUT TERMINAL RESPONSE TIME		0 / 1	0463	00FF	0001 ~ 0064 (1 ~ 100)	1
RES INPUT TERMINAL RESPONSE TIME		0 / 1	0464	00FF	0001 ~ 0064 (1 ~ 100)	1
ST INPUT TERMINAL RESPONSE TIME		0 / 1	0465	00FF	0001 ~ 0064 (1 ~ 100)	1
"RCH" CONTACTS FUNCTION		0 / 1	0490	FFFF	0 ~ FFFF (0 ~ 63) See Table 7	—
"RCH" CONTACTS DELAY TIME		0 / 1	0492	00FF	0001 ~ 0064 (1 ~ 100)	—
"RCH" CONTACTS HOLD TIME (Note)		0 / 1	0493	00FF	0001 ~ 0064 (1 ~ 100)	
"LOW" CONTACTS FUNCTION		0 / 1	048C	FFFF	0 ~ FFFF (0 ~ 63) See Table 7	
"LOW" CONTACTS DELAY TIME		0 / 1	048E	00FF	0001 ~ 0064 (1 ~ 100)	—
"LOW" CONTACTS HOLD TIME (Note)		0 / 1	048F	00FF	0001 ~ 0064 (1 ~ 100)	
"FL" CONTACTS FUNCTION		0 / 1	0494	FFFF	0 ~ FFFF (0 ~ 63) See Table 7	
"FL" CONTACTS DELAY TIME		0 / 1	0496	00FF	0001 ~ 0064 (1 ~ 100)	—
"FL" CONTACTS HOLD TIME (Note)		0 / 1	0497	00FF	0001 ~ 0064 (1 ~ 100)	
"OUT" CONTACTS FUNCTION		0 / 1	0498	FFFF	0 ~ FFFF (0 ~ 63) See Table 7	
"OUT" CONTACTS DELAY TIME		0 / 1	049A	00FF	0001 ~ 0064 (1 ~ 100)	—
"OUT" CONTACTS HOLD TIME (Note)		0 / 1	049B	00FF	0001 ~ 0064 (1 ~ 100)	
LOW SPEED SIGNAL OUTPUT FREQ		0 / 1	03FE	FFFF	0 ~ Fmax	
ACC/DEC COMPLETE DETECT BAND		0 / 1	0400	FFFF	0 ~ Fmax	0.01
SPEED REACH MAXIMUM FREQUENCY		0 / 1	0404	FFFF	0 ~ Fmax	0.01
SPEED REACH MINIMUM FREQUENCY		0 / 1	0402	FFFF	0 ~ Fmax	0.01
COMMERCIAL POWER/INV SWITCHING OUTPUT		0 / 1	04C1	00C0	0000: OFF (0) 0040: Auto. switch on trip (1) 0080: Switch at COMMERCIAL POWER/INV SWITCH FREQ (2) 00C0: Both (1) and (2) (3)	—
2 • 3	COMMERCIAL POWER/INV SWITCH FREQ	0 / 1	041C	FFFF	0 ~ Fmax	0.01
"FP" OUTPUT TERMINAL PULSE FREQUENCY		0 / 1	04C0	0003	0000: 48f (0) 0001: 96f (1) 0002: 360f (2)	—
RR INPUT SPECIAL FUNCTION SELECT (Note)		0 / 1	04B8	00E0	0000: Standard (0) 0040: Fmax (1) 0080: TACC/TDEC mult. (2) 00C0: VB mult. factor (3) 0020: CL mult. factor (4)	—

TOSHIBA**Table 6. Input terminal selections**

Setting Value	Data (Hex)	Function	Setting Value	Data (Hex)	Function
0	10C8	R (reverse run)	28	04AF	Binary bit #6
1	011C	SS1 (preset speed selection)	29	08AF	Binary bit #7
2	021C	SS2 (preset speed selection)	30	10AF	Binary bit #8
3	041C	SS3 (preset speed selection)	31	20AF	Binary bit #9
4	081C	SS4 (preset speed selection)	32	40AF	Binary bit #10
5	20C8	F (forward run)	33	04CE	No effect
6	201B	RES (fault reset)	34	01C7	UP/DOWN frequency setting (UP)
7	C0C9	ST (gate ON/OFF)	35	02C7	UP/DOWN frequency setting (DOWN)
8	0CC8	JOG selection	36	04C7	UP/DOWN frequency clear
9	081A	Acc/dec #1/#2 selection	37	08C7	PUSH-type RUN key
10	101B	Emergency off	38	10C7	PUSH-type STOP key
11	021B	DC injection braking ON/OFF	39	02B9	No effect
12	041B	Fundamental parameter switching (V/F #2)	40	C0C8	Forward/reverse run selection
13	011B	Feedback control ON/OFF	41	20C7	RUN
14	10CE	Pattern run selection #1	42	30C9	Binary data write
15	20CE	Pattern run selection #2	43	0198	[LOCAL/REMOTE] key
16	40CE	Pattern run selection #3	44	0298	[MON] key
17	80CE	Pattern run selection #4	45	0498	[PRG] key
18	02CE	Pattern run continue signal	46	0898	[UP] (▲) key
19	01CE	Pattern run step trigger signal	47	1098	[DOWN] (▼) key
20	0AC9	JOG forward run	48	2098	[READ/WRITE] key
21	06C9	JOG reverse run	49	4098	[RUN] key
22	10AE	Binary bit #0	50	8098	[STOP/CLEAR] key
23	20AE	Binary bit #1	51	08CE	Commercial power / inverter switching signal
24	40AE	Binary bit #2	52	40C7	Reserved for option use
25	80AE	Binary bit #3	53	10CB	RR frequency switching input
26	01AF	Binary bit #4	54	20CB	IV frequency switching input
27	02AF	Binary bit #5			

(Note): In order for binary bit #0 ~ #10 (setting values 22 ~ 32) and UP/DOWN frequency setting (setting values 34 & 35) inputs to be valid, parameter FREQUENCY PRIORITY SELECTION #1 or FREQUENCY PRIORITY SELECTION #2 in GROUP:FREQUENCY SETTING PARAMETERS must be set to 5 (BIN (binary setting or UP/DOWN setting)).

TOSHIBA**Table 7. Output terminal selections (RCH, LOW, FL, OUT relay contacts)**

Setting Value	Data (Hex)	Function	Setting Value	Data (Hex)	Function
0	0000	Lower limit frequency	32	C5B7	Executing emergency off
1	0100	/Lower limit frequency	33	CDB7	/Executing emergency off
2	0200	Upper limit frequency	34	B5BB	Executing retry
3	0300	/Upper limit frequency	35	BDBB	/Executing retry
4	0400	Low speed signal	36	D5CF	Pattern run switching output
5	0500	/Low speed signal	37	DDCF	/Pattern run switching output
6	0600	Accel/decel complete	38	D5D8	PID deviation limit
7	0700	/Accel/decel complete	39	DDD8	/PID deviation limit
8	0800	Selected speed reach signal	40	C5BB	Run/stop
9	0900	/Selected speed reach signal	41	CDBB	/Run/stop
10	0A00	Fault	42	1400	Severe fault (armature short, load-end short, open phase, output error, earth fault)
11	0B00	/Fault	43	1500	/Severe fault (armature short, load-end short, open phase, output error, earth fault)
12	0C00	Fault other than earth fault or load-end overcurrent	44	1600	Non-severe fault (overload, overcurrent, overvoltage)
13	0D00	/Fault other than earth fault or load-end overcurrent	45	1700	/Non-severe fault (overload, overcurrent, overvoltage)
14	95B5	Overcurrent pre-alarm	46	E5D8	Commercial power / inverter switching output #1
15	9DB5	/Overcurrent pre-alarm	47	EDD8	/Commercial power / inverter switching output #1
16	85C5	Inverter overload pre-alarm	48	F5D8	Commercial power / inverter switching output #2
17	8DC5	/Inverter overload pre-alarm	49	FDD8	/Commercial power / inverter switching output #2
18	95C5	Motor overload pre-alarm	50	85C0	Fan ON/OFF
19	9DC5	/Motor overload pre-alarm	51	8DC0	/Fan ON/OFF
20	D5C5	Overheat pre-alarm	52	F5B6	Executing JOG
21	DDC5	/Overheat pre-alarm	53	FDB6	/Executing JOG
22	A5B4	Overvoltage pre-alarm	54	1800	Local/remote operation
23	ADB4	/Overvoltage pre-alarm	55	1900	/Local/remote operation
24	E5B4	Undervoltage alarm	56	A5D1	Cumulative timer alarm
25	EDB4	/Undervoltage alarm	57	ADD1	/Cumulative timer alarm
26	85B5	Undercurrent alarm	58	1A00	Communication error alarm
27	8DB5	/Undercurrent alarm	59	1B00	/Communication error alarm
28	85D1	Overtorque alarm	60	A5B6	F/R
29	8DD1	/Overtorque alarm	61	ADB6	/F/R
30	E5BB	Braking resistor OL pre-alarm	62	1E00	Run preparation complete

TOSHIBA

31	EDBB	/Braking resistor OL pre- alarm	63	1F00	/Run preparation complete
----	------	------------------------------------	----	------	---------------------------

TOSHIBA**GROUP : SPECIAL CONTROL PARAMETERS**

Function / Title		Bank	Address	Mask	Adjustment Range	Multiplier
START-UP FREQUENCY		0 / 1	03F8	FFFF	0000 ~ 03E8 (0.00 ~ 10.00)	0.01
END FREQUENCY		0 / 1	03FA	FFFF	0000 ~ 0BB8 (0.00 ~ 30.00)	0.01
RUN FREQUENCY		0 / 1	0408	FFFF	0000 ~ Fmax	0.01
RUN FREQUENCY HYSTERESIS		0 / 1	040A	FFFF	0000 ~ 0BB8 (0.00 ~ 30.00)	0.01
ENABLE JUMP FREQUENCIES		0 / 1	04BB	0080	0000: Function OFF (0) 0080: Function ON (1)	—
1	JUMP FREQUENCY #1	0 / 1	03EE	FFFF	0000 ~ Fmax	0.01
	JUMP FREQUENCY #1 BANDWIDTH	0 / 1	03EC	FFFF	0000 ~ 0BB8 (0.00 ~ 30.00)	0.01
	JUMP FREQUENCY #2	0 / 1	03F2	FFFF	0000 ~ Fmax	0.01
	JUMP FREQUENCY #2 BANDWIDTH	0 / 1	03F0	FFFF	0000 ~ 0BB8 (0.00 ~ 30.00)	0.01
	JUMP FREQUENCY #3	0 / 1	03F6	FFFF	0000 ~ Fmax	0.01
	JUMP FREQUENCY #3 BANDWIDTH	0 / 1	03F4	FFFF	0000 ~ 0BB8 (0.00 ~ 30.00)	0.01
PWM CARRIER FREQUENCY (#)		0 / 1	0439	00FF	0005 ~ 0064 (0.5 ~ 10.0)	0.1

(#) : Adjustment range depends on inverter rating.

TOSHIBA**GROUP:FREQUENCY SETTING PARAMETERS**

Function / Title		Bank	Address	Mask	Adjustment Range	Multiplier
FREQUENCY PRIORITY SELECTION #1		0 / 1	04BA	0007	0001: RR (1) 0002: IV (2) 0003: RX (3) 0004: PG (4) 0005: BIN (5)	—
FREQUENCY PRIORITY SELECTION #2		0 / 1	04BA	0038	0008: RR (1) 0010: IV (2) 0018: RX (3) 0020: PG (4) 0028: BIN (5)	—
ANALOG INPUT FILTER		0 / 1	04BC	0003	0000: No filter (0) 0001: Small filter (1) 0002: Medium filter (2) 0003: Large filter (3)	—
RR TERMINAL STANDARD OR ADJUSTABLE		0 / 1	04B8	0002	0000: Standard (0) 0002: Adjustable (1)	—
1	RR REFERENCE SETTING POINT #1	0 / 1	0449	00FF	0000 ~ 0064 (0 ~ 100)	1
	RR REF POINT #1 FREQUENCY	0 / 1	03DA	FFFF	0000 ~ Fmax	0.01
	RR REFERENCE SETTING POINT #2	0 / 1	044A	00FF	0000 ~ 0064 (0 ~ 100)	1
	RR REF POINT #2 FREQUENCY	0 / 1	03DC	FFFF	0000 ~ Fmax	0.01
IV TERMINAL STANDARD OR ADJUSTABLE		0 / 1	04B8	0004	0000: Standard (0) 0004: Adjustable (1)	—
1	IV REFERENCE SETTING POINT #1	0 / 1	044B	00FF	0000 ~ 0064 (0 ~ 100)	1
	IV REF POINT #1 FREQUENCY	0 / 1	03DE	FFFF	0000 ~ Fmax	0.01
	IV REFERENCE SETTING POINT #2	0 / 1	044C	00FF	0000 ~ 0064 (0 ~ 100)	1
	IV REF POINT #2 FREQUENCY	0 / 1	03E0	FFFF	0000 ~ Fmax	0.01
RX TERMINAL STANDARD OR ADJUSTABLE		0 / 1	04B8	0008	0000: Standard (0) 0008: Adjustable (1)	—
1	RX REFERENCE SETTING POINT #1	0 / 1	044D	00FF	009C ~ 00FF, 0000 ~ 0064 (-100 ~ -1, 0 ~ 100)	1
	RX REF POINT #1 FREQUENCY	0 / 1	03E2	FFFF	-Fmax ~ Fmax	0.02
	RX REFERENCE SETTING POINT #2	0 / 1	044E	00FF	009C ~ 00FF, 0000 ~ 0064 (-100 ~ -1, 0 ~ 100)	1
	RX REF POINT #2 FREQUENCY	0 / 1	03E4	FFFF	-Fmax ~ Fmax	0.02
PG TERMINAL STANDARD OR ADJUSTABLE		0 / 1	04B8	0010	0000: Standard (0) 0010: Adjustable (1)	—
1	PG REFERENCE SETTING POINT #1	0 / 1	044F	00FF	009C ~ 00FF, 0000 ~ 0064 (-100 ~ -1, 0 ~ 100)	1
	PG REF POINT #1 FREQUENCY	0 / 1	03E6	FFFF	-Fmax ~ Fmax	0.02
	PG REFERENCE SETTING POINT #2	0 / 1	0450	00FF	009C ~ 00FF, 0000 ~ 0064 (-100 ~ -1, 0 ~ 100)	1
	PG REF POINT #2 FREQUENCY	0 / 1	03E8	FFFF	-Fmax ~ Fmax	0.02
BINARY INPUT STD OR ADJUSTABLE		0 / 1	04B8	0001	0000: Standard (0) 0001: Adjustable (1)	—
1	BINARY REF SETTING POINT #1	0 / 1	0447	00FF	0000 ~ 0064 (0 ~ 100)	1
	BINARY REF POINT #1 FREQUENCY	0 / 1	03D6	FFFF	-Fmax ~ Fmax	0.02
	BINARY REF SETTING POINT #2	0 / 1	0448	00FF	0000 ~ 0064 (0 ~ 100)	1
	BINARY REF POINT #2 FREQUENCY	0 / 1	03D8	FFFF	-Fmax ~ Fmax	0.02
JOG RUN FREQUENCY		0 / 1	03EA	FFFF	0000 ~ 07D0 (0.00 ~ 20.00)	0.01
Other than 0	JOG STOP METHOD	0 / 1	04B6	00C0	0000: Decelerated stop (0) 0040: Coast stop (1) 0080: DC injection stop (2)	—
PRESET SPEED SELECTION		0 / 1	04A6	000F	0000 ~ 000F (0 ~ 15)	1

TOSHIBA

Function / Title		Bank	Address	Mask	Adjustment Range	Multiplier
Other than 0	PRESET SPEED MODE ACTIVATION	0 / 1	04BB	0004	0000: Deactivated (0) 0004: Activated (1)	—
	PRESET SPEED #1 FREQUENCY	1	0528	FFFF	LL ~ UL	0.01
	PRESET SPEED #1 OPERATING MODE	1	052A	040C	0004 (0) 0000 (1) 000C (2) 0008 (3) (Note 1) 0404 (4) 0400 (5) 040C (6) 0408 (7)	1
2 or higher	PRESET SPEED #2 FREQUENCY	1	0530	FFFF	LL ~ UL	0.01
	PRESET SPEED #2 OPERATING MODE	1	0532	040C	(Note 2)	1
3 or higher	PRESET SPEED #3 FREQUENCY	1	0538	FFFF	LL ~ UL	0.01
	PRESET SPEED #3 OPERATING MODE	1	053A	040C	(Note 2)	1
4 or higher	PRESET SPEED #4 FREQUENCY	1	0540	FFFF	LL ~ UL	0.01
	PRESET SPEED #4 OPERATING MODE	1	0542	040C	(Note 2)	1
5 or higher	PRESET SPEED #5 FREQUENCY	1	0548	FFFF	LL ~ UL	0.01
	PRESET SPEED #5 OPERATING MODE	1	054A	040C	(Note 2)	1
6 or higher	PRESET SPEED #6 FREQUENCY	1	0550	FFFF	LL ~ UL	0.01
	PRESET SPEED #6 OPERATING MODE	1	0552	040C	(Note 2)	1
7 or higher	PRESET SPEED #7 FREQUENCY	1	0558	FFFF	LL ~ UL	0.01
	PRESET SPEED #7 OPERATING MODE	1	055A	040C	(Note 2)	1
8 or higher	PRESET SPEED #8 FREQUENCY	1	0560	FFFF	LL ~ UL	0.01
	PRESET SPEED #8 OPERATING MODE	1	0562	040C	(Note 2)	1
9 or higher	PRESET SPEED #9 FREQUENCY	1	0568	FFFF	LL ~ UL	0.01
	PRESET SPEED #9 OPERATING MODE	1	056A	040C	(Note 2)	1
10 or higher	PRESET SPEED #10 FREQUENCY	1	0570	FFFF	LL ~ UL	0.01
	PRESET SPEED #10 OPERATING MODE	1	0572	040C	(Note 2)	1
11 or higher	PRESET SPEED #11 FREQUENCY	1	0578	FFFF	LL ~ UL	0.01
	PRESET SPEED #11 OPERATING MODE	1	057A	040C	(Note 2)	1
12 or higher	PRESET SPEED #12 FREQUENCY	1	0580	FFFF	LL ~ UL	0.01
	PRESET SPEED #12 OPERATING MODE	1	0582	040C	(Note 2)	1
13 or higher	PRESET SPEED #13 FREQUENCY	1	0588	FFFF	LL ~ UL	0.01
	PRESET SPEED #13 OPERATING MODE	1	058A	040C	(Note 2)	1
14 or higher	PRESET SPEED #14 FREQUENCY	1	0590	FFFF	LL ~ UL	0.01
	PRESET SPEED #14 OPERATING MODE	1	0592	040C	(Note 2)	1
15	PRESET SPEED #15 FREQUENCY	1	0598	FFFF	LL ~ UL	0.01
	PRESET SPEED #15 OPERATING MODE	1	059A	040C	(Note 2)	1

- Caution!**
- Frequency parameters RX REF POINT #1 FREQUENCY ~ BINARY REF POINT #2 FREQUENCY use signed data (data values larger than 7FFFH are negative). If internal data is 8000H or larger, the actual setting can be obtained by using the conversion formula: **actual setting = - [FFFFH - (internal data) + 1]**. In addition, due to the fact that the multiplier is 0.02, use $F_{max} \div 2$ (converted to hexadecimal) for adjustment limits ($-F_{max} \div 2 \sim F_{max} \div 2$ corresponds to $-F_{max} \sim F_{max}$).
 - Setting point parameters RX REFERENCE SETTING POINT #1 ~ PG REFERENCE SETTING POINT #2 use signed data (data values from 0080H to 00FFH are negative). If internal data is between 0080H and 00FFH, the actual setting can be obtained by using the conversion formula: **actual setting = - [00FFH - (internal data) + 1]**.

(Note 1): Use caution with these parameters, as the internal data values do not follow the same setting format as those set from the operating panel. A look-up table, etc., can be used in the application program to reference these values properly.

(Note 2): Adjustment range is the same as PRESET SPEED #1 OPERATING MODE.

TOSHIBA**GROUP : PROTECTION FUNCTION PARAMETERS**

Function / Title		Bank	Address	Mask	Adjustment Range	Multiplier
DYNAMIC BRAKING SELECTION (Note)		0 / 1	04BD	0003	0000: no dynam. braking (0) 0001: with dynamic braking, no DBR OL trip (1) 0003: with dynamic braking and DBR OL trip (2)	—
2	BRAKING RESISTOR VALUE	0 / 1	0416	FFFF	000A ~ 2710 (1.0 ~ 1000)	0.1
	BRAKING RESISTOR POWER RATING	0 / 1	0418	FFFF	0001 ~ EA60 (0.01 ~ 600.00)	0.01
OVERVOLTAGE STALL PROTECTION		0 / 1	04BD	0004	0000: ON (0) 0004: OFF (1)	—
DC INJECTION START FREQUENCY		0 / 1	03FC	FFFF	0000 ~ 2EE0 (0.00 ~ 120.00)	0.01
Other than 0	DC INJECTION CURRENT MAGNITUDE	0 / 1	043A	00FF	0000 ~ 0064 (0 ~ 100)	1
	DC INJECTION TIME	0 / 1	043B	00FF	0000 ~ 0064 (0.0 ~ 10.0)	0.1
FWD/REV DC INJECTION PRIORITY CTRL		0 / 1	04BC	0040	0000: OFF (0) 0040: ON (1)	—
MOTOR SHAFT STATIONARY CTRL		0 / 1	04BC	0080	0000: OFF (0) 0080: ON (1)	—
EMERGENCY OFF MODE SELECTION		0 / 1	04BC	0030	0000: Coast stop (0) 0010: Decelerated stop (1) 0020: DC injection stop (2)	—
2	EMERGENCY OFF DC INJECTION TIME	0 / 1	043D	00FF	0000 ~ 0064 (0.0 ~ 10.0)	0.1
NUMBER OF RETRY ATTEMPTS		0 / 1	043F	00FF	0000 ~ 000A (0 ~ 10)	1
Other than 0	TIME BETWEEN RETRY ATTEMPTS	0 / 1	0440	00FF	0000 ~ 0064 (0.0 ~ 10.0)	0.1
REGENERATION POWER RIDE-THROUGH		0 / 1	04BD	0008	0000: OFF (0) 0008: ON (1)	—
1	REGENERATION RIDE-THROUGH TIME	0 / 1	0446	00FF	0000 ~ 00FA (0.0 ~ 25.0)	0.1
AUTO-RESTART (MOTOR SPEED SEARCH)		0 / 1	04B6	0018	0000: OFF (0) 0008: On power failure (1) 0010: On ST make/break (2) 0018: Both (1) and (2) (3)	—
ELECTRONIC THERMAL PROTECT LVL #1		0 / 1	042A	00FF	000A ~ 0064 (10 ~ 100)	1
OVERLOAD REDUCTION START FREQ		0 / 1	0410	FFFF	0000 ~ 0BB8 (0.00 ~ 30.00)	0.01
MOTOR 150% OVERLOAD TIME LIMIT		0 / 1	0444	00FF	0001 ~ 00F0 (10 ~ 2400)	10
OVERLOAD SELECTION		0 / 1	04BD	0030	0000: with motor overload trip, w/o soft-stall (0) 0010: with motor overload trip and soft-stall (1) 0020: w/o soft-stall or motor overload trip (2) 0030: with soft-stall, w/o motor overload trip (3)	—
STALL PROTECTION ENABLE		0 / 1	042D	0040	0000: ON (0) 0040: OFF (1)	—
0	STALL PROTECTION CURRENT LEVEL	0 / 1	042B	00FF	000A ~ 00D7 (10 ~ 215)	1
UNDERVOLTAGE TRIP SELECTION		0 / 1	04BD	0080	0000: Trip disabled (0) 0080: Trip (during run) (1)	—
UNDERVOLTAGE DETECT TIME		0 / 1	0414	FFFF	0000 ~ 03E8 (0.00 ~ 10.00)	0.01
LOW CURRENT DETECT SELECTION		0 / 1	04BC	0008	0000: Trip disabled (0) 0008: Trip on detection (1)	—
LOW CURRENT DETECT LEVEL		0 / 1	0441	00FF	0000 ~ 0064 (0 ~ 100)	1
LOW CURRENT DETECTION TIME		0 / 1	0442	00FF	0000 ~ 00FF (0 ~ 255)	1

TOSHIBA

Function / Title	Bank	Address	Mask	Adjustment Range	Multiplier
OUTPUT SHORT-CIRCUIT DETECTION SELECT	0 / 1	04BE	0003	0000: Standard motor (0) 0001: High-speed motor (1) 0002: Positioning use (standard motor) (2) 0003: Positioning use (high-speed motor) (3)	—
OVERTORQUE TRIP SELECTION	0 / 1	04BE	0040	0000: Trip disabled (0) 0040: Trip enabled (1)	—
OVERTORQUE TRIP LEVEL	0 / 1	0443	00FF	0000 ~ 00C8 (0 ~ 200)	1
FAULT TRIP EEPROM SAVE ENABLE	0 / 1	04B6	0002	0000: Data cleared when powered OFF (0) 0002: Data retained when powered OFF (1)	—
COOLING FAN CONTROL SELECTION	0 / 1	04BE	0004	0000: Automatic (temperature detection) (0) 0004: Always ON (1)	—
CUMULATIVE RUN TIMER ALARM SETTING	0 / 1	0422	FFFF	0000 ~ C34B (0.00 ~ 999.90)	0.02

TOSHIBA**GROUP: PATTERN RUN CONTROL PARAMETERS**

Function / Title		Bank	Address	Mask	Adjustment Range	Multiplier
PATTERN RUN SELECTION		0 / 1	04A7	0008	0000: OFF (0) 0008: ON (1)	—
1	PATTERN RUN CONTINUE MODE	0 / 1	04A7	0001	0000: reset on stop (0) 0001: switch when done (1)	—
	PATTERN GROUP #1 SPEED #0	1	0500	00FF	0000: Skip (0)	1
	PATTERN GROUP #1 SPEED #1	1	0501	00FF	0001 ~ 000F: Speeds 1 ~ 15	
	PATTERN GROUP #1 SPEED #2	1	0502	00FF		
	PATTERN GROUP #1 SPEED #3	1	0503	00FF		
	PATTERN GROUP #1 SPEED #4	1	0504	00FF		
	PATTERN GROUP #1 SPEED #5	1	0505	00FF		
	PATTERN GROUP #1 SPEED #6	1	0506	00FF		
	PATTERN GROUP #1 SPEED #7	1	0507	00FF		
	PATTERN GROUP #1 NUMBER OF CYCLES	0 / 1	049E	00FF		0001 ~ 00FF: 1 ~ 255
	PATTERN GROUP #2 SPEED #0	1	0508	00FF	0000: Skip (0)	1
	PATTERN GROUP #2 SPEED #1	1	0509	00FF	0001 ~ 000F: Speeds 1 ~ 15	
	PATTERN GROUP #2 SPEED #2	1	050A	00FF		
	PATTERN GROUP #2 SPEED #3	1	050B	00FF		
	PATTERN GROUP #2 SPEED #4	1	050C	00FF		
	PATTERN GROUP #2 SPEED #5	1	050D	00FF		
	PATTERN GROUP #2 SPEED #6	1	050E	00FF		
	PATTERN GROUP #2 SPEED #7	1	050F	00FF		
	PATTERN GROUP #2 NUMBER OF CYCLES	0 / 1	04A0	00FF		0001 ~ 00FF: 1 ~ 255
	PATTERN GROUP #3 SPEED #0	1	0510	00FF	0000: Skip (0)	1
	PATTERN GROUP #3 SPEED #1	1	0511	00FF	0001 ~ 000F: Speeds 1 ~ 15	
	PATTERN GROUP #3 SPEED #2	1	0512	00FF		
	PATTERN GROUP #3 SPEED #3	1	0513	00FF		
	PATTERN GROUP #3 SPEED #4	1	0514	00FF		
	PATTERN GROUP #3 SPEED #5	1	0515	00FF		
	PATTERN GROUP #3 SPEED #6	1	0516	00FF		
	PATTERN GROUP #3 SPEED #7	1	0517	00FF		
	PATTERN GROUP #3 NUMBER OF CYCLES	0 / 1	04A2	00FF		0001 ~ 00FF: 1 ~ 255
PATTERN GROUP #4 SPEED #0	1	0518	00FF	0000: Skip (0)	1	
PATTERN GROUP #4 SPEED #1	1	0519	00FF	0001 ~ 000F: Speeds 1 ~ 15		
PATTERN GROUP #4 SPEED #2	1	051A	00FF			
PATTERN GROUP #4 SPEED #3	1	051B	00FF			
PATTERN GROUP #4 SPEED #4	1	051C	00FF			
PATTERN GROUP #4 SPEED #5	1	051D	00FF			
PATTERN GROUP #4 SPEED #6	1	051E	00FF			
PATTERN GROUP #4 SPEED #7	1	051F	00FF			
PATTERN GROUP #4 NUMBER OF CYCLES	0 / 1	04A4	00FF		0001 ~ 00FF: 1 ~ 255	1
SPEED #1 CONTINUE MODE	1	052E	00FF	0000: Count in seconds from time of activation (0) 0001: Count in minutes from time of activation (1) 0002: Count in seconds from speed reach (2) 0003: Count in minutes from speed reach (3) 0004: Non-stop (continue until STOP command) (4) 0005: Continue until next step command (5)	—	
Less than 4	SPEED #1 DRIVE TIME	1	052C	FFFF	0000 ~ 1F40 (0 ~ 8000)	1

TOSHIBA

Function / Title		Bank	Address	Mask	Adjustment Range	Multiplier
SPEED #2 CONTINUE MODE		1	0536	00FF	Same as SPEED #1 CONTINUE MODE	—
Less than 4	SPEED #2 DRIVE TIME	1	0534	FFFF	0000 ~ 1F40 (0 ~ 8000)	1
SPEED #3 CONTINUE MODE		1	053E	00FF	Same as SPEED #1 CONTINUE MODE	—
Less than 4	SPEED #3 DRIVE TIME	1	053C	FFFF	0000 ~ 1F40 (0 ~ 8000)	1
SPEED #4 CONTINUE MODE		1	0546	00FF	Same as SPEED #1 CONTINUE MODE	—
Less than 4	SPEED #4 DRIVE TIME	1	0544	FFFF	0000 ~ 1F40 (0 ~ 8000)	1
SPEED #5 CONTINUE MODE		1	054E	00FF	Same as SPEED #1 CONTINUE MODE	—
Less than 4	SPEED #5 DRIVE TIME	1	054C	FFFF	0000 ~ 1F40 (0 ~ 8000)	1
SPEED #6 CONTINUE MODE		1	0556	00FF	Same as SPEED #1 CONTINUE MODE	—
Less than 4	SPEED #6 DRIVE TIME	1	0554	FFFF	0000 ~ 1F40 (0 ~ 8000)	1
SPEED #7 CONTINUE MODE		1	055E	00FF	Same as SPEED #1 CONTINUE MODE	—
Less than 4	SPEED #7 DRIVE TIME	1	055C	FFFF	0000 ~ 1F40 (0 ~ 8000)	1
SPEED #8 CONTINUE MODE		1	0566	00FF	Same as SPEED #1 CONTINUE MODE	—
Less than 4	SPEED #8 DRIVE TIME	1	0564	FFFF	0000 ~ 1F40 (0 ~ 8000)	1
SPEED #9 CONTINUE MODE		1	056E	00FF	Same as SPEED #1 CONTINUE MODE	—
Less than 4	SPEED #9 DRIVE TIME	1	056C	FFFF	0000 ~ 1F40 (0 ~ 8000)	1
SPEED #10 CONTINUE MODE		1	0576	00FF	Same as SPEED #1 CONTINUE MODE	—
Less than 4	SPEED #10 DRIVE TIME	1	0574	FFFF	0000 ~ 1F40 (0 ~ 8000)	1
SPEED #11 CONTINUE MODE		1	057E	00FF	Same as SPEED #1 CONTINUE MODE	—
Less than 4	SPEED #11 DRIVE TIME	1	057C	FFFF	0000 ~ 1F40 (0 ~ 8000)	1
SPEED #12 CONTINUE MODE		1	0586	00FF	Same as SPEED #1 CONTINUE MODE	—
Less than 4	SPEED #12 DRIVE TIME	1	0584	FFFF	0000 ~ 1F40 (0 ~ 8000)	1
SPEED #13 CONTINUE MODE		1	058E	00FF	Same as SPEED #1 CONTINUE MODE	—
Less than 4	SPEED #13 DRIVE TIME	1	058C	FFFF	0000 ~ 1F40 (0 ~ 8000)	1
SPEED #14 CONTINUE MODE		1	0596	00FF	Same as SPEED #1 CONTINUE MODE	—
Less than 4	SPEED #14 DRIVE TIME	1	0594	FFFF	0000 ~ 1F40 (0 ~ 8000)	1
SPEED #15 CONTINUE MODE		1	059E	00FF	Same as SPEED #1 CONTINUE MODE	—
Less than 4	SPEED #15 DRIVE TIME	1	059C	FFFF	0000 ~ 1F40 (0 ~ 8000)	1

TOSHIBA**GROUP:FEEDBACK CONTROL PARAMETERS**

Function / Title		Bank	Address	Mask	Adjustment Range	Multiplier
FEEDBACK CONTROL SELECTION		0 / 1	04B9	0060	0020: No feedback (0) 0040: PID control (1) 0060: Speed feedback (2)	—
1•2	FEEDBACK INPUT SIGNAL SELECTION	0 / 1	04B9	001C	0004: RR input (1) 0008: IV input (2) 000C: RX input (3) 0010: PG feedback (4) 0014: RS232C input (5) 0018: Communication/12-bit binary option board (6) 001C: BIN input (7)	—
	PROPORTIONAL GAIN	0 / 1	04A8	00FF	0001 ~ 00FF (0.01 ~ 2.55)	0.01
	INTEGRAL GAIN	0 / 1	04AA	FFFF	0001 ~ 8CA0 (0.01 ~ 360.00)	0.01
	ANTI-HUNTING GAIN	0 / 1	04AC	00FF	0000 ~ 00FF (0.0 ~ 25.5)	0.1
	LAG TIME CONSTANT	0 / 1	04AD	00FF	0000 ~ 00FF (0 ~ 255)	1
	PID LOWER LIMIT FREQUENCY	0 / 1	03D2	FFFF	0 ~ Fmax	0.01
PID DEVIATION LIMIT SELECTION		0 / 1	04BE	0080	0000: No PID deviation lim. (0) 0080: PID deviation limited (1)	—
1	PID DEVIATION UPPER LIMIT	0 / 1	04C8	00FF	0000 ~ 0032 (0 ~ 50)	1
	PID DEVIATION LOWER LIMIT	0 / 1	04C9	00FF	0000 ~ 0032 (0 ~ 50)	1
PG INPUT: NUMBER OF PULSES		0 / 1	040E	FFFF	0001 ~ 270F (1 ~ 9999)	1
PG INPUT: NUMBER OF PHASES		0 / 1	04B9	0001	0000: Single-phase input (1) 0001: Two-phase input (2)	—
DROOPING CONTROL ENABLE		0 / 1	04B9	0002	0000: OFF (0) 0002: ON (1)	—
1	DROOPING CONTROL AMOUNT	0 / 1	0451	00FF	0000 ~ 0064 (0 ~ 10.0)	0.1
OVERRIDE CONTROL SELECTION		0 / 1	04C1	0007	0000: OFF (0) 0001: FCRR (1) 0002: FCIV (2) 0003: FCRX (3) 0004: FCPG (4) 0005: FCPNL (5) 0006: FCOPT (6) 0007: FCMLT (7)	—
7	OVERRIDE MULTIPLIER INPUT SELECTION	0 / 1	04C1	0038	0000: Reference (0) 0008: KRR (1) 0010: KIV (2) 0018: KRX (3) 0020: KBIN (4)	—
	OVERRIDE CHANGE MULTIPLIER	0 / 1	0420	FFFF	FC18 ~ 03E8 (-100.0 ~ 100.0)	0.1

TOSHIBA

GROUP: COMMUNICATION SETTING PARAMETERS

Function / Title		Bank	Address	Mask	Adjustment Range	Multiplier	
RS232 BAUD RATE		1	04AE	0018	0000: 2400 baud (0) 0008: 4800 baud (1) 0010: 9600 baud (2)	—	
NUMBER OF DATA BITS		1	04AE	0040	0000: 7 bits (0) 0040: 8 bits (1)	—	
PARITY SETTING		1	04AE	0080	0000: Even parity (0) 0080: Odd parity (1)	—	
INVERTER ID NUMBER		1	04B1	00FF	0000 ~ 00FF (0 ~ 255)	1	
COMMUNICATION SELECTION		1	04AE	0007	0000: OFF (0) 0001: RS485 (1) 0002: F-10, DNet, RIO (2) 0003: TOSLINE S-20 (3) 0004: 12 bit binary input (4) 0005: 3-digit BCD (0.1Hz) (5) 0006: 3-digit BCD (1Hz) (6)	—	
1	MASTER/SLAVE SELECTION	1	04AF	0018	0000: Slave (0) 0008: Master (frequency command) (1) 0010: Master (output frequency) (2)	—	
	RS485 BAUD RATE	1	04AF	0004	0000: Normal mode (0) 0004: High-speed mode (1)	—	
2	TOSLINE-F10 COMMAND INPUT	1	04B0	0003	0000: OFF (0) 0001: Frequency command (1) 0002: Command input (2) 0003: Both (1) and (2) (3)	—	
	TOSLINE-F10 MONITOR OUTPUT	1	04B0	003C	0000: (0) 0020: (8) 0004: (1) 0024: (9) 0008: (2) 0028: (10) 000C: (3) 002C: (11) 0010: (4) 0030: (12) 0014: (5) 0034: (13) 0018: (6) 0038: (14) 001C: (7) 003C: (15)	—	
	TOSLINE-F10 COMM ERROR MODE	1	04B0	0080	0000: Data cleared (0) 0080: Data retained (1)	—	
3	TOSLINE-S20 RECEIVE ADDRESS	1	04CE	FFFF	0000 ~ 03FF (0 ~ 1023)	1	
	TOSLINE-S20 TRANSMIT ADDRESS	1	04D0	FFFF	0000 ~ 03FF (0 ~ 1023)	1	
	TOSLINE-S20 COMMAND INPUT	1	04D2	001F	0000 ~ 001F (0 ~ 31)	1	
	TOSLINE-S20 MONITOR OUTPUT	1	04D3	001F	0000 ~ 001F (0 ~ 31)	1	
	TOSLINE-S20 FREQ REF ADDR SELECT	1	04D4	0001	0000: Disable (0) 0001: Enable (1)	1	
	1	TOSLINE-S20 FREQ REFERENCE ADDR	1	04D5	FFFF	0000 ~ 03FF (0 ~ 1023)	1
	TOSLINE-S20 COMM ERROR MODE	1	04D4	0002	0000: Data cleared (0) 0002: Data retained (1)	1	
	TOSLINE-S20 COMM OPTION RESET	1	02DC	0004	0000: No effect (0) 0004: Reset (1)	1	
RS485/12-BIT BINARY BIAS,GAIN		0 / 1	04AF	0020	0000: OFF (0) 0020: ON (1)	—	
1	RS485/12-BIT BINARY POINT #1 (Ref. 1)	0 / 1	04CA	00FF	0000 ~ 0064 (0 ~ 100)	1	
	RS485/12-BIT BINARY PT. #1 FREQ	0 / 1	04B2	FFFF	0000 ~ Fmax (0 ~ Fmax)	0.01	
	RS485/12-BIT BINARY POINT #2 (Ref. 1)	0 / 1	04CB	00FF	0000 ~ 0064 (0 ~ 100)	1	
	RS485/12-BIT BINARY PT. #2 FREQ	0 / 1	04B4	FFFF	0000 ~ Fmax (0 ~ Fmax)	0.01	

TOSHIBA

(Note) All parameters in GROUP:COMMUNICATION SETTING PARAMETERS (except for RS485/12-BIT BINARY BIAS,GAIN, RS485/12-BIT BINARY POINT #1,RS485/12-BIT BINARY PT. #1 FREQ,RS485/12-BIT BINARY POINT #2, and RS485/12-BIT BINARY PT. #2 FREQ) must be set in the EEPROM (bank 1) to be valid. (These parameters can be set in bank 0 (RAM), but the data settings will be written over by the values contained in the EEPROM the next time RAM is reset. Therefore, always write the data settings for these parameters to the EEPROM (bank 1)). After changing the settings of these communication parameters, reset the inverter to validate the data.

(Ref. 1) The data settings for parameters RS485/12-BIT BINARY POINT #1 and RS485/12-BIT BINARY POINT #2 are proportional to MAXIMUM OUTPUT FREQUENCY in GROUP:FUNDAMENTAL PARAMETERS #1.

Ex: If MAXIMUM OUTPUT FREQUENCY = 80Hz, RS485/12-BIT BINARY POINT #1 = 10%, RS485/12-BIT BINARY PT. #1 FREQ = 20Hz, and an 8Hz frequency command is input, the output frequency will be 20Hz.

GROUP:AM/FM TERMINAL ADJUSTMENT PARAMS

Function / Title	Bank	Address	Mask	Adjustment Range	Multiplier
FM TERMINAL FUNCTION SELECTION (Note)	0 / 1	0484	FFFF	1194: Pre-compensation reference frequency (0) 6686: Post-compensation output frequency (1) 1500: Frequency setting (2) 2576: Output current (3) 2689: DC voltage (4) 5668: Output voltage (5) 3684: Torque current (6) 2688: Excitation current (7) 7506: PID feedback value (8) 0584: Motor overload ratio (9) 0586: Inv. overload ratio (10) 0588: Dynamic braking resistor OL ratio (11) 835C: Input power (12) 835E: Output power (13) A000: Fixed output (14) 2304: Peak output current (15) 8302: Peak input voltage (16)	—
FREQUENCY METER ADJUSTMENT	0 / 1	0486	FFFF	0000 ~ FFFF	1
AM TERMINAL FUNCTION SELECTION (Note)	0 / 1	0488	FFFF	Same as FM TERMINAL FUNCTION SELECTION	—
CURRENT METER ADJUSTMENT	0 / 1	048A	FFFF	0000 ~ FFFF	1

TOSHIBA

GROUP:UTILITY PARAMETERS

Function / Title	Bank	Address	Mask	Adjustment Range	Multiplier
INDUSTRIAL APPLICATIONS (previous setting monitor for read use) Note: If data is written to this address, the previous setting displayed on the panel will be changed.	0 / 1	0438	00FF	0000: Std. shpmt. setting (0) 0001: Pump application (1) 0002: Fan application (2) 0003: Conveyor application (3) 0004: Hoist application (4) 0005: Textiles application (5) 0006: Machine tools appl. (6)	—
INDUSTRIAL APPLICATIONS (for write use) (Note, *)	0 / 1	04C2	00FF	0000: Does nothing (0) 0011: Pump application (1) 0012: Fan application (2) 0013: Conveyor application (3) 0014: Hoist application (4) 0015: Textiles application (5) 0016: Machine tools appl. (6)	—
STANDARD SETTING MODE SELECTION (Note, *) (Ref. 1)	0 / 1	04C2	00FF	0000: Does nothing (0) 0001: 50Hz std. settings (1) 0002: 60Hz std. settings (2) 0003: Factory settings (3) 0004: Trip clear (4) 0005: Save user-set param. (5) 0006: TYPE 5 reset (6) 0007: Initialize typeform (7)	—
COMMAND MODE SELECTION	0 / 1	04B7	0007	0000: Only RS232C valid (0) 0001: Terminal input valid (1) 0002: Panel input valid (2) 0003: Communication option input valid (3) 0004: local/remote valid (4)	—
FREQUENCY MODE SELECTION	0 / 1	04B7	0038	0000: Only RS232C valid (0) 0008: Terminal input valid (1) 0010: Panel input valid (2) 0018: Comm./12-bit binary option input valid (3) 0020: local/remote valid (4)	—
PANEL OPERATION MODE SELECTION (Ref. 2)	0 / 1	0452	00FB	0000 ~ 003F (0 ~ 63) (except 0004, 0008, 000C....)	1
PASS NUMBER	0 / 1	049D	00FF	0000 ~ 0063 (0 ~ 99)	1
CPU VERSION	2	8000			
ROM VERSION	3	0000	—	(Monitor only)	1
EEPROM VERSION	1	0380			
INVERTER TYPEFORM	0	05CA	—	(Monitor only)	—
STATUS MONITOR #1 DISPLAY SELECT	0 / 1	0454	FFFF	0001 ~ 0010 (1 ~ 16)	1
STATUS MONITOR #2 DISPLAY SELECT	0 / 1	0456	FFFF	0001 ~ 0010 (1 ~ 16)	1
STATUS MONITOR #3 DISPLAY SELECT	0 / 1	0458	FFFF	0001 ~ 0010 (1 ~ 16)	1
STATUS MONITOR #4 DISPLAY SELECT	0 / 1	045A	FFFF	0001 ~ 0010 (1 ~ 16)	1
FREQUENCY UNITS SCALE FACTOR	0 / 1	0412	FFFF	0000 ~ 4E20 (0.00 ~ 200.00)	0.01
FREQUENCY DISPLAY RESOLUTION	0 / 1	045D	0003	0000: 1Hz (0) 0001: 0.1Hz (1) 0002: 0.01Hz (2)	—
ACC/DEC TIME UNITS SELECTION (Ref. 3)	0 / 1	045D	0004	0000: 0.1 sec. (0) 0004: 0.01 sec. (1)	—

TOSHIBA

Function / Title		Bank	Address	Mask	Adjustment Range	Multiplier
CURRENT UNITS SELECTION		0 / 1	045D	0008	0000: % (0) 0008: A (1)	—
VOLTAGE UNITS SELECTION		0 / 1	045D	0010	0000: % (0) 0010: V (1)	—
BLIND FUNCTION SELECTION		0 / 1	045E	0001	0000: Blind (0) 0001: Selective unblinding (1)	—
1	FUNDAMENTAL PARAMS #2 BLIND	0 / 1	045E	0040	0000: Blind (0) 0040: Unblind (1)	—
	PANEL CONTROL PARAMS BLIND	0 / 1	045E	0080	0000: Blind (0) 0080: Unblind (1)	—
	TERMINAL SELECTION PARAMS BLIND	0 / 1	045F	0001	0000: Blind (0) 0001: Unblind (1)	—
	SPECIAL CONTROL PARAMS BLIND	0 / 1	045F	0002	0000: Blind (0) 0002: Unblind (1)	—
	FREQUENCY SETTING PARAMS BLIND	0 / 1	045F	0004	0000: Blind (0) 0004: Unblind (1)	—
	PROTECTION FUNCTION PARAMS BLIND	0 / 1	045F	0008	0000: Blind (0) 0008: Unblind (1)	—
	PATTERN RUN CONTROL PARAMS BLIND	0 / 1	045F	0010	0000: Blind (0) 0010: Unblind (1)	—
	FEEDBACK CONTROL PARAMS BLIND	0 / 1	045F	0020	0000: Blind (0) 0020: Unblind (1)	—
	COMMUNICATION PARAMS BLIND	0 / 1	045F	0040	0000: Blind (0) 0040: Unblind (1)	—
	INDUSTRIAL APPL:PUMP PARAMS BLIND	0 / 1	045F	0080	0000: Blind (0) 0080: Unblind (1)	—
	INDUSTRIAL APPL:FAN PARAMS BLIND	0 / 1	0460	0001	0000: Blind (0) 0001: Unblind (1)	—
	INDUSTRIAL APPL: CONVEYOR BLIND	0 / 1	0460	0002	0000: Blind (0) 0002: Unblind (1)	—
	INDUSTRIAL APPL: HOIST BLIND	0 / 1	0460	0004	0000: Blind (0) 0004: Unblind (1)	—
	INDUSTRIAL APPL: TEXTILES BLIND	0 / 1	0460	0008	0000: Blind (0) 0008: Unblind (1)	—
	INDUST APPL:MACHINE TOOLS BLIND	0 / 1	0460	0010	0000: Blind (0) 0010: Unblind (1)	—
AM/FM ADJUSTMENT PARAMS BLIND	0 / 1	0461	0001	0000: Blind (0) 0001: Unblind (1)	—	
MOTOR PARAMETERS BLIND	0 / 1	0461	0004	0000: Blind (0) 0004: Unblind (1)	—	

(Ref. 1): The data setting value will be retained in the EEPROM even if it was written to RAM (bank 0).

Note If 0000 (does nothing) is written to the EEPROM, the previous setting monitor value will become 0. Also, if the industrial application parameters selection is written to after writing to the standard setting mode selection, the standard setting mode selection's previous data setting will be cleared.

(Ref. 2): If the setting value is written to RAM only, the value displayed on the panel will not change. Also, when the setting value is written to EEPROM, the value displayed on the panel will not change until a reset is performed.

(Ref. 3): If the setting of ACC/DEC TIME UNITS SELECTION is changed after setting the ACC/DEC times, the ACC/DEC times will become 10 times or 0.1 times their former value. Therefore, always reset the ACC/DEC time settings after changing the setting of ACC/DEC TIME UNITS SELECTION.

TOSHIBA**GROUP:MOTOR RATING PARAMETERS**

Function / Title		Bank	Address	Mask	Adjustment Range	Multiplier
NUMBER OF MOTOR POLES		0 / 1	04C3	00FF	0001: (2) 0002: (4) 0003: (6) 0004: (8) 0005: (10) 0006: (12) 0007: (14) 0008: (16)	2
MOTOR RATED CAPACITY		0 / 1	041E	FFFF	0001 ~ 270F (0.1 ~ 999.9)	0.1
MOTOR TYPE		0 / 1	04BF	0030	0000:Toshiba EQPIII motor (0) 0010:Toshiba STD motor (1) 0020:Other (2)	—
2	MOTOR RATED VOLTAGE (230 / 460v units) (575v units)	0 / 1	04C6	00FF	0012 ~ 0078 (90 ~ 600)	5
	042C		001A ~ 00AC (130 ~ 860)			
	MOTOR RATED FREQUENCY	0 / 1	04C7	00FF	0000 ~ 00C8 (0 ~ 400)	2
	MOTOR RATED RPM	0 / 1	040C	FFFF	0000 ~ 270F (0 ~ 9999)	1
AUTO-TUNING ENABLE		0	04BE	0008	0000: Auto-tuning disabled (0) 0008: Auto-tuning enabled (1)	—
LOAD MOMENT OF INERTIA		0 / 1	04BF	00C0	0000: Small (0) 0040: Medium (1) 0080: Large (2) 00C0: Very large (3)	—

TOSHIBA**9.5 ASCII Character Codes**

	<i>0</i>	<i>1</i>	<i>2</i>	<i>3</i>	<i>4</i>	<i>5</i>	<i>6</i>	<i>7</i>
<i>0</i>	NUL	DLE	SP	0	@	P	`	p
<i>1</i>	SOH	DC1	!	1	A	Q	a	q
<i>2</i>	STX	DC2	"	2	B	R	b	r
<i>3</i>	ETX	DC3	#	3	C	S	c	s
<i>4</i>	EOT	DC4	\$	4	D	T	d	t
<i>5</i>	ENQ	NAK	%	5	E	U	e	u
<i>6</i>	ACK	SYN	&	6	F	V	f	v
<i>7</i>	BEL	ETB	'	7	G	W	g	w
<i>8</i>	BS	CAN	(8	H	X	h	x
<i>9</i>	HT	EM)	9	I	Y	i	y
<i>A</i>	LF	SUB	*	:	J	Z	j	z
<i>B</i>	VT	ESC	+	;	K	[k	{
<i>C</i>	FF	FS	,	<	L	\	l	
<i>D</i>	CR	GS	-	=	M]	m	}
<i>E</i>	SO	RS	.	>	N	^	n	~
<i>F</i>	SI	US	/	?	O	_	o	DEL

Note: Shaded items in the above table indicate valid RS485 communication codes.

TOSHIBA

TOSHIBA INTERNATIONAL CORPORATION

INDUSTRIAL DIVISION

13131 West Little York Rd., Houston, TX 77041

Tel: [800] 231-1412 Fax: [713] 466-8773 Telex: 762078