

M91-2-RA22 Operator Panel & Programmable Logic Controller

24VDC, 12 digital inputs, including 2 analog inputs*, 2 temperature measurement inputs** and high-speed counter/shaft encoder input, 8 relay outputs, 2 analog outputs, I/O expansion port, RS232/RS485 port

Power supply	24VDC
Permissible range	20.4VDC to 28.8VDC with less than 10% ripple
Maximum current consumption	220mA@24VDC
Digital inputs	12 pnp (source) or npn (sink) inputs. See Note 1.
Nominal input voltage	24VDC See Notes 2.
Input voltages for pnp (source):	0-5VDC for Logic '0' 17-28.8VDC for Logic '1'
Input voltages for npn (sink):	17-28.8VDC/<1mA for Logic '0' 0-5VDC/>3mA for Logic '1'
Input current	3.7mA@24VDC
Input impedance	6.5K Ω
Response time (except high-speed inputs)	10mS typical
Galvanic isolation	None
Input cable length	Up to 100 meters, unshielded
High-speed counter	Specifications below apply when inputs are wired for use as a high-speed counter input/shaft encoder. See Notes 3 and 4.
Resolution	16-bit
Input frequency	10kHz max.
Minimum pulse	40 μ s

Notes:

- All 12 inputs can be set to pnp (source) or npn (sink) via a single jumper and appropriate wiring.
- nnp (sink) inputs use voltage supplied from the controller's power supply.
- Input #0 can function as either high-speed counter or as part of a shaft encoder. In each case, high-speed input specifications apply. When used as a normal digital input, normal input specifications apply.
- Input #1 can function as either counter reset, or as a normal digital input; in either case, specifications are those of a normal digital input. This input may also be used as part of a shaft encoder. In this case, high-speed input specifications apply.

* These inputs can function as normal digital inputs or analog inputs (voltage/current), in accordance with jumper settings and wiring connections.

** These inputs can function as normal digital inputs, RTD, or thermocouple inputs, in accordance with jumper settings and wiring connections.



Warnings:

- Unused pins should not be connected. Ignoring this directive may damage the controller.
- Improper use of this product may severely damage the controller.
- Refer to the controller's User Guide regarding wiring considerations.
- Before using this product, it is the responsibility of the user to read the product's User Guide and all accompanying documentation.

Power supply, pnp (source) inputs connection

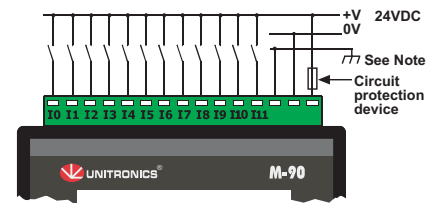

Note:

To avoid electromagnetic interference, mount the controller in a metal panel/cabinet and earth the power supply. Earth the power supply signal to the metal using a wire whose length does not exceed 10cm. If your conditions do not permit this, do not earth the power supply.

nnp (sink) inputs connection

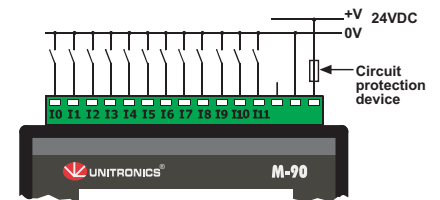

pnp (source) high-speed counter connection

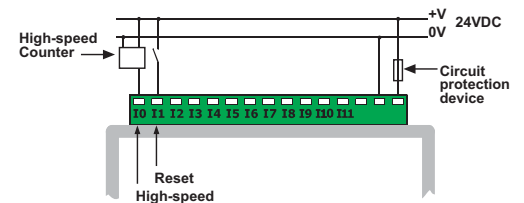

nnp (sink) high-speed counter connection

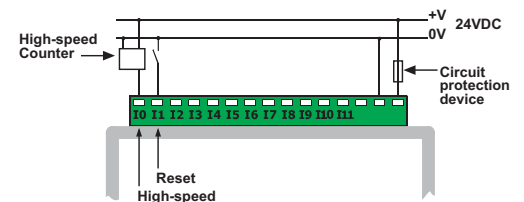

Shaft encoder connection

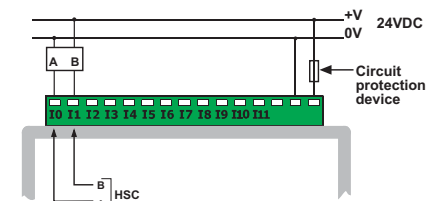

Analog Inputs	Two 14-bit, multi-range inputs: 0-10V, 0-20mA, 4-20mA See Note 1
Conversion method	Voltage to Frequency
Input impedance	12.77KΩ for voltage 37Ω for current
Isolation	None
Normal mode	
Resolution at 0-10V, 0-20mA	14-bit (16384 units)
Resolution at 4-20mA	3277 to 16383 (13107 units)
Conversion time	100mSec minimum per input (according to filter type)
Fast mode	
Resolution at 0-10V, 0-20mA	12-bit (4096 units)
Resolution at 4-20mA	819 to 4095 (3277 units)
Conversion time	30mSec minimum per input (according to filter type)
Absolute maximum rating	±15V for voltage ±30mA for current
Linearity error	0.04% maximum of full scale
Error limit	0.4% of input value
Status indication	Yes, see Note 2

Notes:

- Input #5 and input #6 can be used as analog inputs, related to signal 0V, in accordance with jumper settings and wiring connections.
- The analog value can also indicate faults, as shown below:

Value: 12-bit (Fast mode)	Value: 14-bit (Normal mode)	Input value deviates:
-1	-1	Slightly below the input range.
4096	16384	Slightly above the input range.
32767	32767	Greatly above or below the input range.

Voltage / Current connection

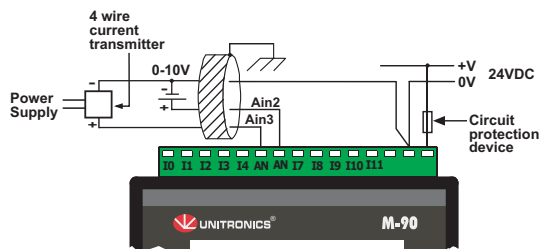

Notes:

- Shields should be connected at the signals' source.
- The 0V signal of the analog input must be connected to the controller's 0V.

Current connection

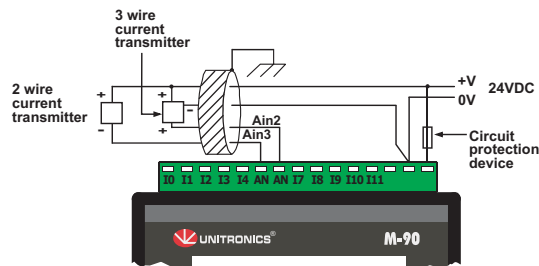

Notes:

- Shields should be connected at the signals' source.
- The 0V signal of the analog input must be connected to the controller's 0V.

Thermocouple inputs	Two differential inputs. See Note 1.
Input type	Thermocouple. See Note 2.
Input ranges	As shown in the table below
Isolation	None
Conversion method	Voltage to Frequency
Resolution	0.1°C / 0.1°F
Conversion time	100mSec minimum per input (according to filter type)
Input impedance	>10MΩ
Cold junction compensation	local, automatic
Cold junction compensation error	±1.5°C / ±2.7°F maximum
Absolute maximum rating	±0.6 VDC
Linearity error	0.04% maximum of full scale
Error limit	0.4% of input value
Status indication	None
Warm-up time	½ hour typically, ±1°C / ±1.8°F repeatability

Notes:

- Thermocouple #0: use Input #10 as positive input & Input #9 as negative input. Thermocouple #1: use Input #8 as positive input & Input #7 as negative input. To use inputs as thermocouple, set the relevant jumpers and use appropriate wiring.
- The device can also measure voltage within the range of -5 to 56mV, at resolution of 0.01mV. The device can also measure raw value frequency.

Table 1: input ranges

Type	Temperature range	Wire color	
		ANSI (USA)	BS 1843 (UK)
mV	-5 to 56mV	-	-
B	200 to 1820°C (300 to 3276°F)	+ Grey - Red	+ None - Blue
E	-200 to 750°C (-328 to 1382°F)	+ Violet - Red	+ Brown - Blue
J	-200 to 760°C (-328 to 1400°F)	+ White - Red	+ Yellow - Blue
K	-200 to 1250°C (-328 to 2282°F)	+ Yellow - Red	+ Brown - Blue
N	-200 to 1300°C (-328 to 2372°F)	+ Orange - Red	+ Orange - Blue
R	0 to 1768°C (32 to 3214°F)	+ Black - Red	+ White - Blue
S	0 to 1768°C (32 to 3214°F)	+ Black - Red	+ White - Blue
T	-200 to 400°C (-328 to 752°F)	+ Blue - Red	+ White - Blue

Thermocouple connection

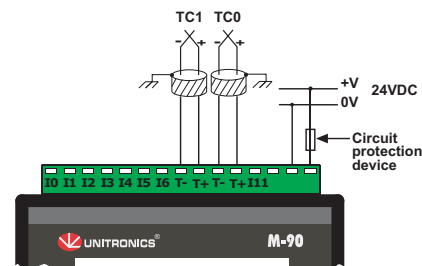

Note:

Shields should be connected at the signals' source.

RTD inputs	
Input range	Two PT100 inputs. See Note 1. -200 to 600°C (-328 to 1100°F) 1 to 320 ohm
Isolation	None
Measurement resolution	0.1°C / 0.1°F
Conversion method	Voltage to Frequency
Conversion time	300mSec minimum per input (according to filter type)
Input impedance	>10MΩ
Auxiliary current for PT100	150μA typical
Linearity error	0.04% max. of full scale
Error limit	0.4% of input value
Status indication	Yes, see Note 2

Notes:

- PT100 #0: use Input #9 & Input #10, related to CM signal (Input #11).
PT100 #1: use Input #7 & Input #8, related to CM signal (Input #11).
To use inputs as PT100, set the relevant jumpers and use appropriate wiring.
- The analog value can also indicate faults, as shown below:

Value	Possible Cause
32767	Sensor is not connected to input, or value exceeds the permissible range
-32767	Sensor is short-circuited

PT100 connection

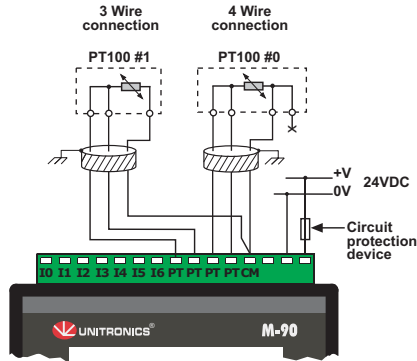

- Note:
- Shields should be connected at the signals' source.
 - 4 wire PT100 can be used by leaving one of the sense leads unconnected.

Analog outputs	
Load impedance	Two 12-bit analog outputs: 0-10V, 4-20mA, See Note
Galvanic isolation	None
Resolution	12-bit (4096 units)
Conversion time	Synchronized to scan time
Linearity error	±0.1%
Operational error limits	±0.2%

Note :
Each analog output range is defined by wiring, jumpers and within the controller's software.

Analog outputs connection

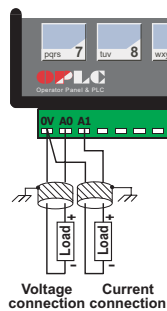

- Notes:
- Shields should be earthed, connected to the earth of the cabinet.
 - The 0V signal of the analog outputs must be the same 0V used by the controller's power supply.

Relay outputs	
Output type	8 relays (in 2 groups) See Note
Type of relay	SPST-NO (Form A)
Isolation	by relay
Output current (resistive load)	3A max per output 8A max total for common
Rated voltage	250VAC / 30VDC
Minimum load	1mA@5VDC
Life expectancy	100k operations at maximum load
Response time	10mS (typical)
Contact protection	External precautions required (see below)

Note:

Outputs #0, #1, #2 and #3 share a common signal.
Outputs #4, #5, #6 and #7 share a common signal.

Relay outputs connection

- Each Output group can be wired separately to either AC or DC as shown below.
- The power signals in the illustration below are isolated from the controller's power signals.

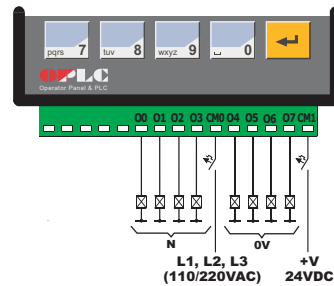

Increasing Contact Life Span

To increase the life span of the relay output contacts and protect the device from potential damage by reverse EMF, connect:

- a clamping diode in parallel with each inductive DC load.
- an RC snubber circuit in parallel with each inductive AC load.

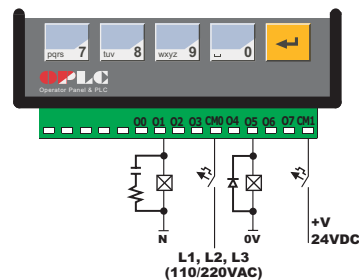

Display	STN, LCD display
Illumination	LED yellow-green backlight
Display size	2 lines, 16 characters long
Character size	5 x 8 matrix, 2.95 x 5.55mm

Keypad	Sealed membrane
Number of keys	15

PLC program	
Ladder Code Memory (virtual)	36K
Memory Bits (coils)	256
Memory Integers (Registers)	256
Timers	64
Execution time	12µsec. for bit operations
Database	1024 integers (indirect access)
HMI displays	80 user-designed displays
HMI variables	64 HMI variables are available to conditionally display and modify text, numbers, dates, times & timer values. The user can also create a list of up to 120 variable text displays, totaling up to 2K.

RS232/RS485 serial port	Used for: <ul style="list-style-type: none"> • Application Download/Upload • Application Testing (Debug) • Connect to GSM or standard telephone modem: <ul style="list-style-type: none"> - Send/receive SMS messages - Remote access programming • RS485 Networking
--------------------------------	---

RS232 (see note)	1 port
Galvanic isolation	None
Voltage limits	±20V

RS485 (see note)	1 port
Input voltage	-7 to +12V differential max.
Cable type	Shielded twisted pair, in compliance with EIA RS485

Galvanic isolation	None
Nodes	Up to 32
Baud rate	110 – 57600 bps

Note:

RS232/RS485 is determined by jumper settings and wiring as described in the document "M91 RS485 Port Settings" packaged with the controller.

I/O expansion port	Up to 96 additional I/Os, including digital & analog I/Os, temperature and weight inputs and more. (number of I/Os may vary according to expansion model)
---------------------------	---

Miscellaneous	
Clock (RTC)	Real-time clock functions (Date and Time).
Battery back-up	7 years typical at 25°C, battery back-up for RTC and system data, including variable data.
Weight	314g (11.1 oz.)
Operational temperature	0 to 50°C (32 to 122°F)
Storage temperature	-20 to 60°C (-4 to 140°F)
Relative Humidity (RH)	5% to 95% (non-condensing)
Mounting method	DIN-rail mounted (IP20/NEMA1) Panel mounted (IP65/NEMA4X)

The tables below show how to set a specific jumper to change the functionality of a specific input. To open the controller and access the jumpers, refer to the directions at the end of these specifications.

Important: Incompatible jumper settings and wiring connections may severely damage the controller.

Temperature measurement Inputs

Inputs # 7-10

JP5, JP6, JP7

Input #9 and Input #10 (universal input No.0)

To use as	JP5	JP6	JP7
Normal digital inputs*	A	A	A
Thermocouple input (See Note 1)	B	B	B
PT100 input (See Note 2)	B	A	B

Notes:

1. Thermocouple input is between Input #10 (T+) and Input #9 (T-).
2. PT100 input is connected to Input #9 and Input #10, related to CM signal (Input #11).

JP1, JP2, JP3

Input #7 and Input #8 (universal input No.1)

To use as	JP1	JP2	JP3
Normal digital inputs*	A	A	A
Thermocouple input (See Note 1)	B	B	B
PT100 input (See Note 2)	B	A	B

Notes:

1. Thermocouple input is between Input #8 (T+) and Input #7 (T-).
2. PT100 input is connected to Input #7 and Input #8, related to CM signal (Input #11).

JP11

Input #11

To use as	JP11
Normal digital input*	A
CM signal for PT100 inputs	B

Analog (Voltage/Current) Inputs

Inputs # 5-6

JP8, JP9

Input #6 (universal input No. 2)

To use as	JP8	JP9
Normal digital input*	A	A
Analog input - voltage	B	A
Analog input - current	B	B

JP4, JP10

Input #5 (universal input No. 3)

To use as	JP4	JP10
Normal digital input*	A	A
Analog input - voltage	B	A
Analog input - current	B	B

*Default factory setting

M91-2-RA22

Jumper Settings

JP12 Input type (for all digital inputs) see Note

To use as	JP12
nnp (sink)	A
pnp (source)*	B

Note:

Inputs #0-4, and #5-11 when these are set as normal digital inputs.

JP13 Analog output #0

To use as	JP13
Voltage*	A
Current	B

JP14 Analog output #1

To use as	JP14
Voltage*	A
Current	B

*Default factory setting

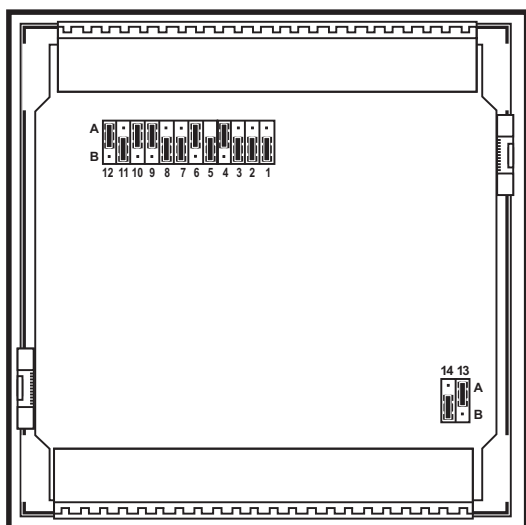

In this figure, the jumper settings will cause the inputs and the analog outputs to function as follows:

Universal Input #0 (Input #9 and #10): PT100 input, related to the CM Signal (input#11)

Universal Input #1 (Input #7 and Input #8): Termocouple input

Universal Input #2 (Input #6): Voltage input related to 0V

Universal Input #3 (Input #5): Normal npn, 24VDC digital input

Input#0 to Input #4: npn, 24VDC digital inputs.

(Note that these inputs can only function as normal digital inputs.)

Analog output #0: Voltage output

Analog output #1: Current output

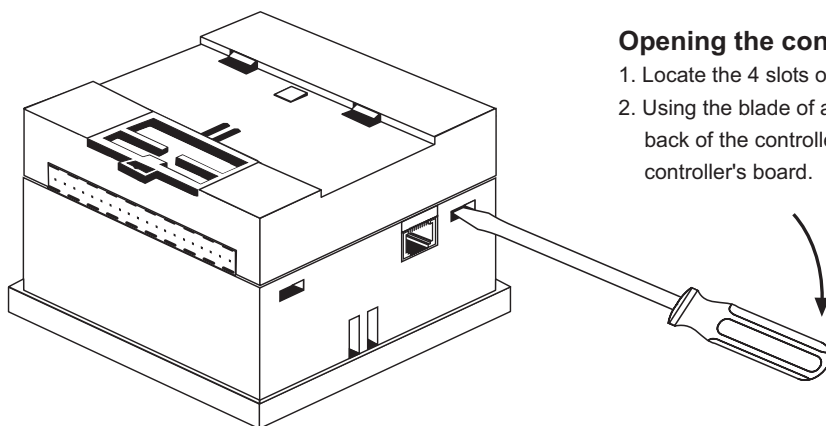

Opening the controller enclosure

1. Locate the 4 slots on the sides of the enclosure
2. Using the blade of a flat-bladed screwdriver, gently pry off the back of the controller as shown in the figure below, exposing the controller's board.

The information in this document reflects products at the date of printing. Unitronics reserves the right, subject to all applicable laws, at any time, at its sole discretion, and without notice, to discontinue or change the features, designs, materials and other specifications of its products, and to either permanently or temporarily withdraw any of the foregoing from the market.

All information in this document is provided "as is" without warranty of any kind, either expressed or implied, including but not limited to any implied warranties of merchantability, fitness for a particular purpose, or non-infringement. Unitronics assumes no responsibility for errors or omissions in the information presented in this document. In no event shall Unitronics be liable for any special, incidental, indirect or consequential damages of any kind, or any damages whatsoever arising out of or in connection with the use or performance of this information.

The tradenames, trademarks, logos and service marks presented in this document, including their design, are the property of Unitronics (1989) (R"G) Ltd. or other third parties and you are not permitted to use them without the prior written consent of Unitronics or such third party as may own them.