

M91-2-R1

12/24 VDC, 10 pnp/npn digital inputs, 1 analog input, 3 high-speed counter/shaft encoder inputs, 6 relay outputs, I/O expansion port, RS232/RS485 port

| | |
|---|--|
| Power supply | 12VDC or 24VDC |
| Permissible range | 10.2VDC to 28.8VDC with less than 10% ripple |
| Maximum current consumption | 180mA@24VDC (pnp inputs) 260mA@24VDC (npn inputs) 220mA@12VDC (pnp inputs) 330mA@12VDC (npn inputs) |
| Digital inputs | 10 pnp (source) or npn (sink) inputs. See Note 1. |
| Nominal input voltage | 12VDC or 24VDC. See Notes 2 and 3. |
| Input voltages for pnp (source): For 12VDC | 0-3VDC for Logic '0' 8-15.6VDC for Logic '1' |
| For 24VDC | 0-5VDC for Logic '0' 17-28.8VDC for Logic '1' |
| Input voltages for npn (sink): For 12VDC | 8-15.6VDC/<1.2mA for Logic '0' 0-3VDC/>3mA for Logic '1' |
| For 24VDC | 17-28.8VDC/<2mA for Logic '0' 0-5VDC/>6mA for Logic '1' |
| Input current | 4mA@12VDC 8mA@24VDC |
| Input impedance | 3KΩ |
| Response time (except high-speed inputs) | 10mS typical |
| Galvanic isolation | None |
| Input cable length | Up to 100 meters, unshielded |
| High-speed counter | Specifications below apply when inputs are wired for use as a high-speed counter input/shaft encoder. See Notes 4 and 5. |
| Resolution | 16-bit |
| Input freq. | 10kHz max. |
| Minimum pulse | 40μs |

Notes:

- All 10 inputs can be set to pnp (source) or npn (sink) via a single jumper and appropriate wiring.
- All 10 inputs can function in 12 VDC or 24 VDC; set via a single jumper and appropriate wiring.
- npn (sink) inputs use voltage supplied from the controller's power supply.
- Inputs #0, #2 and #4 can each function as either high-speed counter or as part of a shaft encoder. In each case, high-speed input specifications apply. When used as a normal digital input, normal input specifications apply.
- Inputs #1, #3 and #5 can each function as either counter reset, or as a normal digital input; in either case, specifications are those of a normal digital input. These inputs may also be used as part of a shaft encoder. In this case, high-speed input specifications apply.

Warnings:

- Unused pins should not be connected. Ignoring this directive may damage the controller.
- Improper use of this product may severely damage the controller.
- Refer to the controller's User Guide regarding wiring considerations.
- Before using this product, it is the responsibility of the user to read the product's User Guide and all accompanying documentation.

Power supply, pnp (source) inputs

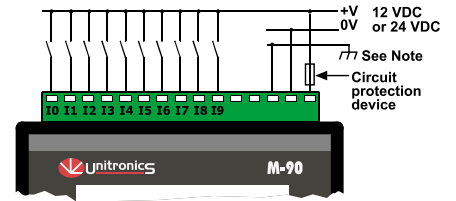

Note:

To avoid electromagnetic interference, mount the controller in a metal panel/cabinet and earth the power supply. Earth the power supply signal to the metal using a wire whose length does not exceed 10cm. If your conditions do not permit this, do not earth the power supply.

npn (sink) inputs

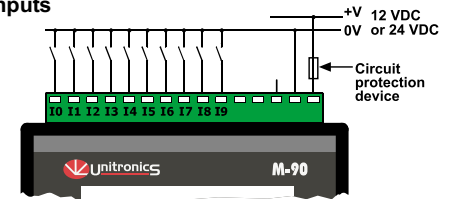

pnp (source) high-speed counter

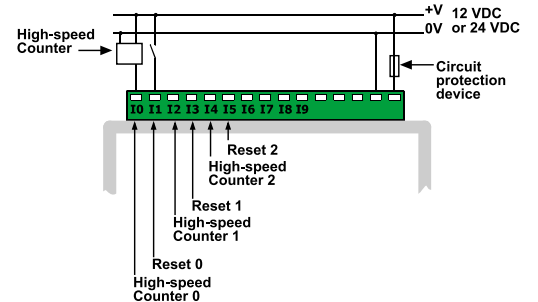

npn (sink) high-speed counter

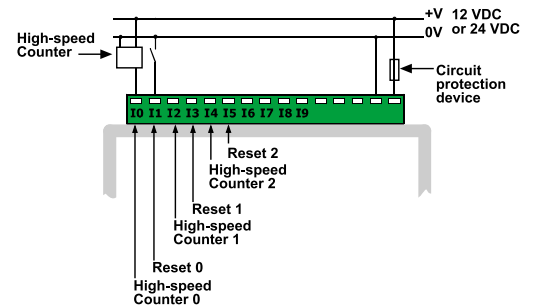

Shaft encoder

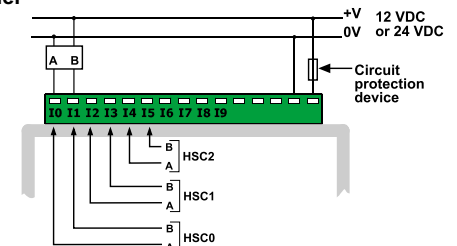

| | |
|----------------------------|---|
| Analog Input | 10-bit, multi-range input: 0-10V 0-20mA, 4-20mA |
| Conversion method | Successive approximation |
| Input impedance | >100KΩ for voltage 500Ω for current |
| Galvanic isolation | None |
| Resolution (except 4-20mA) | 10-bit (1024 units) |
| Resolution at 4-20mA | 204 to 1023 (820 units) |
| Conversion time | Synchronized to scan time |
| Absolute max. rating | ±15V |
| Full scale error | ± 2 LSB |
| Linearity error | ± 2 LSB |
| Status indication | Yes, see Note |

Note:

The analog value can also indicate when the input is functioning out of range. If an analog input deviates above the permissible range, its value will be 1024.

Voltage connection

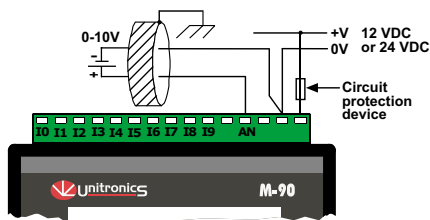

Notes:

- a. Shields should be connected at the signals' source.
- b. The 0V signal of the analog input must be connected to the controller's 0V.

Current connections

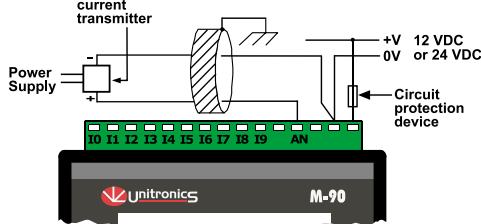
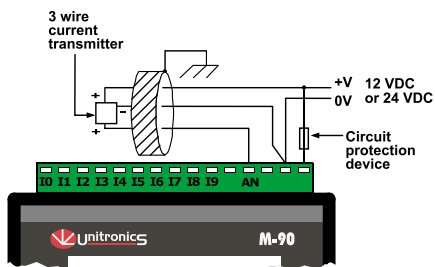
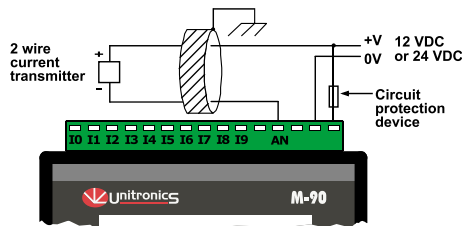

Notes:

- a. Shields should be connected at the signals' source.
- b. The 0V signal of the analog input must be connected to the controller's 0V.

| | |
|------------------------|---|
| Digital outputs | 6 relay outputs, 230VAC/ 12/24VDC |
| Output type | SPST-NO relay |
| Type of relay | Takamisawa (Fujitsu) JY-12H-K, or NAIS (Matsushita) JQ1A-12V or OMRON G6B-1114P-12VDC |
| Isolation | by relay |
| Output current | 5A max. (resistive load) 1A max. (inductive load) |
| Max. frequency | 10Hz |
| Contact protection | External precautions required |

Relay Outputs

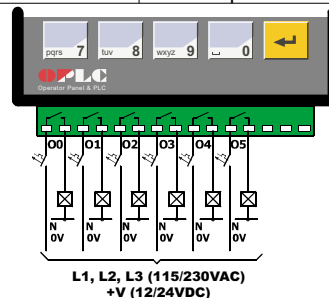

| | |
|----------------|-----------------------------|
| Display | STN, LCD display |
| Illumination | LED yellow-green backlight |
| Display size | 2 lines, 16 characters long |
| Character size | 5 x 8 matrix, 2.95 x 5.55mm |

| | |
|----------------|-----------------|
| Keypad | Sealed membrane |
| Number of keys | 15 |

| | |
|------------------------------|--|
| PLC program | |
| Ladder Code Memory (virtual) | 36K |
| Memory Bits (coils) | 256 |
| Memory Integers (Registers) | 256 |
| Timers | 64 |
| Execution time | 12µsec. for bit operations |
| Database | 1024 integers (indirect access) |
| HMI displays | 80 user-designed displays |
| HMI variables | 64 HMI variables are available to conditionally display and modify text, numbers, dates, times & timer values. The user can also create a list of up to 120 variable text displays, totaling up to 2K. |

| | |
|--------------------------------|--|
| RS232/RS485 serial port | Used for: <ul style="list-style-type: none"> • Application Download/Upload • Application Testing (Debug) • Connect to GSM or standard telephone modem: <ul style="list-style-type: none"> - Send/receive SMS messages - Remote access programming • RS485 Networking |
| RS232 (see note) | 1 port |
| Galvanic isolation | None |
| Voltage limits | ±20V |
| RS485 (see note) | 1 port |
| Input voltage | -7 to +12V differential max. |
| Cable type | Shielded twisted pair, in compliance with EIA RS485 |
| Galvanic isolation | None |
| Baud rate | 110 – 57600 bps |
| Nodes | Up to 32 |

Note: RS232/RS485 is determined by jumper settings and wiring, as described in the document "M91 RS485 Port Settings" packaged with the controller.

| | |
|---------------------------|--|
| I/O expansion port | Up to 64 additional I/Os, including digital & analog I/Os, RTD & more. |
|---------------------------|--|

| | |
|-------------------------|--|
| Miscellaneous | |
| Clock (RTC) | Real-time clock functions (Date and Time). |
| Battery back-up | 7 years typical battery back-up for RTC and system data. |
| Weight | 310g (10.9 oz.) |
| Operational temperature | 0 to 50°C (32 to 122°F) |
| Storage temperature | -20 to 60°C (-4 to 140°F) |
| Relative Humidity (RH) | 5% to 95% (non-condensing) |
| Mounting method | DIN-rail mounted (IP20/NEMA1) Panel mounted (IP65/NEMA4X) |

The tables below show how to set a specific jumper to change the functionality of the controller.
To open the controller and access the jumpers, refer to the directions at the end of these specifications.

Important:

Incompatible jumper settings and wiring connections may severely damage the controller.

**JP1
Digital inputs type**

| To use as | JP1 |
|---------------|-----|
| npn (sink) | A |
| pnp (source)* | B |

**JP2
Digital inputs voltage**

| To use as | JP2 |
|-----------|-----|
| 12VDC | A |
| 24VDC* | B |

*Default factory setting

**JP5, JP6
Power supply voltage**

| Range | JP5 | JP6 |
|------------------|-----|-----|
| 10.2 to 15.6VDC | A | A |
| 15.6 to 28.8VDC* | B | B |

**JP3
Analog input type**

| To use as | JP3 |
|----------------|-----|
| Voltage input* | A |
| Current input | B |

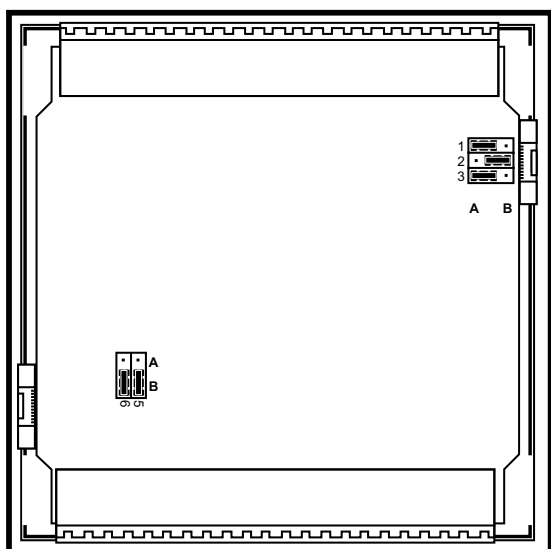

In this figure, the jumper settings will cause the controller to function as follows:

Digital inputs: npn, 24VDC inputs
Analog input: Voltage input
Power supply: 24VDC

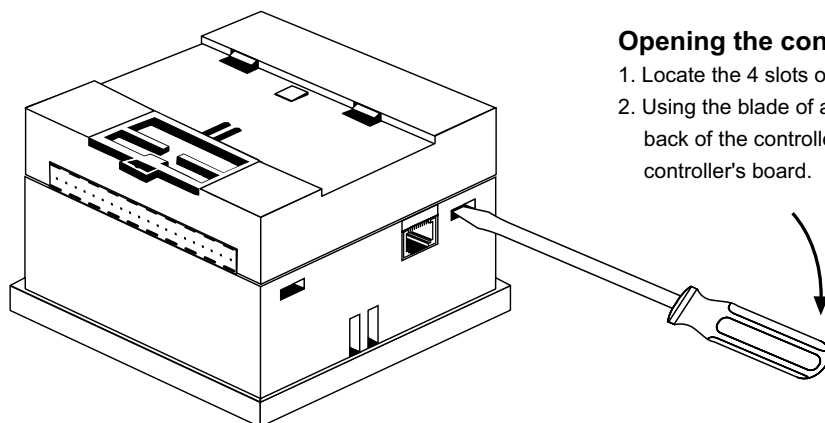
**Opening the controller enclosure**

1. Locate the 4 slots on the sides of the enclosure
2. Using the blade of a flat-bladed screwdriver, gently pry off the back of the controller as shown in the figure below, exposing the controller's board.

Unitronics reserves the right to revise this publication from time to time and to amend its contents and related hardware and software at any time.

Technical updates (if any) may be included in subsequent editions (if any).

Unitronics product sold hereunder can be used with certain products of other manufacturers at the user's sole responsibility.