

SIEMENS

efesotomasyon.com

SIMATIC



Industrial PC SIMATIC Box PC 827B

Getting Started

Introduction	1
Description	2
Application Planning	3
Mounting	4
Connecting	5
Commissioning	6
Troubleshooting	7
Dimensional drawings	8
Appendix	A

Safety Guidelines

This manual contains notices you have to observe in order to ensure your personal safety, as well as to prevent damage to property. The notices referring to your personal safety are highlighted in the manual by a safety alert symbol, notices referring only to property damage have no safety alert symbol. These notices shown below are graded according to the degree of danger.

 DANGER
indicates that death or severe personal injury will result if proper precautions are not taken.
 WARNING
indicates that death or severe personal injury may result if proper precautions are not taken.
 CAUTION
with a safety alert symbol, indicates that minor personal injury can result if proper precautions are not taken.
CAUTION
without a safety alert symbol, indicates that property damage can result if proper precautions are not taken.
NOTICE
indicates that an unintended result or situation can occur if the corresponding information is not taken into account.

If more than one degree of danger is present, the warning notice representing the highest degree of danger will be used. A notice warning of injury to persons with a safety alert symbol may also include a warning relating to property damage.

Qualified Personnel

The device/system may only be set up and used in conjunction with this documentation. Commissioning and operation of a device/system may only be performed by **qualified personnel**. Within the context of the safety notes in this documentation qualified persons are defined as persons who are authorized to commission, ground and label devices, systems and circuits in accordance with established safety practices and standards.

Prescribed Usage

Note the following:

 WARNING
This device may only be used for the applications described in the catalog or the technical description and only in connection with devices or components from other manufacturers which have been approved or recommended by Siemens. Correct, reliable operation of the product requires proper transport, storage, positioning and assembly as well as careful operation and maintenance.

Trademarks

All names identified by ® are registered trademarks of the Siemens AG. The remaining trademarks in this publication may be trademarks whose use by third parties for their own purposes could violate the rights of the owner.

Disclaimer of Liability

We have reviewed the contents of this publication to ensure consistency with the hardware and software described. Since variance cannot be precluded entirely, we cannot guarantee full consistency. However, the information in this publication is reviewed regularly and any necessary corrections are included in subsequent editions.

Table of contents

1	Introduction	5
2	Description	7
2.1	External structure.....	7
2.2	Operator Controls.....	9
2.3	Connection elements.....	10
2.4	Status displays.....	13
3	Application Planning	15
3.1	Transport.....	15
3.2	Unpacking and checking the delivery unit.....	15
3.3	Device identification data.....	16
3.4	Ambient and environmental conditions.....	17
3.5	Permitted mounting positions.....	18
4	Mounting	21
4.1	Installing the device.....	21
4.2	Installation of the device with mounting brackets.....	22
4.3	Installation of the device with the vertical mounting kit.....	23
5	Connecting	25
5.1	Connecting peripherals.....	25
5.2	Connecting the 120 V / 230 V Ac power supply.....	26
5.3	Connecting the (24 V) DC power supply.....	28
5.4	Connecting equipotential bonding.....	29
6	Commissioning	31
6.1	Requirements for commissioning.....	31
6.2	Basic commissioning - initial startup.....	31
6.3	Reinstalling the software.....	32
6.3.1	General installation procedure.....	32
7	Troubleshooting	33
7.1	General problems.....	33
8	Dimensional drawings	35
8.1	Dimensional Drawing of the Device.....	35

A	Appendix.....	39
A.1	Guidelines and declarations.....	39
A.2	Certificates and approvals.....	41
A.3	Service and support	43

Introduction

Purpose of this document

This compact documentation contains all the information you need for commissioning and using the SIMATIC Box PC 827B.

Scope of validity of this document

This documentation is valid for all delivery variants of the SIMATIC Box PC 827B and describes the delivery status as of July 2008.

Operating instructions SIMATIC Box PC 827B

The operating instructions are available on the supplied "Documentation and Drivers" CD. To view and print the operating instructions, run **Start** and follow the instructions on the screen.

The operating instructions provide useful information on many topics such as the hardware expansion options, modification of the system configuration and technical data.

Conventions

In this documentation the product name SIMATIC Box PC 827B is also abbreviated as Box PC or device. The abbreviations CP will be used for CP 1616 onboard and Vista for Windows Vista Ultimate.

Description

2.1 External structure

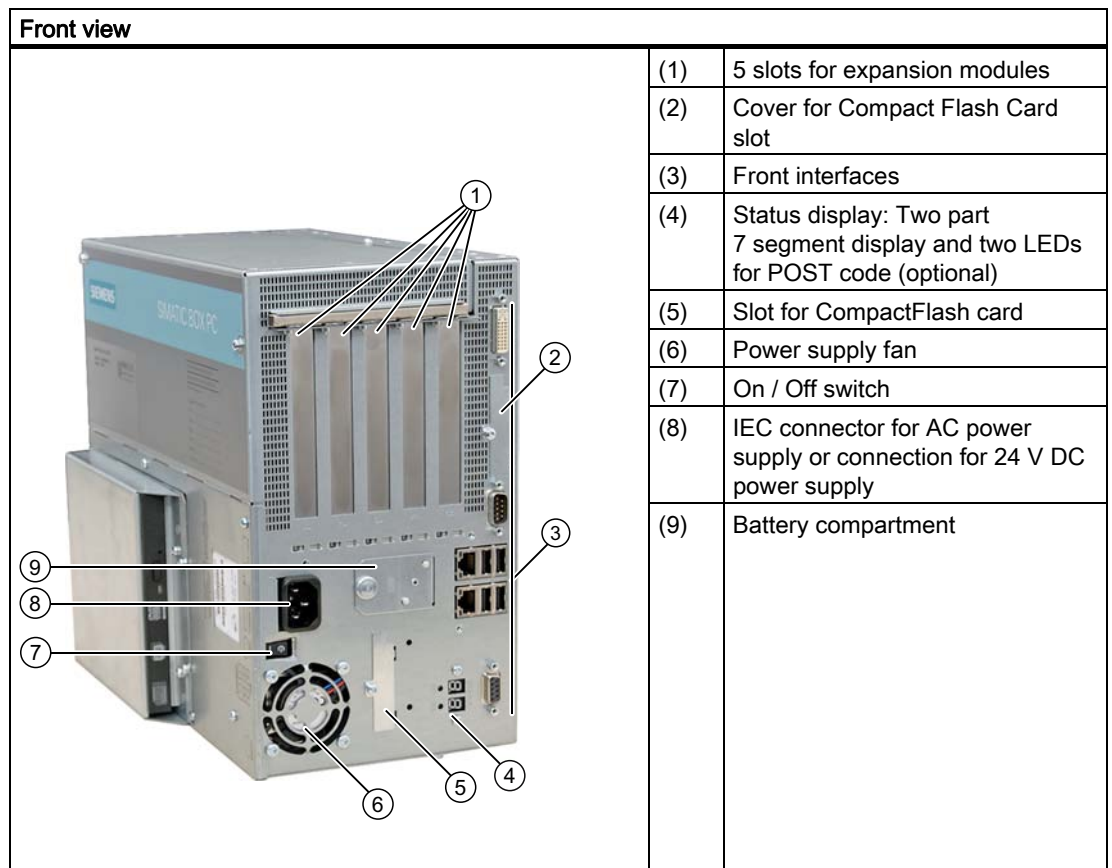

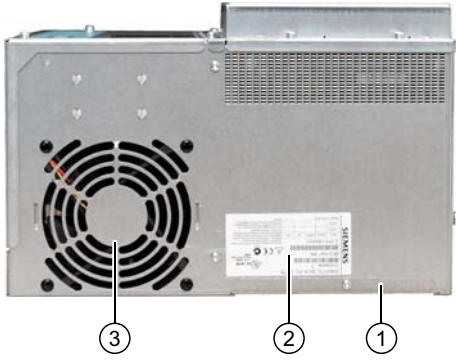

Description

2.1 External structure



Rear view	
	(1) Steel cover plate for the operator panel interfaces
	(2) Rating label with serial number
	(3) Device fan

Side view (drive side)	
	(1) Input data of the power supply
	(2) Drive bay module for hard disks and DVD burner

Bottom	
	(1) Connection for equipotential bonding 

2.2 Operator Controls

On / Off switch

On / Off switch	Description
 The image shows the rear panel of a SIMATIC Box PC 827B. A red circle highlights the On/Off switch, which is a small, dark, rectangular component located on the left side of the panel, below the power input area. Other visible components include a fan, various ports, and a power connector.	<p>The On / Off switch does not disconnect the device from mains. When the switch is in position  (Off), the device is still supplied with mains voltage in order to generate the internal auxiliary voltage for the power supply.</p>

 **WARNING**

The On/Off switch does not disconnect the device from the supply system.

NOTICE

Close the operating system before shutting down the device with the on/off switch, otherwise data may be lost.

2.3 Connection elements

Interfaces

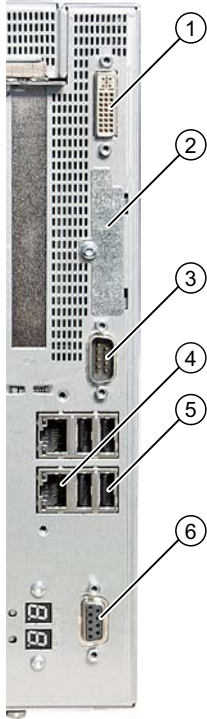
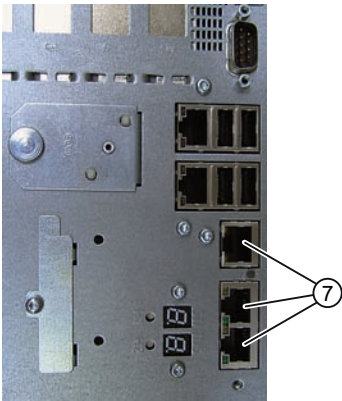
Arrangement of the ports on the front of the device			
	Pos	Description	Description
	(1)	DVI/VGA	DVI/VGA connection for CRT or LCD monitor with DVI interface, VGA via DVI/VGA adapter
	(2)	CompactFlash card	Slot for Compact Flash card
	(3)	COM	Serial V.24 port
	(4)	ETHERNET	2 RJ45 Ethernet connections for 10/100/1000 Mbps
	(5)	USB 2.0	4 ports for USB devices (only 2 ports can be simultaneously used as high current)
	(6)	PROFIBUS/MPI	MPI interface (RS485, electrically isolated), optional 9-pin D-sub socket (optional product model)
	(7)	PROFINET	CP 1616 onboard interface, three RJ45 connectors (optional product characteristic)

The interfaces available on the device have been numbered to uniquely distinguish between them. This may deviate from the operating system numbering.

Interfaces for connecting operator panels / displays

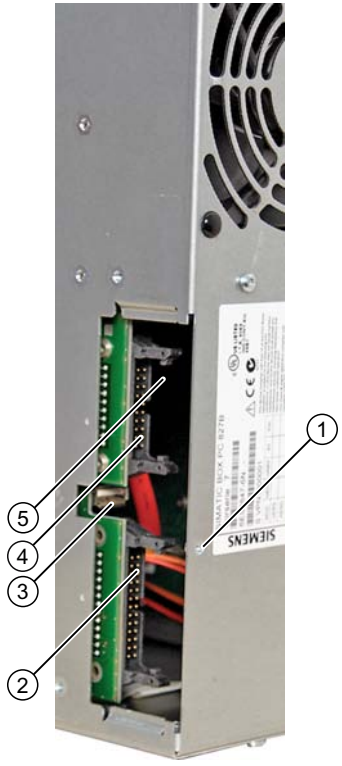
Arrangement of the ports	
	(1) Retaining screw for the steel cover plate that covers the interfaces described below.
	(2) I/O interface for connecting front panel components
	(3) USB 2.0 for front
	(4) LVDS display interface for TFT displays up to 1024 x 768 pixels
	(5) Access to 2nd LVDS display interface for TFT displays up to 1280 x 1024

AC power supply

Position of the IEC power connector	Description
	IEC power connector to AC power supply of the device. The maximum permitted power range is 100 V AC to 240 V AC.

DC power supply

Position of the DC power connector	Description
 The image shows the rear panel of a SIMATIC Box PC 827B. A green DC power connector is located on the left side of the panel. To its right, there are several other ports including a power switch, a fan, and various communication ports.	Plug connector for DC power supply of the device (1) + (24 V DC) (2) - (ground) (3) PE (ground terminal)

2.4 Status displays

PROFINET status display			
			
Display	Meaning	LEDs	Description
SF PROFINET (optional)	Status display for CP 1616 onboard	OFF	<ul style="list-style-type: none"> CP not available CP disabled No error, communication established Charging in progress
		Flashes slowly	<ul style="list-style-type: none"> Link status error IO controller: IO device cannot be addressed IO controller: Duplicate IP address
		Flashes rapidly	Exception error: diagnostics via Web or SNMP is no longer possible
		AN	<ul style="list-style-type: none"> Diagnostics information available No communication established.

Virtual status displays			
The two "virtual" CP 1616 LEDs are only visible in the SIMATIC software and can be read via SNMP.			
PROFINET	Virtual LEDs	RUN	CP is active
		STOP	CP is in the stop state
		Flashes	The states "flashes slowly" or "flashes rapidly" do not exist.

Status display

The status display consists of two 7-segment displays with two dual-color LEDs.

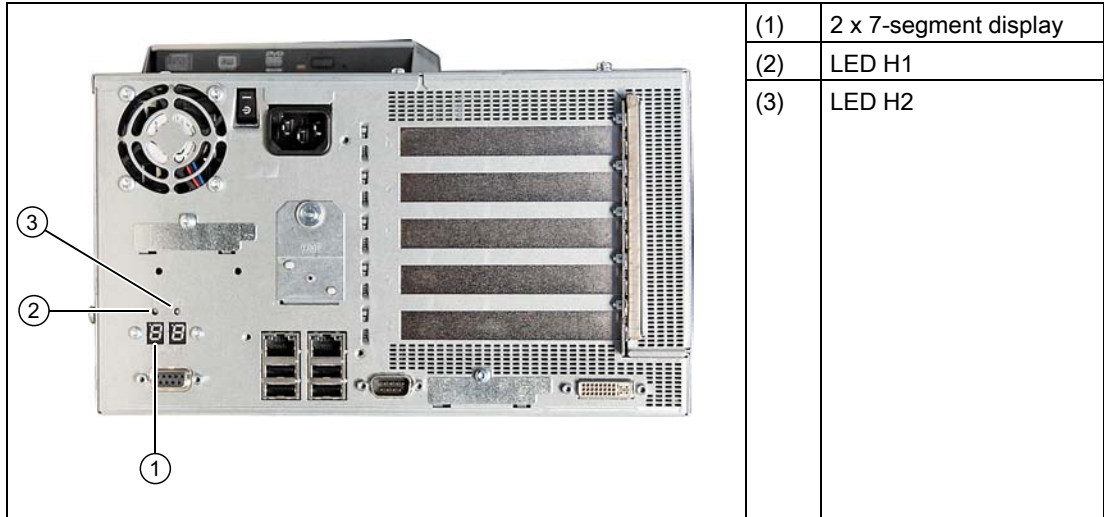

	7-segment display	LED H1	LED H2
Power on (= status display test)	88h	Orange	Orange
BIOS self test	xxh (see BIOS postcode)	Off	Off
BIOS self test completed	00h	Off	Off
Operating system is running or application-driven	00h	Off	Off
Operating system is shut down	88h	Off	Off

Application Planning

efesotomasyon.com

3.1 Transport

Despite the device's rugged design, its internal components are sensitive to severe vibrations or shock. You must therefore protect the PC from severe mechanical stress when transporting it.

You should always use the **original packaging** for shipping and transporting the device.

CAUTION

Risk of damage to the device!

When transporting the PC in cold weather, it may be submitted to extreme variations in temperature. In this situation, ensure that no moisture (condensation) develops on or inside the device.

If condensation has developed on the device wait at least 12 hours before you switch it on.

3.2 Unpacking and checking the delivery unit

Unpacking the device

Note the following points when you unpack the unit

- It is advisable not to dispose of the original packing material. Keep it in case you have to transport the unit again.
- Please keep the documentation in a safe place. It is required for initial commissioning and is part of the device.
- Check the delivery unit for any visible transport damage.
- Verify that the shipment contains the complete unit and your separately ordered accessories. Please inform your local dealer of any disagreements or transport damage.

3.3 Device identification data

The device can be clearly identified with the help of this identification data in case of repairs or theft.

Enter the following data in the table below:

- Serial number: The serial number (S VP...) is found on the rating plate.

Rating plate

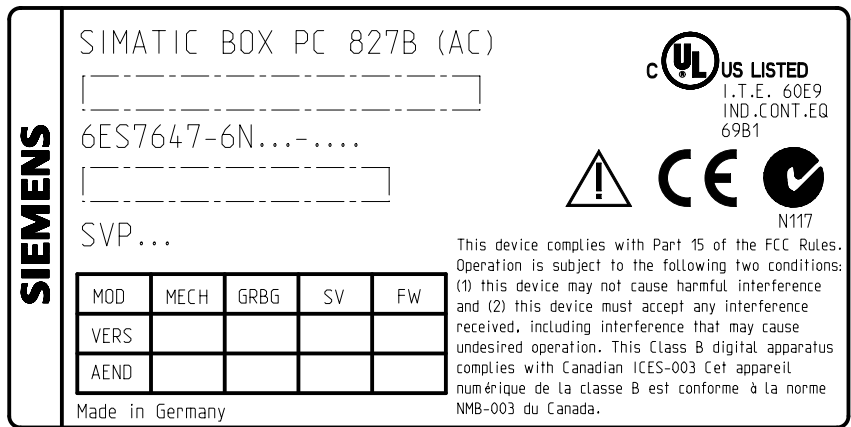

- Order number of the device
- Ethernet addresses: The Ethernet addresses of the device can be viewed in the BIOS Setup (F2) under "Main > Hardware Options > Ethernet Address".
- Microsoft Windows "Product Key" on the "Certificate of Authenticity" (COA). The COA label is bonded to the device. The Product Key is always required to reinstall the operating system.

COA label

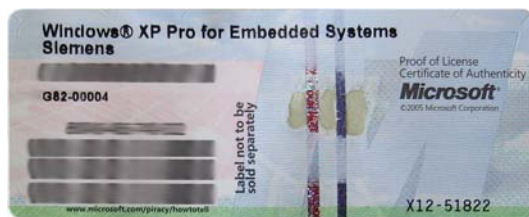

Serial number:	S VP ...
Order No.	6ES ...
Microsoft Windows Product Key	
Ethernet address 1	
Ethernet address 2	
CP 1616 onboard layer 2	

3.4 Ambient and environmental conditions

When you plan your project, you should make allowances for:

- The climatic and mechanical environmental conditions specified in the specifications given in your operating instructions.
- At least 100 mm space should be left free around the ventilation slots, in order that the PC receives sufficient ventilation.
- Do not cover the vent slots of the device.
- The device together with its AC power supply fulfils the requirements for fire protected enclosures according to EN 60950-1. Therefore it can be installed without any additional fire protective covering.
- The device with DC power supply does not fulfill the requirements according to EN 60950-1 in the power supply unit area. The device must therefore be installed in such a way is part of an operating area with restricted access (e.g. a locked switchgear cabinet, control panel or server room).
- Always observe the mounting positions permitted for this device.
- The connected or built-in peripherals should not introduce a counter emf in excess of 0.5 V into the device.

 WARNING
Failure to adhere to these conditions when mounting the system voids the approvals based on UL 60950-1, UL 508 and EN 60950-1!

3.5 Permitted mounting positions

PC mounting positions according to UL60950-1/UL508/EN60950-1/CSA22.2 No. 60950-1

An inclination of $\pm 20^\circ$ is permitted for all approved mounting positions.

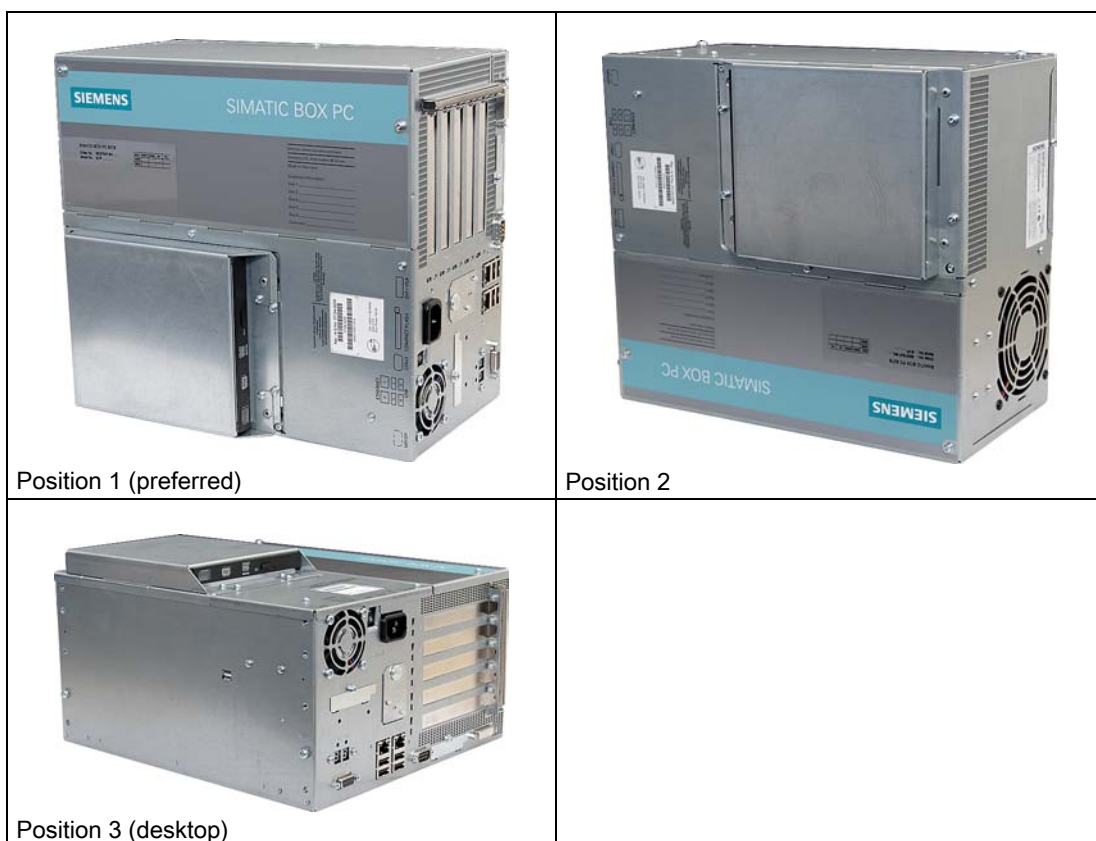

Additional PC mounting positions according to UL508/CSA 22.2 No. 142

An inclination of $\pm 15^\circ$ is allowed in this mounting position.

**Note**

CD/DVD and floppy drives cannot be operated in this position. The CD drawer opens upward or downward which can lead to mechanical damages in the drawer mechanism.

NOTICE

When using the device in the area of Industrial Control Equipment (UL 508), ensure that the it is classified as "Open Type". A mandatory requirement for approval or operation according to UL 508 is therefore installation of the device in an enclosure certified for UL 508.

NOTICE

Mounting positions 4 and 5 are also permitted for the Information Technology Equipment area when the device is mounted in an enclosure that fulfills the requirements stipulated by sections 4.6 and 4.7.3 of IEC/UL/EN/DIN EN 60950-1.

Mounting

4.1 Installing the device

The device is particularly suitable for installation in switch cabinets.

 **WARNING**

Function test while installing the device in machines or execute systems

Following the results of a risk analysis, additional protection equipment on the machine or the system is necessary to avoid endangering persons. With this, especially the programming, configuration and wiring of the inserted I/O modules have to be executed, in accordance with the necessary risk analysis identified safety performance (SIL, PL or Cat.). The intended use of the device has to be secured.

The correct use of the device has to be verified with a function test on the system. This test can detect programming, configuration and wiring errors. The test results have to be documented and if necessary inserted into the relevant inputs.

4.2 Installation of the device with mounting brackets

Screw-mounting the brackets

Two angle brackets are included in the product package. You can attach these to the PC enclosure using six M3 x 6 mm screws.

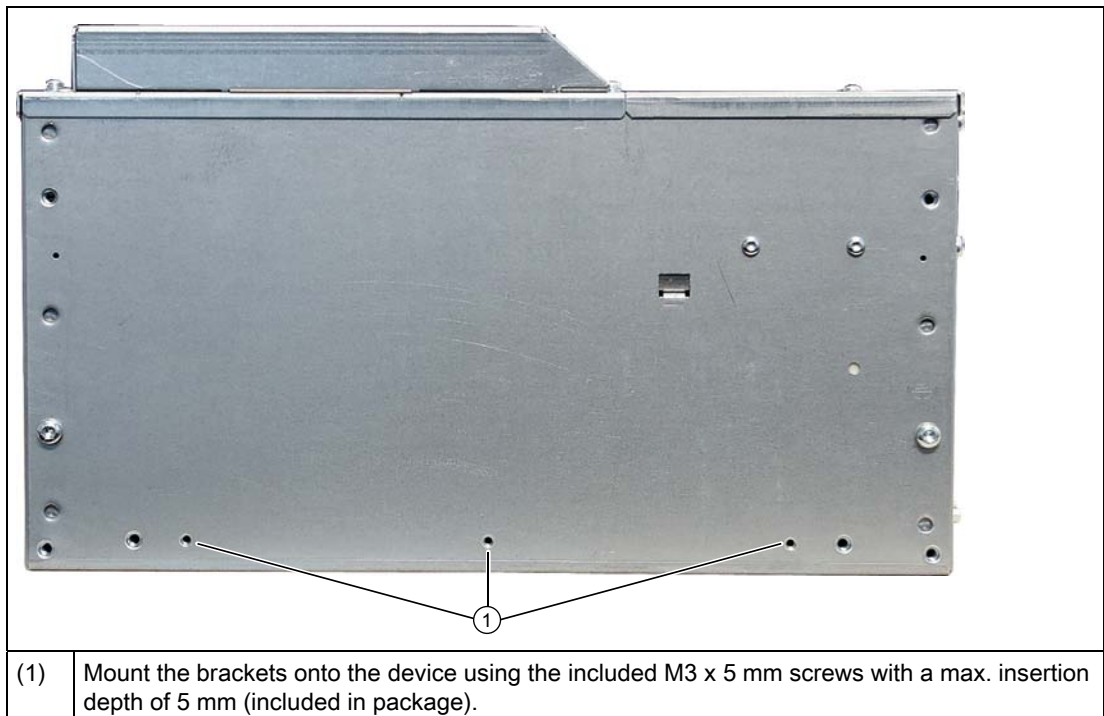

Instructions for wall mounting

Mounting examples		
Material	Hole diameter	Mounting
Concrete	8 mm diameter, 60 mm depth	Dowel: 8 mm, 50 mm screws 4 mm, 50 mm
Plasterboard (min. 13 mm thick)	14 mm diameter	Tilting dowel diameter 4 mm min. length 50 mm
Metal (min. 2 mm thick)	5 mm diameter	Metal screws diameter 4 mm min. length 15 mm

⚠ WARNING

Ensure that the wall is capable of carrying at least four times the total weight of the device (including the brackets and expansion modules). The total weight is approx. 9 kg.

4.3 Installation of the device with the vertical mounting kit

With the available optional vertical mounting kit you have the possibility to implement a place saving installation.

Mounting the vertical mounting plate onto the device

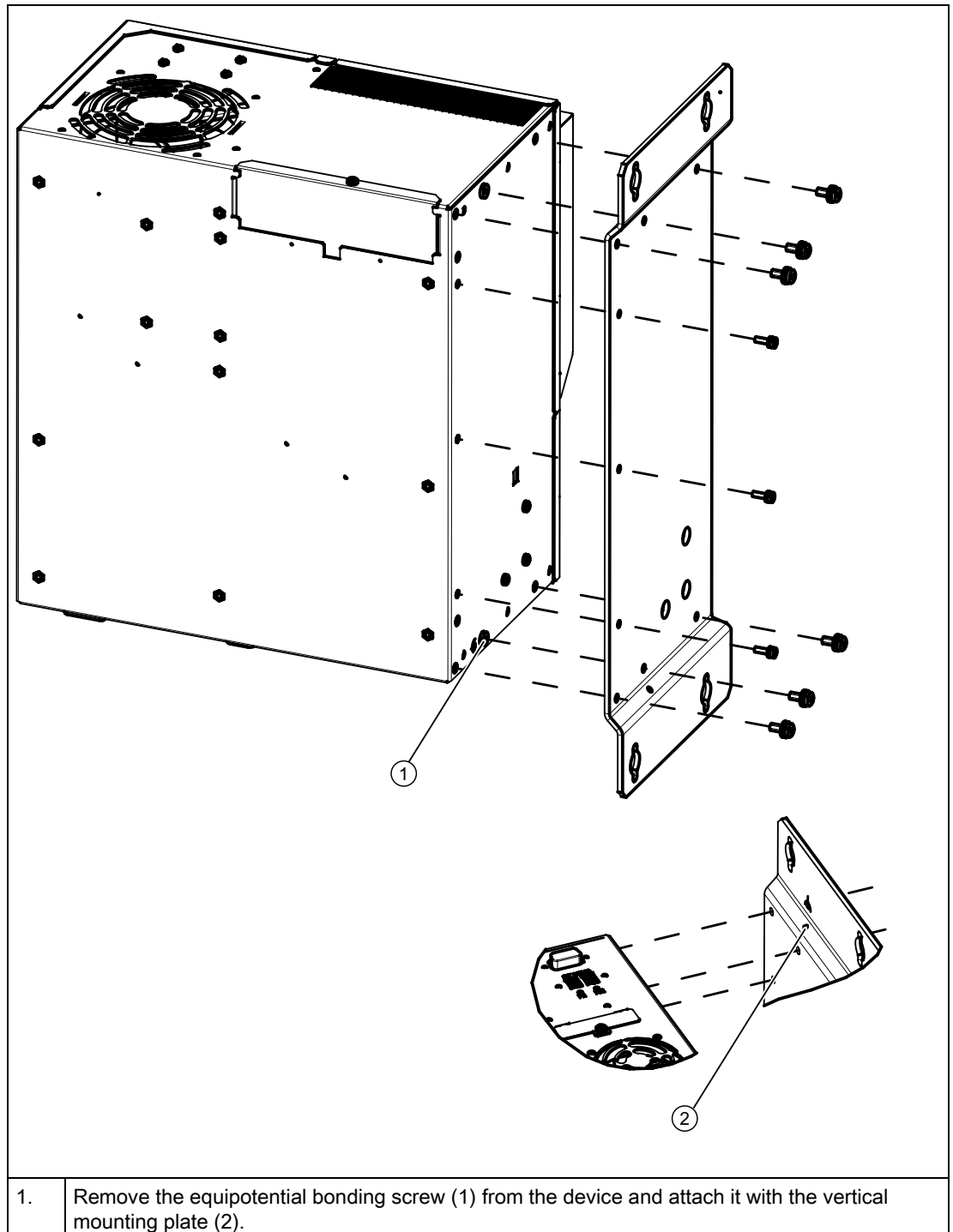

4.3 Installation of the device with the vertical mounting kit

- | | |
|----|--|
| 2. | Attach the vertical mounting plate with four M4 screws and three M3 screws to the device |
|----|--|

Note

Following instructions in the "Permitted mounting positions" section.

Connecting

5.1 Connecting peripherals

Note before connecting

NOTICE

Connect only peripheral devices approved for industrial applications to EN 61000-6-2:2005.

Note

Hot-plug peripheral devices (USB) may be connected while the PC is in operation.

CAUTION

Peripheral devices that are incapable of hot-plugging may only be connected after the device has been disconnected from the power supply.

CAUTION

Strictly adhere to the specifications in the manuals for the peripheral devices.

NOTICE

The connected or built-in peripherals should not introduce a counter emf into the device.

A counter emf greater than 0.5 V to ground on the + 3.3 VDC / + 5 VDC / + 12 VDC power rail due to a connected or integrated component can prevent normal operation or even destroy the computer.

When measuring the counter emf, remember the following:

- The computer in question must be turned off and the power supply connector should be plugged in.
- During the measurement, all cables from the plant to the computer should be connected.
- All other components in the plant must be active.

5.2 Connecting the 120 V / 230 V Ac power supply

Note before connecting the device

Note

The varying voltage power supply module is designed for operation on 120/230/240 V AC networks. The setting of the voltage range takes place automatically.

 WARNING

Do not connect or disconnect power and data cables during thunderstorms.

 WARNING

The device is designed for operation on grounded power supply networks (TN networks to VDE 0100, Part 300, or IEC 60364-3).

Operation on ungrounded or impedance-grounded power networks (IT networks) is prohibited.

 WARNING

The permitted nominal voltage of the device must conform with local mains voltage.

CAUTION

The mains connector must be disconnected to fully isolate the device from mains. Ensure easy access to this area.

A master mains disconnect switch must be installed if the device is mounted in a switch cabinet.

Always ensure free and easy access to the power inlet on the device or that the safety power outlet of the building installation is freely accessible and located close to the device.

Note

The power supply contains an active PFC (Power Factor Correction) circuit to conform to the EMC guidelines.

Uninterruptible AC power systems (UPS) must supply a sinusoidal output voltage in the normal and buffered mode when used with SIMATIC PCs with an active PFC.

UPS characteristics are described and classified in the standards EN 50091-3 and IEC 62040-3. Devices with sinusoidal output voltage in the normal and buffered mode are identified with the classification "VFI-SS-...." or "VI-SS-....".

Localized information

For countries other than the USA and Canada:

230 V supply voltage

This device is equipped with a safety-tested power cable which may only be connected to a grounding outlet. If you choose not to use this cable, you must use a flexible cable of the following type: Min 18 AWG conductor cross-section and 15-A / 250-V shockproof connector. The cable set must be compliant with the safety regulations and stipulated IDs of the country where the system is to be installed.

For the USA and Canada:

For the United States and Canada, a CSA or UL-listed power cord must be used.

The connector must be compliant with NEMA 5-15.

120 V AC power supply

To be used is a flexible power cord approved to UL and with CSA label, and which has the following features: Type SJT with three leads, min. 18 AWG conductor cross-section, max. 4.5 m in length and parallel ground contact connector 15 A, min. 125 V.

240 VAC power supply

Use a flexible power cord which is approved to UL and CSA, and which has the following features: Type SJT with three conductors, min. 18 AWG conductor cross-section, max. length 4.5 m, and tandem grounded connector 15 A, min. 250 V.

Connecting

How to connect the device to the 120 V AC / 230 V AC power supply	
1	Ensure that the ON/OFF switch is in position  (Off) when you plug in the power cord in order to avoid unintentional startup of the device.
2	Connect the IEC connector
3	Connecting the power cord to the power socket
4	Fasten the cable with the supplied power plug latch, if necessary.



5.3 Connecting the (24 V) DC power supply

Note before connecting the device

 WARNING
<p>Only connect the device to 24 V DC power supply systems which meet the requirements of a safe extra-low voltage (SELV); in addition, a protective conductor must be connected. The conductors must withstand the short-circuit current of the 24 V DC power source, so that a short-circuit will not damage the cable. Only connect cables with a minimum cross-section of 1.3 mm² (AWG16) and a maximum cross-section of 3.3 mm² (AWG12).</p>

NOTICE
<p>The 24 V DC power source must be adapted to the input data of the device (see specifications).</p>

Connecting

Steps for connecting the device to the 24 V DC power supply	
1	Ensure that the ON/OFF switch is in the  (OFF) position to prevent unintentional startup of the device when connecting it to the 24 V power supply.
2	Switch off the 24 V DC power source.
3	Insert the DC power plug. (1) 24 V DC (2) ground (3) protective conductor

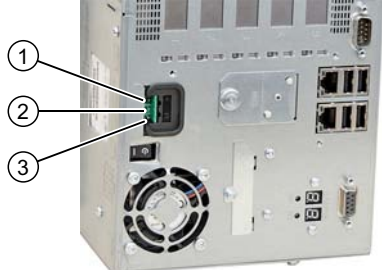

5.4 Connecting equipotential bonding

The equipotential bonding terminal (M4 thread) on the device (large surface, large-area contact) must be connected to the PE conductor on the cabinet or system in which the device is to be installed. The minimum cross-section is 5 mm².

The equipotential bonding terminal ensures that interference signals generated by external power supply cables, signal cables or cables to the I/O modules are safely discharged to earth.

Connecting equipotential bonding

Connect the equipotential bonding terminal on the device (large surface, large-area contact) to the central grounding busbar of the cabinet in which the device is installed. The minimum cross-section is 5 mm².



Commissioning

6.1 Requirements for commissioning

- Connect the peripherals, such as the keyboard, mouse, monitor and the power supply, before putting the device into operation.
- The operating system of your device is preinstalled on the hard disk.

CAUTION**Risk of damage to the device!**

Make sufficient allowances for the device to acquire room temperature before you put it into use. If condensation has developed on the device wait at least 12 hours before you switch it on.

6.2 Basic commissioning - initial startup

The PC operating system is automatically set up the **first** time you switch on the device.

Procedure:

1. Set the ON / Off switch to I position (On). The PC performs a POST. During the self-test, this message appears:

Press <F2> to enter SETUP or <ESC> to show the Boot menu

2. Wait until this message is cleared, then follow the instructions on the screen.
3. Type in the Product Key as required. You find this key on the "Certificate of Authentication", in the "Product Key" line.

NOTICE

The PC may not be switched off when you run setup.

Do **not** change the default BIOS settings, otherwise the operating system setup may become corrupted.

4. Automatic restart

After you have entered all necessary information and after the operating system setup is completed, the PC is automatically restarted and displays the user interface of the relevant operating system.

When you switch on the PC now, the user interface of the operating system or logon dialog of the operating system (with Windows XP Embedded) is automatically opened when the startup routine is completed.

6.3 Reinstalling the software

6.3.1 General installation procedure

In case of software errors, you can reinstall your software using the Recovery CD, the Documentation and Drivers CD or the Restore DVD.

Recovery CD:

Contains the tools for setting up hard disk drives and the operating system.

Documentation and Drivers CD:

Contains the documentation and the hardware drivers.

Restore DVD:

Contains a hard disk image file with the original software (operating system with installed hardware drivers).

Troubleshooting

efesotomasyon.com

7.1 General problems

This chapter provides you with tips on how to localize and troubleshoot frequently occurring problems.

Problem	Possible causes	Remedy
The device is not operational	There is no power supply to the device.	<ul style="list-style-type: none"> • Check the power supply, the network cable and the power plug. • Check if the On/Off switch is in the correct position.
	Device is being operated outside the specified ambient. conditions	<ul style="list-style-type: none"> • Check the ambient conditions. • After transport in cold weather, wait approximately 12 hours before switching on the device.
Windows no longer boots	Settings in the BIOS Setup are incorrect	<ul style="list-style-type: none"> • Check the setting in the BIOS Setup "SATA/PATA Configuration" submenu • Check the setting in the BIOS Setup Boot menu
The external monitor remains dark.	The monitor is switched off.	Switch on the monitor.
	The monitor is in "power save" mode.	Press any key on the keyboard.
	The brightness button has been set to dark.	Increase the screen brightness. For detailed information, refer to the monitor operating instructions.
	The power cord or the monitor cable is not connected.	<ul style="list-style-type: none"> • Check whether the power cord has been properly connected to the monitor and to the system unit or to the grounded shockproof outlet. • Check whether the monitor cable has been properly connected to the system unit and to the monitor.
		If the monitor screen still remains dark after you have performed these checks, please contact your technical support team.
The mouse pointer does not appear on the screen.	The mouse driver is not loaded.	Check if the mouse driver is correctly installed.
	The mouse is not connected.	<p>Check whether the mouse lead is connected to the system unit. If you are using an adapter or extension for the mouse lead, check the connectors.</p> <p>Should the mouse cursor still not be visible on-screen after completing these checks and measures, contact technical support.</p>

7.1 General problems

Problem	Possible causes	Remedy
Wrong time and/or date on the PC.		<ol style="list-style-type: none"> 1. Press <F2> during the boot sequence to open BIOS Setup. 2. Set the time and date in the setup menu.
Although the BIOS setting is OK, the time and data are still wrong.	The backup battery is dead.	Replace the backup battery.
USB device not responding.	The USB ports are disabled in your BIOS.	Use a different USB port or enable the port.
	USB 2.0 device connected but USB 2.0 is disabled.	Enable USB 2.0.
	Operating system does not support the USB port.	Enable USB Legacy Support for the mouse and keyboard. For other devices you need the USB drivers for the respective operating system.
DVD: The front loader does not open.	The device is switched off or the open/close button is disabled by a software application.	Emergency removal of the data medium: <ol style="list-style-type: none"> 1. Switching off the device 2. Insert a pointed object, a pin for example, or an opened paper clip into the emergency extraction opening of the drive. Apply slight pressure to the contact until the front loader opens. 3. Pull the loader further out.

Dimensional drawings

8.1 Dimensional Drawing of the Device

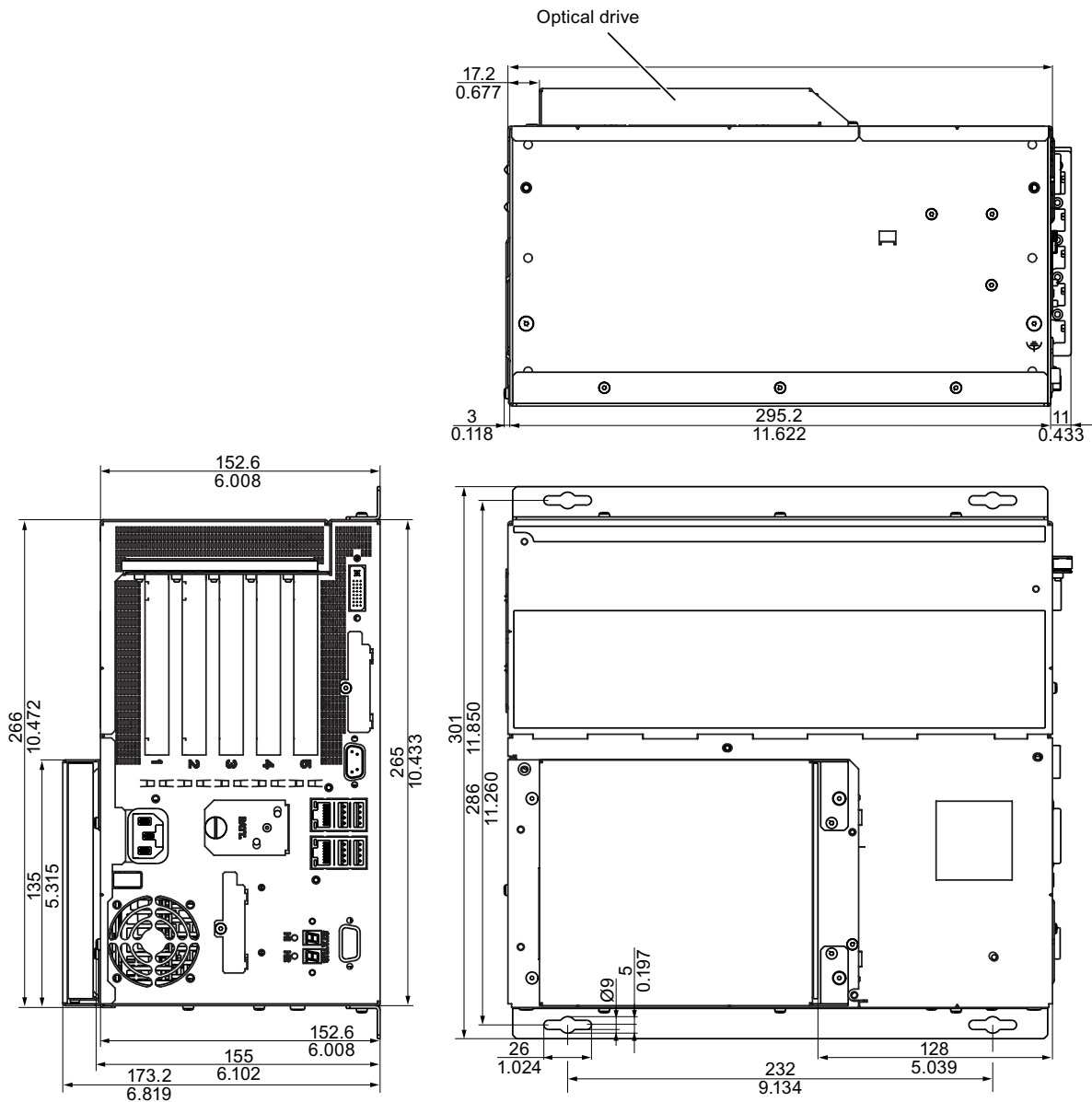

Figure 8-1 Dimensional drawing for mounting with angle bracket

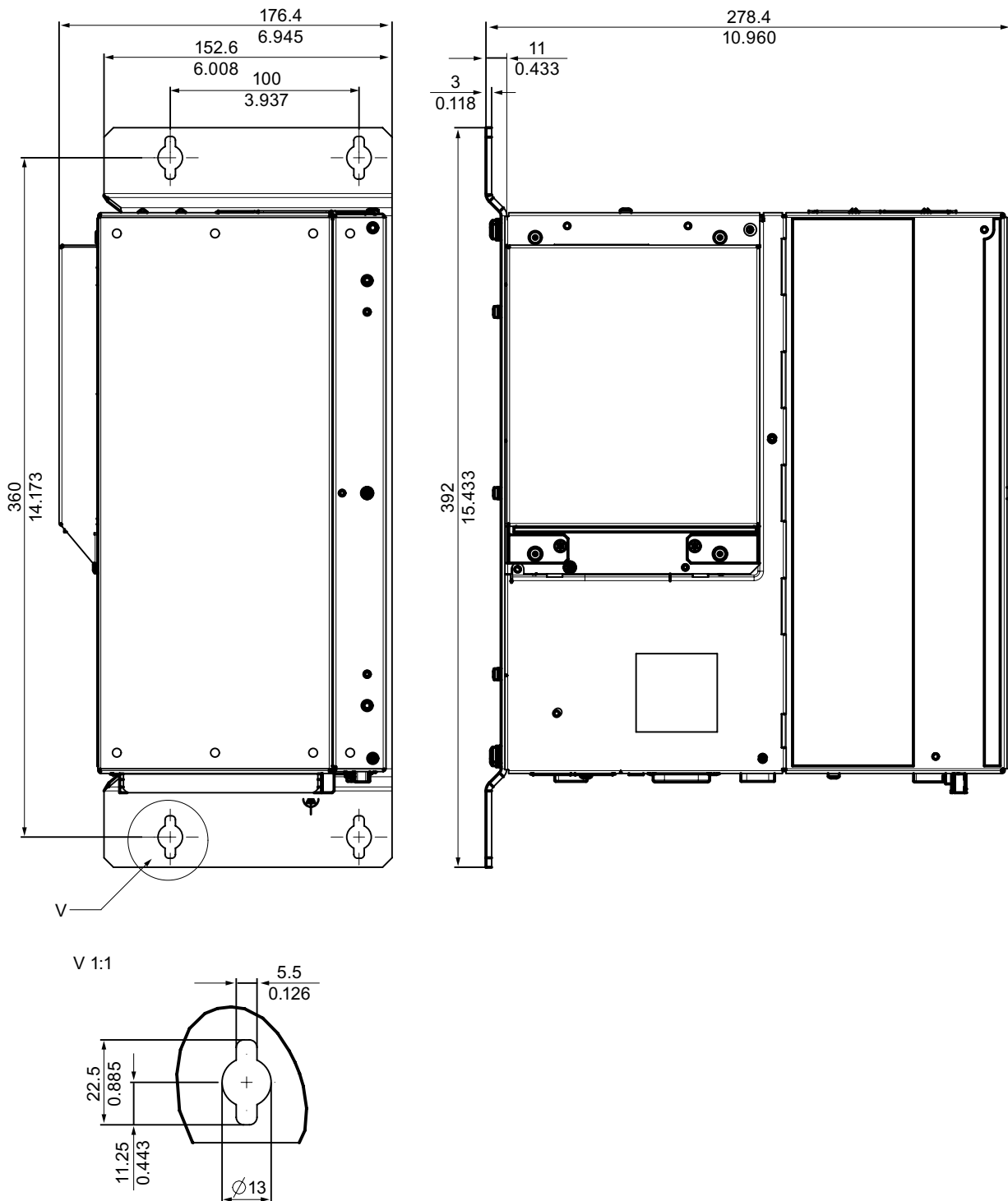

Figure 8-3 Dimensional drawings for vertical mounting (model without DVD burner and without WinAC backup battery)

NOTICE

When mounting devices with optical drives or WinAC backup batteries change the fitting depth.

Appendix

A.1 Guidelines and declarations

Notes on the CE Label

 The following applies to the SIMATIC product described in this documentation:

EMC Directive

The devices fulfill the requirements for the EC directive "2004/108/EEC Electromagnetic Compatibility", and the following fields of application applies according to this CE label:

Fields of application	Requirement for	
	Emitted interference	Immunity to interferences
Residential, business and trade areas and small businesses.	EN 61000-6-3: 2007	EN 61000-6-1: 2007
Industry	EN 61000-6-4: 2007	EN 61000-6-2: 2005

The device is also compliant with EN 61000-3-2:2006 (harmonic currents) and EN 61000-3-3:1995 +A1:2001 +A2:2005 (voltage fluctuation and flicker.)

Low-voltage directive

The devices with AC and DC power supply are compliant with the requirements of the EC Directive 2006/95/EEC "Low-Voltage Directive." Conformance with this directive has been verified according to EN60950-1:2001 +A11:2004.

Declaration of conformity

The EC declaration of conformity and the corresponding documentation are made available to authorities in accordance with the EC directives stated above. Your sales representative can provide these on request.

Note the installation guidelines

The installation guidelines and safety instructions given in this documentation have to be noted during commissioning and operation.

Connecting peripherals

Noise immunity requirements to EN 61000-6-2 are met if connected peripherals are suitable for industrial applications. Peripheral devices are only be connected via shielded cables.

A.2 Certificates and approvals

ISO 9001 certificate

The Siemens quality management system for all production processes (development, production and sales) meets DIN ISO 9001:2000 requirements.

This has been certified by DQS (the German society for the certification of quality management systems).

Q-Net certificate no.: DE-001108 QM

Software License Agreement

The device is shipped with preinstalled software. Please observe the respective license agreements.

Approvals for the USA, Canada and Australia

Product safety

The following approval is available for the device:	
	Underwriters Laboratories (UL) to Standard UL 60950-1, Report E11 5352 and Canadian Standard C22.2 no. 60950-1 (I.T.E), or to UL508 and C22.2 no. 142 (IND.CONT.EQ)

EMC

USA	
Federal Communications Commission Radio Frequency Interference Statement	This equipment has been tested and found to comply with the limits for a Class A digital device, pursuant to Part 15 of the FCC Rules. These limits are designed to provide reasonable protection against harmful interference when the equipment is operated in a commercial environment. This equipment generates, uses, and can radiate radio frequency energy and, if not installed and used in accordance with the instruction manual, may cause harmful interference to radio communications. Operation of this equipment in a residential area is likely to cause harmful interference in which case the user will be required to correct the interference at his own expense.
Shielded Cables	Shielded cables must be used with this equipment to maintain compliance with FCC regulations.
Modifications	Changes or modifications not expressly approved by the manufacturer could void the user's authority to operate the equipment.
Conditions of Operations	This device complies with Part 15 of the FCC Rules. Operation is subject to the following two conditions: (1) this device may not cause harmful interference, and (2) this device must accept any interference received, including interference that may cause undesired operation.

CANADA	
Canadian Notice	This Class A digital apparatus complies with Canadian ICES-003.
Avis Canadien	Cet appareil numérique de la classe B est conforme à la norme NMB-003 du Canada.

AUSTRALIA	
	This product meets the requirements of the AS/NZS CISPR22.

A.3 Service and support

Local information

If you have questions about the products described in this document, you can find help at:
<http://www.siemens.com/automation/partner>

Technical documentation for SIMATIC products

Further documentation for SIMATIC products and systems can be found at:
<http://www.siemens.de/simatic-tech-doku-portal>

Easy Shopping at the Mall

Catalog & online ordering system <http://www.siemens.com/automation/mall>

Training

All the training options are listed at: <http://www.siemens.com/sitrain>
Find a contact at: Phone: +49(911) 895-3200

Technical support

Tel +49 180 5050 222
Fax +49 180 5050 223
<http://www.siemens.com/automation/service>

You will find support request web form at:
<http://www.siemens.de/automation/support-request>

When you contact the customer support, please have the following information for the technician on hand:

- BIOS version
- Order No. (MLFB) of the device
- Installed additional software
- Installed additional hardware

Online support

Information about the product, Support and Service, right through to the Technical Forum, can be found at: <http://www.automation.siemens.com>

After-sales information system for SIMATIC PC / PG

Information about contacts, drivers, and BIOS updates, FAQs and Customer Support can be found at: <http://www.siemens.com/asis>

