

S5 PLC

- S5 Ethernet Adapter
- Accessories S5 Ethernet Adapter
- INAT-X5 / -X7
- INAT Compact PCI
- Accessories INAT-X5 / -X7 and INAT Compact PCI
- PG Multiplexer

S5 Ethernet Adapter

Ethernet CP for Simatic S5
Communication, Visualisation

Universal communications processor.

Can be integrated seamlessly into existing Ethernet TCP/IP and ISO (H1) networks.

AREAS OF APPLICATION

- Ethernet interface for Simatic S5 (AG 115U, AG 135U/155U, AG 150U)
- Visualisation
- Remote maintenance of S5 via LAN and WAN
- Programming the S5 via LAN and WAN
- Communication with Siemens S7 and S5 PLCs
- Spontaneous data traffic with Fetch on Event
- Communication via Modbus on TCP with PLCs of Groupe Schneider and with I/Os (see page 67)
- Send / Receive for communication via the Socket interface (raw data)

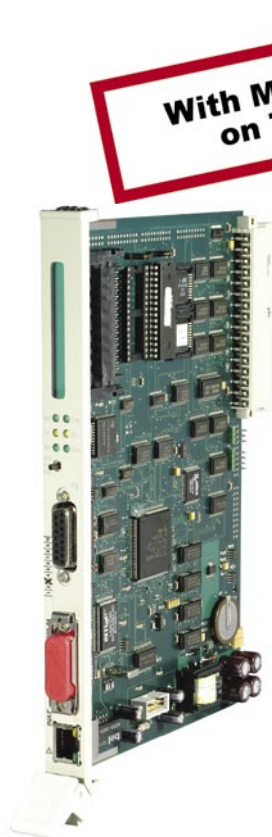

S5-TCP/IP

S5-TCP/IP

- Provides: DHCP, SNMP to MIB II, DNS, FTP

Serial interface:	1 x AS511, TTY
Ethernet interface: 10 Mbps	1 x TP (RJ45), 1 x AUI
Transport Protocols:	TCP/IP, TCP/IP with ISO on TCP (RFC1006), TCP/IP with PLC Header, ISO (H1)
Application Protocols:	S5-AP, Modbus on TCP, Send / Receive
Performance:	120 frames / s, 223 connections
Order number:	200-3000-01

Accessories S5 Ethernet Adapter

PLC cable S5-CP/PLC



PLC cable S5-CP/PLC

- TTY, 15pin D-sub male – TTY, 15pin D-sub male
- Length: 0,6 meters

	Order number:	700-1700-01
--	----------------------	-------------

RS232 / TTY cable



RS232 / TTY cable

- For serial parameterization
- RS232, 9pin D-sub female – TTY (20 mA), 15pin D-sub male
- Length: 5 meters

	Order number:	700-1500-05
--	----------------------	-------------

S5 Flash EPROM



S5 Flash EPROM

- Short 128 KB, functionality of 6ES5374-1KG11

	Order number:	700-2400-128
--	----------------------	--------------

INAT-X5 / -X7

Modular CPU for the S5

High Performance CPU for the S5.
With TCP/IP interface.

efesotomasyon.com

AREAS OF APPLICATION

- Applicable in automation systems of 115U, 135U/155U and 150U of the Simatic S5
- Compatible with CPU 416 with RS 7 Software
- Compatible with CPU 945 (941, 942, 943, 944) or CPU 948 (946/947, 928) with RS 5 Software
- Synchronous mode: S7 and S5 Program run concurrently (see page 45)
- Particularly suitable for extensions of present plants
- IT function (Email Client, Webserver, FTP)
- Upgrade your S5 PLC to an S7 PLC in a Flash

INAT-X5 / -X7

**Now with
synchronous mode**



INAT-X5 / -X7 mit
10 / 100 Mbps Ethernet

- Including serial parameterization cable (see page 48)

Serial interfaces:	1 x AS511 (TTY) or RS232 with 15pin D-sub female, 1 x RS232 with 9pin D-sub male
Ethernet interfaces: 10 / 100 Mbps	2 x TP (RJ45) (2 port Switch)
Interfaces optional:	Keyboard and mouse via PS2 via PC-MIP: 4 x RS232 4 x RS422 / 485 graphics 1.280 x 1.024
Transport Protocols:	TCP/IP, TCP/IP with ISO on TCP (RFC1006)
Serial Protocols:	3964(R), RK512, ASCII, STX/ETX
RAM Extension:	64 MB SDRAM, 128 KB Bios Flash, 2 MB retained SRAM
Mass storage:	Compact Flash 1 socket for CF cards or microdrives
Power supply:	5 V +/- 5% @5A
Dimensions:	Height: 6 HE Width: 8 TE
Order numbers:	
X5 / X7 CPU for AG 115U	700-4300-01
X5 / X7 CPU for AG 135U/155U	700-4310-01
X5 / X7 CPU for AG 150U	700-4320-01
RS 5 software, compatible with CPU 945	700-4330-01
RS 5 software, compatible with CPU 948	700-4331-01
RS 7 software, compatible with CPU 416/945 (synchronous mode)	700-4340-01
RS 7 Software, compa- tible with CPU 416/948 (synchronous mode)	700-4341-01

Note:

The software can only be used in combination with a X CPU hardware. For each X CPU one software module can be ordered. Please specify the order number of the RS Software with your X CPU order!

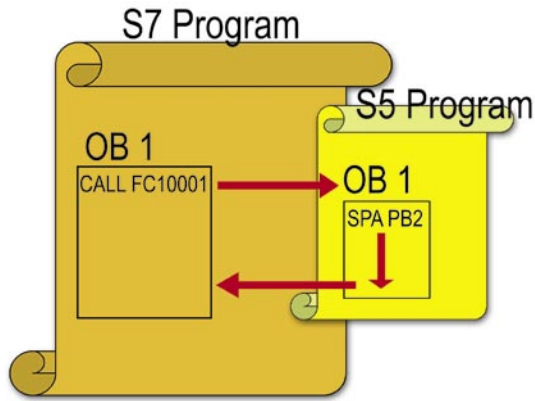

What is synchronous mode?

- The RS 7 Software (700-4340-01 and 700-4341-01) supports the so-called synchronous mode.
- This means that besides the S7 functions the complete S5 functions are contained in the X7.
- The existing S5 program is completely executable in the X7 CPU.
- Blocks from the S5 program do not have to be re-edited. They can be called in the S7 program.

S5 program and S7 program run simultaneously!

ADVANTAGES:

- Step 5 blocks that can only be ported to S7 with high complexity, remain in Step 5 and are called from the Step 7 operating system.
- Access to external periphery, where blocks are only available in Step 5.
- Existing S5 hardware and S5 programs can be integrated into systems, that do not support S5 components (e.g. Simatic PC S7)
- Time-consuming and cost-intensive converting of programs is not applicable.

In the Past to Upgrade S5 to S7

- Purchasing new hardware
- Conversion of Programs
- ⇒ Time-consuming, cost-intensive

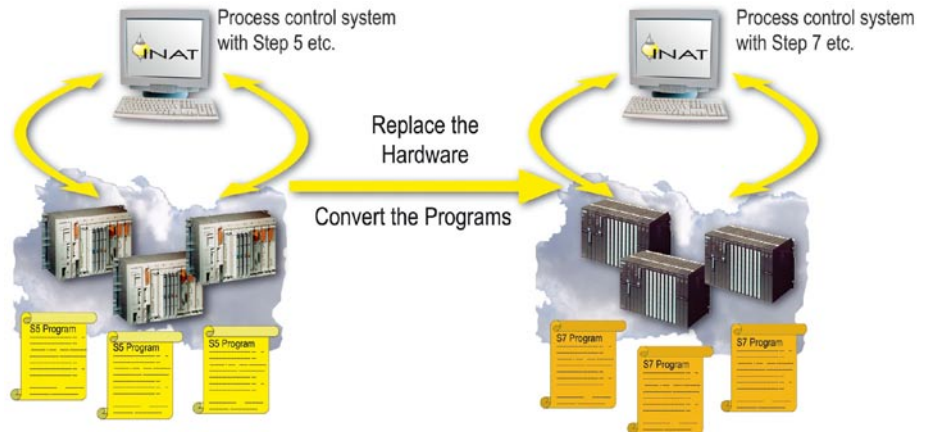

Upgrade Today

- Hardware remains constant (exception: CPUs)
- S5 Program remains constant
- S7 Program and S5 Program run concurrently
- ⇒ Time-saving, cost-effective

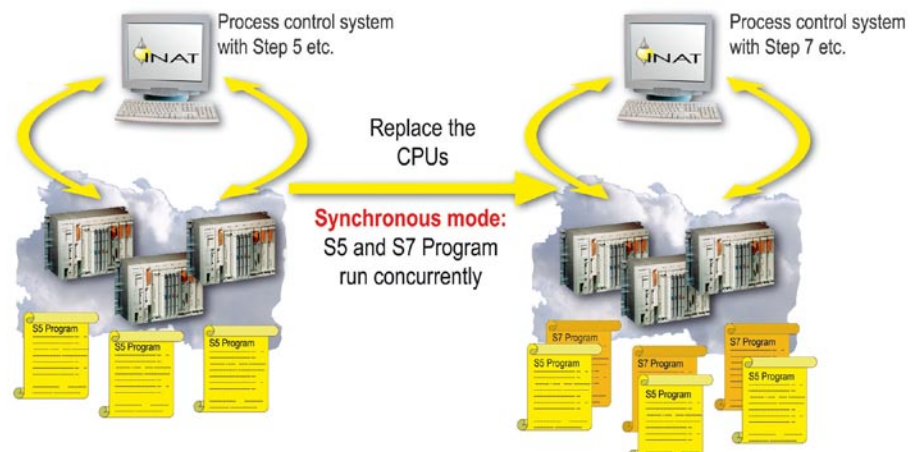

INAT Compact PCI CPU

Modular CPU
for CPCI
module rack

High Performance for mounting in a CPCI module rack.
With TCP/IP interface.

AREAS OF APPLICATION

- Compact CPU for CPCI module rack
- Compatible with CPU 416
- Compatible with CPU 945 (941, 942, 943, 944) or CPU 948 (946/947, 928)
- Synchronous mode: S7 and S5 Program run concurrently (see page 45)
- Particularly suitable for extensions of present plants
- IT functions (Email-Client, Webserver, FTP)
- Upgrade in a Flash

INAT Compact PCI CPU

Now with
synchronous mode

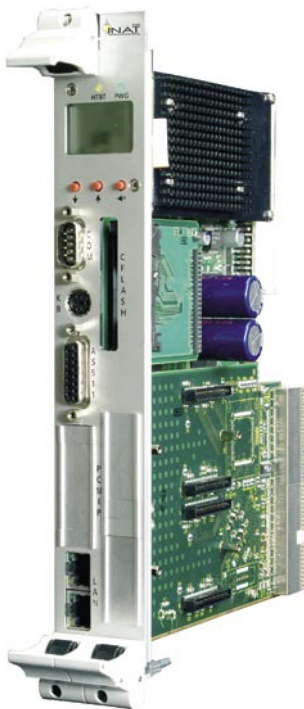

INAT CPCI CPU with
10 / 100 Mbps Ethernet

- Including serial parameterization cable (see page 48)
- Including bus coupler S5 ↔ Compact-PCI
- Extension up to 3 PC-MIP-Modules without additional board

Serial interfaces:	1 x AS511 (TTY) or RS232 with 15pin D-sub female, 1 x RS232 with 9pin D-sub, male
Ethernet interfaces: 10 / 100 Mbps	2 x TP (RJ45) (2 port Switch)
Interfaces optional:	Keyboard and mouse via PS2 via PC-MIP: 4 x RS232 4 x RS422 / 485 graphics 1.280 x 1.024
Transport Protocols:	TCP/IP, TCP/IP with ISO on TCP (RFC1006)
Serial Protocols:	3964(R), RK512, ASCII, STX/ETX
RAM Extension:	64 MB SDRAM, 128 KB Bios Flash, 2 MB retained SRAM
Mass storage:	Compact Flash 1 socket for CF cards or microdrives
Power supply:	5 V +/- 5% @5A
Dimensions:	Height: 6 HE Width: 8 TE
	Order numbers:
CPCI CPU as 945	700-7100-01
CPCI CPU as 948	700-7110-01
CPCI CPU as 416 (synchronous mode)	700-7120-01

efesotomasyon.com

Note: Compact PCI periphery on demand!

Accessories INAT-X5 / -X7 und CPCI CPU



PC MIP module
4 x RS232

PC MIP Module, 4 x RS232

- 4 asynchronous channels
- Full duplex
- 128 Byte FIFO per channel
- Non-floating

Order number:	700-1100-01
----------------------	-------------



PC-MIP module
4 x RS422 / 485

PC MIP Module, 4 x RS422 / 485

- Full duplex
- 128 Byte FIFO per channel

Order number:	700-1110-01
----------------------	-------------

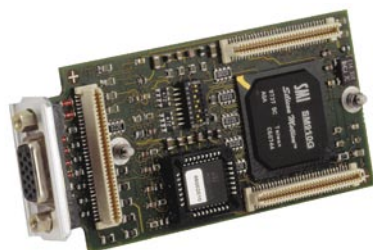

PC-MIP module
resolution 1.280 x 1.024

PC MIP Module, graphics 1.280 x 1.024

- CRT and LCD Interface
- Resolution up to 1.280 x 1.024
- 4 MB VIDEO DRAM
- 15pin HD-Sub connector

Order number:	700-1120-01
----------------------	-------------

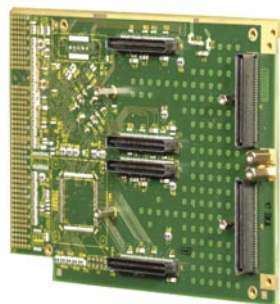

PC-MIP extension board

Extension

- Extension of the INAT-X5/-X7 up to maximal 3 modules

Order number:	700-1130-01
----------------------	-------------



INAT-S5 / CPCI module rack

INAT-S5 / CPCI module rack

- Integration of Simatic S5 modules and CPCI components in one module rack
- 19" slot

Bus:	Compact-PCI / S5 backplane
Power supply:	integrated ATX power supply, 230 V / 250 W
Dimensions [in mm]:	L = 360, D = 200, H = 300
	Order number:
12 x S5 und 7 x CPCI*	700-7190-01

* other versions on demand



CPCI module rack

INAT CPCI module rack

- 19" slot with 5-Slot Compact-PCI backplane

Bus:	Compact PCI
Power supply:	integrated ATX power supply, 230 V / 250 W
Dimensions [in mm]:	L = 440, D = 420, H = 130
Order number:	700-7191-01



Serial parameterization cable

Serial parameterization cable for X5, X7, CPCI CPU

- RS232, 9pin D-sub female – RS232, 15pin D-sub male
- Length: 5 meters
- included in the scope of supply of the X5 / X7 and CPCI CPU

Order number:	700-7192-01
----------------------	-------------

efesotomasyon.com

Two devices on one PG interface at the same time.
Compatible with all S5 PLCs.

AREAS OF APPLICATION

- Simultaneous operation of programming device, text display, operator panel or other process devices

PG-MUX II



PG-MUX II

- For two PGs, including connection cable (see below)

PLC interface:	TTY (20 mA), active
PG1 + PG2 interface:	TTY (20 mA), active
Protocols:	2 x AS511 or 1 x Sinec-L1-BUS and 1 x AS511
Power supply:	230 V AC and 24 V DC
Dimensions [in mm]:	L = 190, D = 110, H = 50
Order number:	400-9361-05

MINI-MUX



MINI-MUX

- For one PG and one OP, exclusive of connection cable

PLC interface:	TTY (20 mA), active
PG interface:	TTY (20 mA), active
Protocol:	AS511
OP interface:	TTY passive
Protocols:	AS511 or Sinec-L1-BUS
Power supply:	24 V DC
Dimensions [in mm]:	L = 135, D = 110, H = 50
Order number:	400-9361-01

Accessories: Connection cable Multiplexer – PLC TTY



Connection cable
Multiplexer – PLC TTY

- TTY, 15pin D-sub male – TTY, 15pin D-sub female
- Included in the scope of supply of PG-MUX
- Length: 3 meters

Order number:	400-9361-03
----------------------	-------------

Exhibitions / Events

Again in 2005 we want to meet you for one-on-one interviews. There are several possibilities to meet us:



INAT at the SPS / IPC / Drives 2004



INAT booth

**SPS / IPC / DRIVES /
Elektrische
Automatisierung
Systeme und Komponenten
Fachmesse & Kongress
Nürnberg 22.- 24. Nov. 2005**



Brennpunkt Automation (Focus Automation) offers the chance to listen to interesting lectures and to compare notes with others who work in different sectors of automation technology.

During the course of the exhibition, you can evaluate the newly introduced automation components.



The Automation Day is focused on software standards in automation technology. Automation Day is organized by „Automation“ sector of the ASQF e.V. and is aimed at decision makers, software developers and quality agents. It takes place several times a year in Germany, Austria and Switzerland.

Dates and other events
are presented at

www.inat.de