

Lenze

EN *Operating Instructions*



smd - frequency inverter
0.25 kW... 4.0 kW

Copyright © 2005 AC Technology Corporation

All rights reserved. No part of this manual may be reproduced or transmitted in any form without written permission from AC Technology Corporation. The information and technical data in this manual are subject to change without notice. AC Technology Corporation makes no warranty of any kind with respect to this material, including, but not limited to, the implied warranties of its merchantability and fitness for a given purpose. AC Technology Corporation assumes no responsibility for any errors that may appear in this manual.

All information given in this documentation has been carefully selected and tested for compliance with the hardware and software described. Nevertheless, discrepancies cannot be ruled out. We do not accept any responsibility nor liability for damages that may occur. Any necessary corrections will be implemented in subsequent editions.

This document printed in the United States

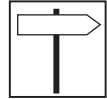

About these instructions.....	2
1 Safety information.....	3
1.1 <i>Pictographs used in these instructions.....</i>	<i>4</i>
2 Technical data	5
2.1 <i>Standards and application conditions.....</i>	<i>5</i>
2.2 <i>Ratings.....</i>	<i>6</i>
3 Installation	7
3.1 <i>Mechanical installation</i>	<i>7</i>
3.1.1 <i>Dimensions and mounting</i>	<i>7</i>
3.2 <i>Electrical installation</i>	<i>8</i>
3.2.1 <i>Installation according to EMC requirements</i>	<i>8</i>
3.2.2 <i>Fuses/cable cross-sections.....</i>	<i>8</i>
3.2.3 <i>Connection diagram</i>	<i>9</i>
3.2.4 <i>Control terminals.....</i>	<i>10</i>
4 Commissioning	11
4.1 <i>Parameter setting.....</i>	<i>11</i>
4.2 <i>Electronic programming module (EPM)</i>	<i>11</i>
4.3 <i>Parameter menu</i>	<i>12</i>
5 Troubleshooting and fault elimination	17



About these instructions

This documentation applies to the smd frequency inverter, and contains important technical data and describes installation, operation, and commissioning.

These instructions are only valid for smd frequency inverters with software rev 20 (see drive nameplate).

Please read the instructions before commissioning.

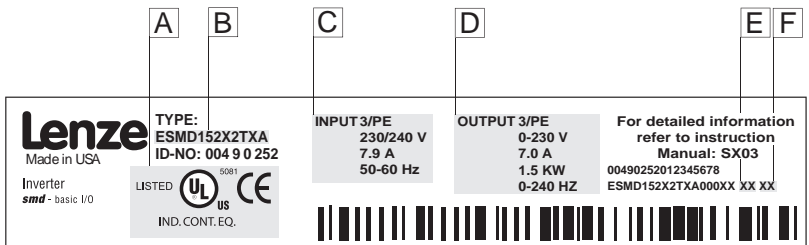

A Certifications

B Type

C Input Ratings

D Output Ratings

E Hardware Version

F Software Version

Scope of delivery	Important
<ul style="list-style-type: none"> 1 smd inverter (ESMD...) with EPM installed (see Section 4.2) 1 Operating Instructions 	<p>After receipt of the delivery, check immediately whether the items delivered match the accompanying papers. Lenze does not accept any liability for deficiencies claimed subsequently.</p> <p>Claim</p> <ul style="list-style-type: none"> visible transport damage immediately to the forwarder. visible deficiencies/incompleteness immediately to your Lenze representative.



1 Safety information

General

Some parts of Lenze controllers (frequency inverters, servo inverters, DC controllers) can be live, moving and rotating. Some surfaces can be hot.

Non-authorized removal of the required cover, inappropriate use, and incorrect installation or operation creates the risk of severe injury to personnel or damage to equipment.

All operations concerning transport, installation, and commissioning as well as maintenance must be carried out by qualified, skilled personnel (IEC 364 and CENELEC HD 384 or DIN VDE 0100 and IEC report 664 or DIN VDE0110 and national regulations for the prevention of accidents must be observed).

According to this basic safety information, qualified skilled personnel are persons who are familiar with the installation, assembly, commissioning, and operation of the product and who have the qualifications necessary for their occupation.

Application as directed

Drive controllers are components which are designed for installation in electrical systems or machinery. They are not to be used as appliances. They are intended exclusively for professional and commercial purposes according to EN 61000-3-2. The documentation includes information on compliance with the EN 61000-3-2.

When installing the drive controllers in machines, commissioning (i.e. the starting of operation as directed) is prohibited until it is proven that the machine complies with the regulations of the EC Directive 98/37/EC (Machinery Directive); EN 60204 must be observed.

Commissioning (i.e. starting of operation as directed) is only allowed when there is compliance with the EMC Directive (89/336/EEC).

The drive controllers meet the requirements of the Low Voltage Directive 73/23/EEC. The harmonised standards of the series EN 50178/DIN VDE 0160 apply to the controllers.

Note: The availability of controllers is restricted according to EN 61800-3. These products can cause radio interference in residential areas. In this case, special measures can be necessary.

Installation

Ensure proper handling and avoid excessive mechanical stress. Do not bend any components and do not change any insulation distances during transport or handling. Do not touch any electronic components and contacts.

Controllers contain electrostatically sensitive components, which can easily be damaged by inappropriate handling. Do not damage or destroy any electrical components since this might endanger your health!

Electrical connection

When working on live drive controllers, applicable national regulations for the prevention of accidents (e.g. VBG 4) must be observed.

The electrical installation must be carried out according to the appropriate regulations (e.g. cable cross-sections, fuses, PE connection). Additional information can be obtained from the documentation.

The documentation contains information about installation in compliance with EMC (shielding, grounding, filters and cables). These notes must also be observed for CE-marked controllers.

The manufacturer of the system or machine is responsible for compliance with the required limit values demanded by EMC legislation.



Safety information

Operation

Systems including controllers must be equipped with additional monitoring and protection devices according to the corresponding standards (e.g. technical equipment, regulations for prevention of accidents, etc.). You are allowed to adapt the controller to your application as described in the documentation.



DANGER!

- After the controller has been disconnected from the supply voltage, live components and power connection must not be touched immediately, since capacitors could be charged. Please observe the corresponding notes on the controller.
- Do not continuously cycle input power to the controller more than once every three minutes.
- Please close all protective covers and doors during operation.

Note for UL approved system with integrated controllers

UL warnings are notes which apply to UL systems. The documentation contains special information about UL.



Warnings!

- Suitable for use on a circuit capable of delivering not more than 5000 rms symmetrical amperes, 240 V maximum (240 V devices) or 500 V maximum (400/500 V devices) respectively
- Use minimum 75 °C copper wire only.
- Shall be installed in a pollution degree 2 macro-environment.

1.1 Pictographs used in these instructions

Pictograph	Signal word	Meaning	Consequences if ignored
	DANGER!	Warning of Hazardous Electrical Voltage.	Reference to an imminent danger that may result in death or serious personal injury if the corresponding measures are not taken.
	WARNING!	Impending or possible danger for persons	Death or injury
	STOP!	Possible damage to equipment	Damage to drive system or its surroundings
	Note	Useful tip: If observed, it will make using the drive easier	



2 Technical data

2.1 Standards and application conditions

Conformity	CE Low Voltage Directive (73/23/EEC)	
Approvals	UL 508C Underwriters Laboratories - Power Conversion Equipment	
Max. permissible motor cable length ⁽¹⁾	shielded:	50 m (low-capacitance)
	unshielded:	100 m
Input voltage phase imbalance	≤ 2%	
Humidity	≤ 95% non-condensing	
Output frequency	0...500 Hz	
Environmental conditions	Class 3K3 to EN 50178	
Temperature range	Transport	-25 ... +70 °C
	Storage	-20 ... +70 °C
	Operation	0 ... +55 °C (with 2.5 %/°C current derating above +40 °C)
Installation height	0 ... 4000 m a.m.s.l. (with 5 %/1000 m current derating above 1000 m a.m.s.l.)	
Vibration resistance	acceleration resistant up to 0.7 g 10... 150Hz	
⚠ Earth leakage current	> 3.5 mA to PE	
Enclosure (EN 60529)	IP 20	
Protection measures against	short circuit, earth fault, overvoltage, motor stalling, motor overload	
Operation in public supply networks (Limitation of harmonic currents according to EN 61000-3-2)	Total power connected to the mains	Compliance with the requirements ⁽²⁾
	< 0.5 kW	With mains choke
	0.5 ... 1 kW	With active filter (in preparation)
	> 1 kW	Without additional measures

(1) For compliance with EMC regulations, the permissible cable lengths may change.

(2) The additional measures described only ensure that the controllers meet the requirements of the EN 61000-3-2. The machine/system manufacturer is responsible for the compliance with the regulations of the machine!



Technical data

2.2 Ratings

Type	Power [kW]	Mains		Output Current			
		Voltage, frequency	Current [A]	I _r		I _{max} for 60 s	
				[A] ⁽¹⁾	[A] ⁽²⁾	[A] ⁽¹⁾	[A] ⁽²⁾
ESMD251X2SFA	0.25	1/N/PE 230/240 V 2/PE 230/240 V (180 V - 0% ... 264 V + 0 %) 50/60 Hz (48 Hz - 0 % ... 62 Hz + 0 %)	3.4	1.7	1.6	2.6	2.4
ESMD371X2SFA	0.37		5.0	2.4	2.2	3.6	3.3
ESMD551X2SFA	0.55		6.0	3.0	2.8	4.5	4.2
ESMD751X2SFA	0.75		9.0	4.0	3.7	6.0	5.5
ESMD152X2SFA	1.5		14.0	7.0	6.4	10.5	9.6
ESMD222X2SFA	2.2		21.0	9.5	8.7	14.3	13.1
ESMD371X2TXA	0.37	3/PE 230/240 V (180 V - 0% ... 264 V + 0 %) 50/60 Hz (48 Hz - 0 % ... 62 Hz + 0 %)	2.7	2.4	2.2	3.6	3.3
ESMD751X2TXA	0.75		5.1	4.2	3.9	6.3	5.9
ESMD112X2TXA	1.1		6.9	6.0	5.5	9.0	8.3
ESMD152X2TXA	1.5		7.9	7.0	6.4	10.5	9.6
ESMD222X2TXA	2.2		11.0	9.6	8.8	14.4	13.2
ESMD302X2TXA	3.0		13.5	12.0	11.0	18.0	16.5
ESMD402X2TXA	4.0	17.1	15.2	14.0	22.8	21.0	

(1) For rated mains voltage and carrier frequencies 4, 6, 8 kHz

(2) For rated mains voltage and carrier frequency 10 kHz

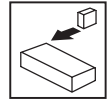

3 Installation

3.1 Mechanical installation

3.1.1 Dimensions and mounting

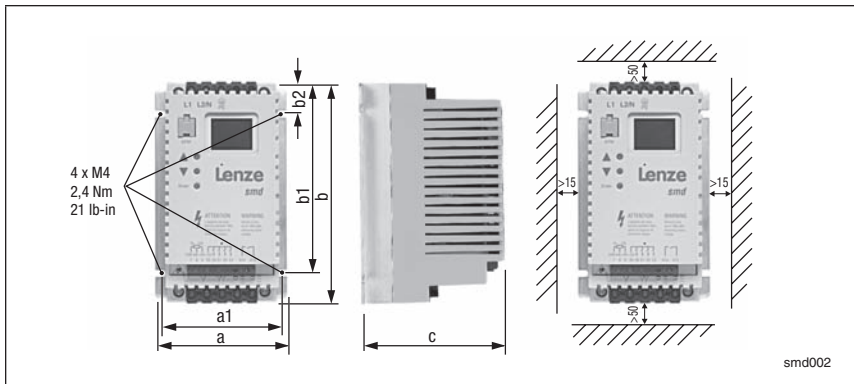

Type	a [mm]	a1 [mm]	b [mm]	b1 [mm]	b2 [mm]	c [mm]	m [kg]
ESMD251X2SFA	93	84	146	128	17	83	0.5
ESMD371X2SFA							
ESMD551X2SFA							
ESMD751X2SFA	93	84	146	128	17	92	0.6
ESMD152X2SFA	114	105	146	128	17	124	1.2
ESMD222X2SFA	114	105	146	128	17	140	1.4
ESMD371X2TXA	93	84	146	128	17	83	0.5
ESMD751X2TXA	93	84	146	128	17	92	0.6
ESMD112X2TXA	93	84	146	128	17	141	1.2
ESMD152X2TXA							
ESMD222X2TXA	114	105	146	128	17	140	1.4
ESMD302X2TXA	114	105	146	128	17	171	1.9
ESMD402X2TXA	114	105	146	100	17	171	1.7



WARNING!

Drives must not be installed where subjected to adverse environmental conditions such as: combustible, oily, or hazardous vapors or dust; excessive moisture; excessive vibration or excessive temperatures. Contact Lenze for more information.

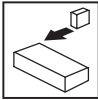

Installation

3.2 Electrical installation

3.2.1 Installation according to EMC requirements

<p>EMC Compliance with EN 61800-3/A11</p>	
<p>Noise emission Compliance with limit value class A according to EN 55011 if installed in a control cabinet with the appropriate footprint filter and the motor cable length does not exceed 10m</p>	
<p>[A] Screen clamps [B] Control cable [C] Low-capacitance motor cable (core/core ≤ 75 pF/m, core/screen ≤ 150 pF/m) [D] Electrically conductive mounting plate [E] Filter (if required)</p>	

Tmd005

3.2.2 Fuses/cable cross-sections⁽¹⁾

Type	Recommendations					E.i.c.b. ⁽²⁾
	Fuse	Miniature circuit breaker ⁽⁵⁾	Fuse ⁽³⁾ or Breaker ⁽⁶⁾ (N. America)	Input Power Wiring (L1, L2/N, L3, PE)		
				[mm ²]	[AWG]	
ESMD251X2SFA ... ESMD551X2SFA ESMD371X2TXA ... ESMD112X2TXA	M10 A	C10 A	10 A	2.5	14	≥ 30 mA
ESMD152X2TXA	M16 A	C16 A	12 A	2.5	14	
ESMD751X2SFA, ESMD222X2TXA	M16 A	C16 A	15 A	2.5	14	
ESMD152X2SFA, ESMD302X2TXA	M20 A	C20 A	20 A	4 ⁽⁴⁾	12	
ESMD222X2SFA, ESMD402X2TXA	M25 A	C25 A	25 A	6 ⁽⁴⁾	10	

- (1) Observe the applicable local regulations.
- (2) Pulse-current or universal-current sensitive earth leakage circuit breaker.
- (3) UL Class CC or T fast-acting current-limiting type fuses, 200,000 AIC, required. Bussman KTK-R, JJJ, JJS or equivalent.
- (4) Connection without end ferrules or with attached pin end connectors.
- (5) Installations with high fault current due to large supply mains may require a type D circuit breaker.
- (6) Thermomagnetic type breakers preferred.

Observe the following when using E.i.c.b:

- Installation of E.i.c.b only between supplying mains and controller.
- The E.i.c.b can be activated by:
 - capacitive leakage currents between the cable screens during operation (especially with long, screened motor cables)
 - connecting several controllers to the mains at the same time
 - RFI filters

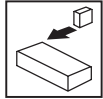

3.2.3 Connection diagram

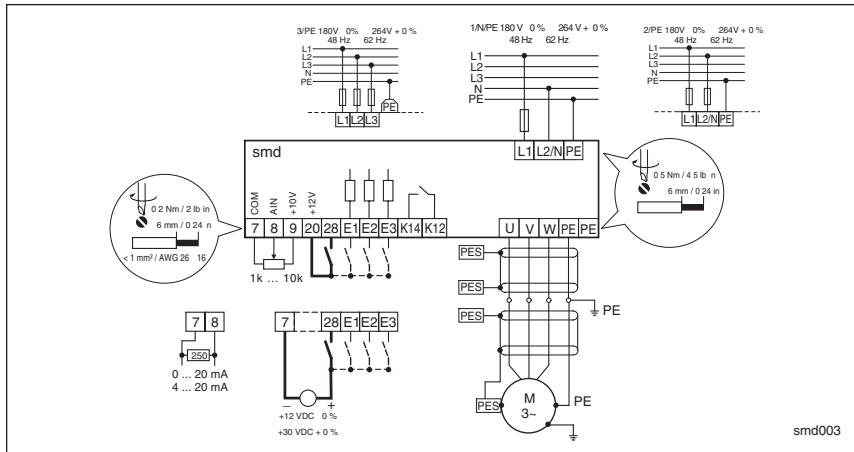

DANGER!

- Hazard of electrical shock! Circuit potentials are up to 240 VAC above earth ground. Capacitors retain charge after power is removed. Disconnect power and wait until the voltage between B+ and B- is 0 VDC before servicing the drive.
- Do not connect mains power to the output terminals (U,V,W)! Severe damage to the drive will result.
- Do not cycle mains power more than once every three minutes. Damage to the drive will result.

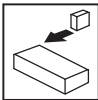

Installation

3.2.4 Control terminals

Terminal	Data for control connections (printed in bold = Lenze setting)	
7	Reference potential	
8	Analog input 0 ... 10 V (changeable under C34)	input resistance: >50 kΩ (with current signal: 250 Ω)
9	Internal DC supply for setpoint potentiometer	+10 V, max. 10 mA
20	Internal DC supply for digital inputs	+12 V, max. 20 mA
28	Digital input Start/Stop	LOW = Stop HIGH = Run Enable
E1	Digital input configurable with CE1 Activate fixed setpoint 1 (JOG1)	HIGH = JOG1 active
E2	Digital input configurable with CE2 Direction of rotation	LOW = CW rotation HIGH = CCW rotation
E3	Digital input configurable with CE3 Activate DC injection brake (DCB)	HIGH = DCB active
K12	Relay output (normally-open contact) configurable with C08	AC 250 V / 3 A DC 24 V / 2 A ... 240 V / 0.22 A
K14	Fault (TRIP)	

R_F = 3.3 kΩ



Note

LOW = 0 to +3V, HIGH = +12 to +30V.

Protection against contact

- All terminals have basic isolation (single insulating distance)
- Protection against contact can only be ensured by additional measures i.e. double insulation



4 Commissioning

4.1 Parameter setting

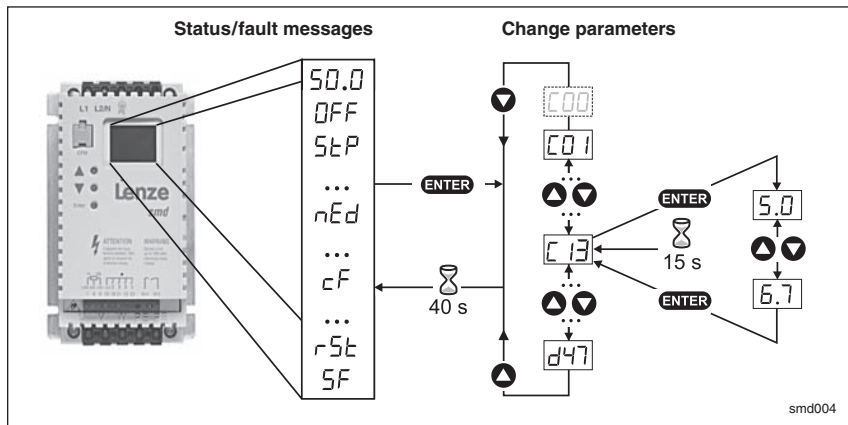

Note

If the password function is enabled, the password must be entered into C00 to access the parameters. C00 will not appear unless the password function is enabled. See C94.

4.2 Electronic programming module (EPM)

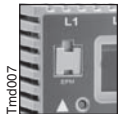

The EPM contains the controller's memory. Whenever parameter settings are changed, the values are stored in the EPM. It can be removed, but must be installed for the controller to operate (a missing EPM will trigger an *F 1* fault). The controller ships with protective tape over the EPM that can be removed after installation.

An optional EPM Programmer (EEP1RA) is available that allows: the controller to be programmed without power; OEM settings to be default settings; fast copying of EPMs when multiple controllers require identical settings. It can also store up to 60 custom parameter files for even faster controller programming.



Commissioning

4.3 Parameter menu

Code		Possible Settings		IMPORTANT	
No.	Name	Lenze	Selection		
C00	Password entry	0	0 999	Visible only when password is active (see C94)	
C01	Setpoint source	0	Analog input (terminal 8; see C34)	Observe notes about c40	
		1	Code c40		
C02	Load Lenze setting	0	No action/loading complete	<ul style="list-style-type: none"> • C02 = 1... 4 only possible with OFF • C02 = 2 : C11, C15 = 60 Hz 	
		1	Load 50 Hz Lenze settings		
		2	Load 60 Hz Lenze settings		
		3	Load OEM settings		
		4	Translate		
		WARNING! C02 = 1... 3 overwrites all settings! TRIP circuitry may be disabled! Check codes CE1...CE3.			
		NOTE If an EPM that contains data from a previous software version is installed, C02 = 4 converts the data to the current version.			
CE1	Configuration - Digital Input E1	1	1	Activate fixed setpoint 1 (JOG1)	<ul style="list-style-type: none"> • Use C37...C39 to adjust fixed setpoints • Activate JOG3: Both terminals = HIGH See also C36 LOW = CW rotation HIGH = CCW rotation Controlled deceleration to standstill, active LOW; Set decel rate in C13 or c03
			2	Activate fixed setpoint 2 (JOG2)	
			3	DC braking (DCB)	
			4	Direction of rotation	
			5	Quick stop	
			6	CW rotation	
CE2	Configuration - Digital Input E2	4	7	CCW rotation	CW rotation = LOW and CCW rotation = LOW: Quick stop; Open-circuit protected UP = LOW and DOWN = LOW: Quick stop; Use momentary NC contacts Active LOW, triggers EEr (motor coasts to standstill) NOTE: NC thermal contact from the motor can be used to trigger this input
			8	UP (setpoint ramp-up)	
			9	DOWN (setpoint ramp-down)	
			10	TRIP set	
CE3	Configuration - Digital Input E3	3	11	TRIP reset	See also c70 See c01 and c03 Disables PI function for manual control <ul style="list-style-type: none"> • Use C37...C39 to adjust fixed setpoints • Activate fixed PI setpoint 3: Both terminals = HIGH
			12	Accel/decel 2	
			13	Deactivate PI	
			14	Activate fixed PI setpoint 1	
			15	Activate fixed PI setpoint 2	

Commissioning



Code		Possible Settings			IMPORTANT
No.	Name	Lenze	Selection		
C08	Configuration - Relay output	1	Relay is energized if 0 Ready 1 Fault 2 Motor is running 3 Motor is running - CW rotation 4 Motor is running - CCW rotation 5 Output frequency = 0 Hz 6 Frequency setpoint reached 7 Threshold (C17) exceeded 8 Current limit (motor or generator mode) reached 9 Feedback within min/max alarm (d46, d47) range 10 Feedback outside min/max alarm (d46, d47) range		
C10	Minimum output frequency	0.0	0.0 {Hz}	500	<ul style="list-style-type: none"> Output frequency at 0% analog setpoint C10 not active for fixed setpoints or setpoint selection via c40
C11	Maximum output frequency	50.0	7.5 {Hz}	500	<ul style="list-style-type: none"> Output frequency at 100% analog setpoint C11 is never exceeded
		WARNING! Consult motor/machine manufacturer before operating above rated frequency. Overspeeding the motor/machine may cause damage to equipment and injury to personnel!			
C12	Acceleration time 1	5.0	0.0 {s}	999	<ul style="list-style-type: none"> C12 = frequency change 0 Hz...C11 C13 = frequency change C11...0 Hz For S-ramp accel/decel, adjust c82
C13	Deceleration time 1	5.0	0.0 {s}	999	
C14	Operating Mode	2	0 Linear characteristic with Auto-Boost		<ul style="list-style-type: none"> Linear characteristic: for standard applications Square-law characteristic: for fans and pumps with square-law load characteristic Auto boost: load-dependent output voltage for low-loss operation
			1 Square-law characteristic with Auto-Boost		
			2 Linear characteristic with constant V_{min} boost		
			3 Square-law characteristic with constant V_{min} boost		
C15	V/f reference point	50.0	25.0 {Hz}	999	
C16	V_{min} boost (optimization of torque behavior)	6.0	0.0 (%)	40.0	
		Set the rated motor frequency (nameplate) for standard applications			
		Set after commissioning: The unloaded motor should run at slip frequency (approx. 5 Hz), increase C16 until motor current (C54) = 0.8 x rated motor current			
C17	Frequency threshold (Q_{min})	0.0	0.0 {Hz}	500	See C08, selection 7 Reference: setpoint



Commissioning

Code		Possible Settings			IMPORTANT
No.	Name	Lenze	Selection		
C18	Chopper frequency	2	0 4 kHz 1 6 kHz 2 8 kHz 3 10 kHz		<ul style="list-style-type: none"> As chopper frequency is increased, motor noise is decreased Observe derating in Section 2.2 Automatic derating to 4 kHz at 1.2 x I_r
C21	Slip compensation	0.0	0.0 (%)	40.0	Change C21 until the motor speed no longer changes between no load and maximum load
C22	Current limit	150	30 (%)	150	<ul style="list-style-type: none"> When the limit value is reached, either the acceleration time increases or the output frequency decreases
			Reference: smd rated output current		
C24	Accel boost	0.0	0.0 (%)	20.0	Accel boost is only active during acceleration
C31	Analog input dead band	0	0 Enabled 1 Disabled		C31 = 0 activates dead band for analog input. When analog signal is within dead band, controller's output = 0.0 Hz and display will read 5tP
C34	Configuration - analog input	0	0 0...10 V 1 0...5 V 2 0...20 mA 3 4...20 mA 4 4...20 mA monitored		Will trigger 5d5 fault if signal falls below 2 mA
C36	Voltage - DC injection brake (DCB)	4.0	0.0 (%)	50.0	<ul style="list-style-type: none"> See CE1...CE3 and c06 Confirm motor suitability for use with DC braking
C37	Fixed setpoint 1 (JOG 1)	20.0	0.0 {Hz}	999	When PI is active (see d38), C37...C39 are fixed PI setpoints
C38	Fixed setpoint 2 (JOG 2)	30.0	0.0 {Hz}	999	
C39	Fixed setpoint 3 (JOG 3)	40.0	0.0 {Hz}	999	
C46	Frequency setpoint		0.0 {Hz}	500	Display: Setpoint via analog input, function UP/DOWN
C50	Output frequency		0.0 {Hz}	500	Display
C53	DC bus voltage		0.0 (%)	255	Display
C54	Motor current		0.0 (%)	255	Display
C59	PI feedback		c86 (%)	c87	Display
C70	Proportional gain	5.0	0.0 (%)	99.9	
C71	Integral gain	0.0	0.0 {s}	99.9	
C94	User password	0	0 Changing from "0" (no password), value will start at 763	999	When set to a value other than 0, must enter password at C00 to access parameters
C99	Software version				Display, format: x.yz

Commissioning



Code		Possible Settings				IMPORTANT
No.	Name	Lenze	Selection			
c01	Acceleration time 2	5.0	0.0	{s}	999	<ul style="list-style-type: none"> Activated using CE1...CE3 c01 = frequency change 0 Hz...C11 c03 = frequency change C11...0 Hz For S-ramp accel/decel, adjust c82
c03	Deceleration time 2	5.0	0.0	{s}	999	
c06	Holding time - automatic DC injection brake (Auto-DCB)	0.0	0.0	{s}	999	<ul style="list-style-type: none"> Automatic motor braking below 0.1 Hz by means of motor DC current for the entire holding time (afterwards: U, V, W inhibited) Confirm motor suitability for use with DC braking
			0.0 = not active 999 = continuous brake			
c20	I ² t switch-off (thermal motor monitoring)	100	30	{%}	100	<ul style="list-style-type: none"> Triggers OC6 fault when motor current exceeds c20 for too long <p>c20 = motor current rating x 100 smd output rating Example: if motor = 6.4amps and smd = 7.0amps, then c20 = 91%</p>
			100% = smd rated output current			
		WARNING! Maximum setting is rated motor current (see nameplate). Does not provide full motor protection!				
c38	Actual PI setpoint		c86		c87	Display
c40	Frequency setpoint via keys	0.0	0.0	{Hz}	500	Only active if C01 = 1
c42	Start condition (with mains on)	1	0 Start after LOW-HIGH change at terminal 28			See also c70
			1 Auto start if terminal 28 = HIGH			
		WARNING! Automatic starting/restarting may cause damage to equipment and/or injury to personnel! Automatic starting/restarting should only be used on equipment that is inaccessible to personnel.				
c60	Mode selection for c61	0	0 Monitoring only			c60 = 1 allows the keys to adjust speed setpoint (c40) while monitoring c61
			1 Monitoring and editing			
c61	Present status/error		status/error message			<ul style="list-style-type: none"> Display Refer to Section 5 for explanation of status and error messages
c62	Last error		error message			
c63	Last error but one					
c70	Configuration TRIP reset (error reset)	0	0 TRIP reset after LOW-HIGH change at terminal 28, mains switching, or after LOW-HIGH change at digital input "TRIP reset"			
			1 Auto-TRIP reset			
		WARNING! Automatic starting/restarting may cause damage to equipment and/or injury to personnel! Automatic starting/restarting should only be used on equipment that is inaccessible to personnel.				
		<ul style="list-style-type: none"> Auto-TRIP reset after the time set in c71 More than 8 errors in 10 minutes will trigger r5t fault 				



Commissioning

Code		Possible Settings				IMPORTANT
No.	Name	Lenze	Selection			
c71	Auto-TRIP reset delay	0.0	0.0	{s}	60.0	See c70
c78	Operating time counter		Display Total time in status "Start"			0...999 h: format xxx 1000...9999 h: format x.xx (x1000) 10000...99999 h: format xx.x (x1000)
c79	Mains connection time counter		Display Total time of mains = on			
c81	PI setpoint	0.0	c86		c87	
c82	S-ramp integration time	0.0	0.0	{s}	50.0	<ul style="list-style-type: none"> c82 = 0.0: Linear accel/decel ramp c82 > 0.0: Adjusts S-ramp curve for smoother ramp
c86	Minimum feedback	0.0	0.0		999	<ul style="list-style-type: none"> Select feedback signal at C34 If feedback is reverse-acting, set c86>c87
c87	Maximum feedback	100	0.0		999	
d25	PI setpoint accel/ decel	5.0	0.0	{s}	999	Sets rate of change for PI setpoint
d38	PI mode	0	0 PI disabled			When feedback (terminal 8) exceeds setpoint, speed decreases When feedback (terminal 8) exceeds setpoint, speed increases
			1 PI enabled: normal-acting			
			2 PI enabled: reverse-acting			
d46	Feedback minimum alarm	0.0	0.0		999	See C08, selections 9 and 10
d47	Feedback maximum alarm	0.0	0.0		999	

Troubleshooting and fault elimination



5 Troubleshooting and fault elimination

	Status	Cause	Remedy
e.g. SO.D	Present output frequency	Trouble free operation	
OFF	Stop (outputs U, V, W inhibited)	LOW signal at terminal 28	Set terminal 28 to HIGH
StP	Output frequency = 0 Hz (outputs U, V, W inhibited)	Setpoint = 0 Hz (C31 = 0)	Setpoint selection
		Quick stop activated through digital input	Deactivate Quick stop
br	DC-injection brake active	DC-injection brake activated <ul style="list-style-type: none"> • via digital input • automatically 	Deactivate DC-injection brake <ul style="list-style-type: none"> • digital input = LOW • automatically after holding time c06 has expired
CL	Current limit reached	Controllable overload	Automatically (see C22)
LU	Undervoltage on DC bus	Mains voltage too low	Check mains voltage
dEC	Overvoltage on DC bus during deceleration (warning)	Excessively short deceleration time (C13, c03)	Automatically if overvoltage < 1 s, OU , if overvoltage > 1 s
nEd	No access to code	Can only be changed when the controller is in OFF	Set terminal 28 to LOW

	Error	Cause	Remedy ⁽¹⁾
cF	Data on EPM not valid	Data not valid for controller	<ul style="list-style-type: none"> • Use EPM providing valid data • Load Lenze setting
CF		Data error	
GF		OEM data not valid	
F I	EPM error	EPM missing or defective	Power down and replace EPM
CFG	Digital inputs not uniquely assigned	E1...E3 assigned with the same digital signals	Each digital signal can only be used once
		Either just "UP" or "DOWN" used	Assign the missing digital signal to a second terminal
EEr	External error	Digital input "TRIP set" is active	Remove external error
F2...FD, JF	Internal fault		Please contact Lenze
LC	Automatic start inhibited	c42 = 0	LOW-HIGH signal change at terminal 28
DC I	Short-circuit or overload	Short-circuit	Find reason for short-circuit; check motor cable
		Excessive capacitive charging current of the motor cable	Use shorter motor cables with lower charging current
		Acceleration time (C12, c01) too short	<ul style="list-style-type: none"> • Increase acceleration time • Check controller selection
		Defective motor cable	Check wiring
		Internal fault in motor	Check motor
	Frequent and long overload	Check controller selection	

(1) The drive can only be restarted if the error message has been reset; see c70



Troubleshooting and fault elimination

	Error	Cause	Remedy ⁽¹⁾
OC2	Earth fault	Grounded motor phase	Check motor/motor cable
		Excessive capacitive charging current of the motor cable	Use shorter motor cables with lower charging current
OC6	Motor overload (I ² t overload)	Motor is thermally overloaded, due to: <ul style="list-style-type: none"> • impermissible continuous current • frequent or too long acceleration processes 	<ul style="list-style-type: none"> • Check controller selection • Check setting of c20
OH	Controller overtemperature	Controller too hot inside	<ul style="list-style-type: none"> • Reduce controller load • Improve cooling
OJ	Overvoltage on DC bus	Mains voltage too high	Check mains voltage
		Excessively short deceleration time or motor in generator mode	Increase deceleration time or use dynamic braking option
		Earth leakage on the motor side	Check motor/motor cable (separate motor from controller)
rSt	Faulty auto-TRIP reset	More than 8 errors in 10 minutes	Depends on the error
SdS	Loss of 4-20 mA reference	4-20 mA signal is below 2 mA (C34 = 4)	Check signal/signal wire
SF	Single phase fault	A mains phase has been lost	Check mains voltage

(1) The drive can only be restarted if the error message has been reset; see c70

Notes

Notizen

Nota





Notes

Notizen

Nota

SX03K-en1