

USER MANUAL

PROGRAMMABLE MOTION CONTROLLER

1 · 2-AXIS HIGH SPEED STAND-ALONE SERIES

1 · 2 – Axis High Speed Motion Controller (PMC – 1 HS/PMC – 2HS)

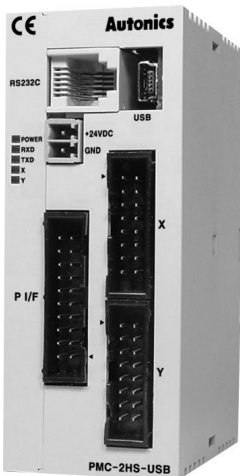

(It is optional.)



< PMC-HS Main features >

- Various algorithms by the combination of 12 commands
- Four drive functions
- Max. 4Mpps high-speed output pulse
- Parameter configuration function via a dedicated S/W
- 64 steps of Positioning/Speed determinant
- Separable teaching unit(PMC-2TU-232, it is optional.)
- Compatible with Windows 98, NT, 2000 and XP

Autonics

SENSOR & CONTROLLER

1. Introduction -----	3
1.1 Product Overview -----	3
1.2 Basic Composition of I/O Signal -----	3
1.3 Start the Drive -----	3
2. Program Installation -----	4
2.1 Installation of Operation Program -----	4
2.2 Uninstallation of Operation Program -----	5
2.3 Installation of USB Drive -----	5
2.3.1 Check the start of Operation Program -----	6
2.4 Connection of RS-232C -----	6
3. Configuration of the Operation Mode and System Parameters -----	7
3.1 Execution of Operation Program -----	7
3.2 Mode configuration -----	7
3.2.1 Limit Stop Mode and Limit Active Mode -----	8
3.2.2 Servo Inposition Enable and Servo Inposition level -----	8
3.2.3 Servo Alarm Enable and Servo Alarm Level -----	8
3.2.4 End Pulse -----	9
3.2.5 Selection of Deceleration Value -----	9
3.2.6 Software Limit -----	9
3.2.7 Power on Home Search Start -----	10
3.2.8 Power on Program Start -----	10
3.3 Configuration of Parameters -----	10
3.3.1 Speed Multiplier -----	11
3.3.2 Acceleration Rate -----	11
3.3.3 Deceleration Rate -----	11
3.3.4 Start Speed -----	11
3.3.5 Drive Speed 1~4 -----	12
3.3.6 Post Timer 1~31 -----	12
3.3.7 Home Search Low Speed -----	12
3.3.8 Home Search High Speed -----	12
3.3.9 Home Search Offset -----	12
3.3.10 Software Limit + -----	13
3.3.11 Software Limit - -----	13
3.3.12 End Pulse Width -----	13
3.3.13 Pulse Scale Numerator -----	13
3.3.14 Pulse Scale Denominator -----	14
3.4 Configuration of Home Search Mode -----	14
3.4.1 Description of Home Search Operation -----	14
3.4.2 Step1: High Speed Near Home Search -----	14
3.4.3 Step2: Low Speed Home Search -----	14
3.4.4 Step3: Low Speed Z-phase Search -----	14
3.4.5 Step 4: High Speed Offset -----	15
3.4.6 Configuration of Home Search Mode -----	15
3.4.7 Near Home Signal Level (STOP0) -----	15
3.4.8 Home Signal Level (STOP1) -----	15
3.4.9 Z Signal level (STOP2) -----	16
3.4.10 Enable / Disable of Step 1~4 -----	16
3.4.11 Direction of Step 1~4 -----	16
3.4.12 Position Clear -----	16
3.4.13 Using Limit Signal -----	16
3.4.14 DCC Enable -----	16

Contents

3.4.15 DCC Level -----	17
3.4.16 DCC Width -----	17
3.4.17 Example of the Home Search Mode Configuration -----	17
3.4.17.1 Home Search Configuration by Home Signal -----	17
3.4.17.2 Home Search Configuration by Limit Signal -----	19
4. Configuration of Operation Program -----	21
4.1 Start of operation program -----	21
4.1.1 Commands of the Operation Program -----	22
4.1.2 I/O port numbers -----	25
4.2 Drive by Parallel P I/F(Parallel Interface) -----	25
4.2.1 Execution of Home Search -----	25
4.3 Index Drive -----	26
4.4 Scan Drive -----	27
4.5 Continuous drive -----	27
4.6 Program Drive -----	28
5. Drive by PC -----	28
5.1 Start of operation program -----	28
5.2 Main Screen -----	29
5.3 Parameter/Mode Screen -----	32
5.3.1 Mode Tab -----	32
5.3.2 Parameter Tab -----	33
5.3.3 Home Search Mode Tab -----	34
5.4 Program Edit Screen -----	35
5.5 I/O Signal Screen -----	36
5.6 Errors -----	37
6. Drive by a Teaching Unit -----	38
6.1 Operation of data edit -----	39
6.1.1 Register Selection -----	39
6.1.2 Register Composition -----	39
6.1.3 Input of Operation Program -----	40
6.1.4 Input of Operation Mode and Parameters -----	41
6.1.5 Index Drive -----	43
6.2 Operation of drive -----	43
6.2.1 Home Search -----	43
6.2.2 JOG Operation -----	43
6.2.3 Execution of Operation Program -----	44
6.2.4 Record of Current Position -----	44
7. Product Specifications and I/O Signal Connection -----	45
7.1 Product Specifications -----	45
7.2 Connector Types and I/O Signal Connection -----	47
7.2.1 CN1 : Power Connector -----	47
7.2.2 CN2 : RS-232C Serial I/F Connector -----	47
7.2.3 CN3 : Parallel P I/F Connector -----	48
7.2.4 CN4, CN5 : I/O Connector -----	51
8. Serial Communication Commands -----	53
8.1 Communication Condition -----	53
8.2 Message Description -----	53
[Data] Reading and Writing of Parameter/Mode Values -----	62

■ Cautions for Safety

* 'Safety cautions' must be observed in order to avoid potential hazards that could result in personal injuries or damage to your product by using the product safely and correctly.	
* The safety cautions have been classified into 'Warning' and 'Caution', and they have the meanings as shown below.	
⚠ Warning	Indicates the existence of a hazard that could result in death or serious bodily injury if the safety instruction is not observed.
⚠ Caution	Indicates the existence of a hazard that could result minor bodily injury or damage to the product if the safety instruction is not observed.
* The meaning of the icon used in the product and the manual are as follows: ⚠ This icon indicates the existence of a hazard in a specific environment.	

- * This manual offers important information, read carefully and follows the instructions.
 After reading this guide, please keep in the place that you can reach easily.

● Use of the product

⚠ Warning

- 1. Use only after attaching doubled safety device for instruments that have big effect for human body and property, such as Atomic energy devices, Medical implements, vehicles, Rails, Aircrafts, Burners or Safety products.**
 Non-compliance may cause fire, personal injury or damage to property.
- 2. For the safe operation of entirely system regardless of external power failure and controller trouble, prepare the safety device in the external of the controller.**
 Non-compliance may result in fire, personal injury or damage to property.
- 3. Do not modify the product.**
 Non-compliance may cause electric shock, fire, personal injury or damage to property.

⚠ Caution

- 1. Use rectified power supply via insulation transformer for the input power.**
 Non-compliance may lead to fire, electric shock personal injury or damage to property.

● Installation of the product

⚠ Warning

- 1. Install a limit switch by all means.**
 Non-compliance may cause personal injury or damage to property.
- 2. Install with the plan for power failure.**
 Non-compliance may lead to personal injury or damage to property.
- 3. Use the product under the environment as described in the manual.**
Avoid from the place emitting corrosive gas, flammable gas, high temperature, high humidity, vibration or electromagnetic wave.
 Non-compliance may result in electric shock, wrong operation, damage to the product and performance deterioration.
- 4. Prevent metals from entering the vent of the controller.**
 Non-compliance may bring out fire, failure, wrong operation damage to the product and performance deterioration.
- 5. Fix the power and signal wiring to around the controller body and mount on a DIN rail or a panel.**
 Non-compliance may invite electric shock, fire, failure, wrong operation damage to the product and performance deterioration.
- 6. Confirm the power input specification and connect the power after checking the input terminal.**
 Non-compliance may lead to fire.

⚠ Caution

1. **Do not impose excessive power. The tightening torque of a connector is 0.4 Nm.**
The excessive power may cause the poor contact.
2. **Use the AWG28-16 line for the power line.**
Non-compliance may lead to the outbreak of fire.
3. **If a ribbon cable is used as the I/O line, connect the cable correctly and prevent from poor contact.**
The poor contact may cause wrong operation.
4. **Use a driver for M2 screw.**
Non-compliance may lead to damage of the connector screw.
5. **Connect after checking the connector specification and format.**
The use of wrong connector may cause fire, electric shock or damage to the product.
6. **Cut off the power when you install or connect lines.**
Non-compliance may result in electric shock or damage to the product.

●Use of the product**⚠ Warning**

1. **Do not wire, inspect or repair when the power is applied.**
Doing so may result in electric shock or wrong operation.
2. **Do not repair if you are not qualified.**
Doing so may result in electric shock or fire.
*For the repair, contact with us.
3. **Do not detach connectors during operation.**
Doing so may result in personal injury, damage to property or wrong operation.
4. **Do not cut off the power during operation.**
Doing so may result in personal injury, damage to property or wrong operation.
5. **Do not clean with water or organic solvents.**
Doing so may result in electric shock, fire.
6. **Please handle it as industrial waste for exhausting.**

⚠ Caution

1. **Use the product at the range of the range/performance.**
Non-compliance may decrease the life cycle and lead to fire.
2. **Note that each parameter should be configured within the limit of configuration value.**
3. **Prepare the emergency stop in operation.**
Non-compliance may result in damage to the product or personal injury.
4. **In wiring, possibly separate cables from the power line, the load line not to be affected by noise.**
The noise may lead to wrong operation and damage to product.

1. Introduce

1.1 Product Overview

PMC-HS series is a unit to determine the position or control the speed of a pulse input servo motor or a stepping motor. The built-in EEPROM can store operation parameters and maximum 64-program data per each axis. PMC-1HS is a 1-Axis motion controller and divided into PMC-1HS-232 and PMC-1HS-USB models, PMC-2HS is a 2-Axis motion controller and divided into PMC-2HS-232 and PMC-2HS-USB models. The 232 model is equipped with RS-232C interface and the USB model is equipped with RS-232C and USB interfaces.

Type (PMC-HS)	Control axis	Serial communication port
PMC-1HS-232	1	RS-232C
PMC-1HS-USB	1	RS-232C and USB
PMC-2HS-232	2	RS-232C
PMC-2HS-USB	2	RS-232C, USB Multiple use

This motion controller has maximum 4 MHz of adjustable speed drive pulse oscillator and a position counter. The drive pulse output come from a motor driver is line driver output. The motor driver of line receiver output can be connected to the photo coupler input. The sensor input is fully insulated by a photo-coupler and can [Input limit, Home search input, Servo inposition and Servo alarm].

The serial communication port has RS-232C and USB interface (in case of 232 types, RS-232C is only). The serial communication port can be connected to a PC or teaching unit (PMC-2TU-232, it is optional.) to configure operation parameter, mode, position data and program data.

In addition, a user can directly write a program using serial commands (Refer to 8).

The parallel interface can be used to start the drive, select a position and a program and connect sequencers and switches.

1.2 Basic Composition of I/O Signal

Connect the drive pulse signal of motion controller to motor driver and input from sensor to limit or home search terminal of each direction. It is possible to input the inposition signal or the alarm signal for a servo motor.

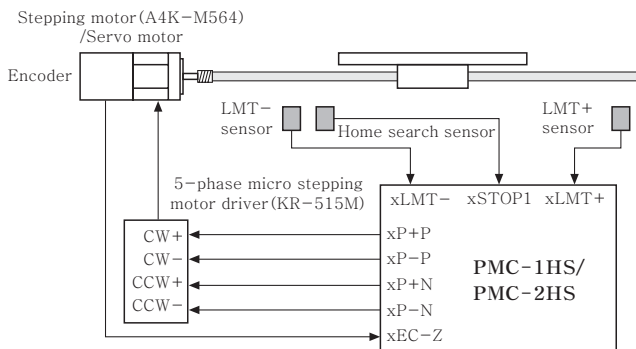

<Basic composition method of the motion controller (Configuration only for X-axis)>

1.3 Start the Drive

There are four ways to operate PMC-1HS/PMC-2HS.

- Start with a Parallel P I/F

Connect a sequence controller or a switch to the parallel P I/F. Refer to 4.2.

- Start with PC

Connect a PC and the controller body via a communication cable, starts the operation program and executes manual operation such as JOG output at each axis and home search output program.

Refer to chapter 5.

- Start with teaching unit (PMC-2TU-232)

Connect a communication cable annexed to a teaching unit (PMC-2TU-232).

It is available to execute JOG output, home output and programs by drive operation of teaching unit. Refer to chapter 6.

- Control by serial communication

The PMC-HS series provides serial communication commands (Refer to 8).

It is connected to a PC or a sequence controller via an USB cable or RS-232C communication cable and it can control axes by means of user's independent program.

2. Program Installation

2.1 Installation of Operation Program

- (1) Insert the CD given to a CD drive of a PC.

[Caution] Do not connect the PMC-HS body to the PC at this time. Even if the program can be installed in a connected status, OS starts to install the driver in the first connection if an USB cable is connected. In this case, install the operation program after installing the USB driver.

- (2) For Windows 98, ME and 2000

Windows 98 and ME ---- Run InstMsiA.exe in the InstMS folder.

Windows 2000-----Run InstMsiW.exe in the InstMS folder.

For Windows XP, additional installation is not required.

- (3) Double-click PMC.msi file on the Install folder.

- (4) Select the Next button to go to the following screen.

- (5) Select the desired folder and click the Next button to go to the following screen.

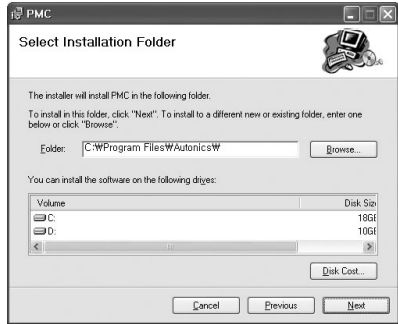
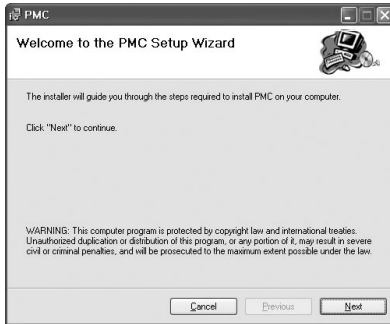

- (6) The progress of the installation is displayed.

- (7) The Installation Complete screen is displayed. Click the Close button to close the installer.

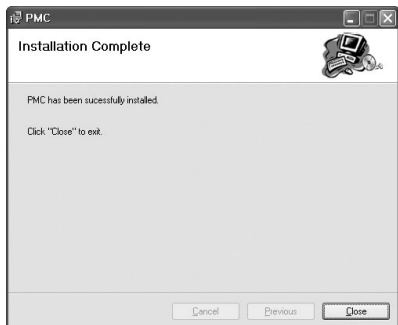
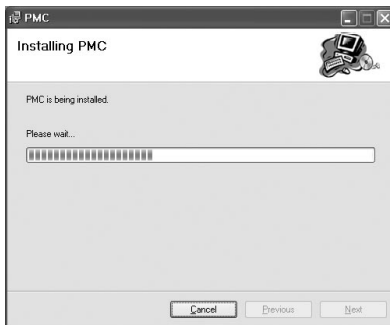

2.2 Uninstallation of Operation Program

The operation program needs to be removed to upgrade new version or to be deleted from a PC.

- (1) Uninstall this program with "Add/remove programs" in your Control Panel.
- (2) Click the "Remove" button after selecting "PMC" on the list of the screen.

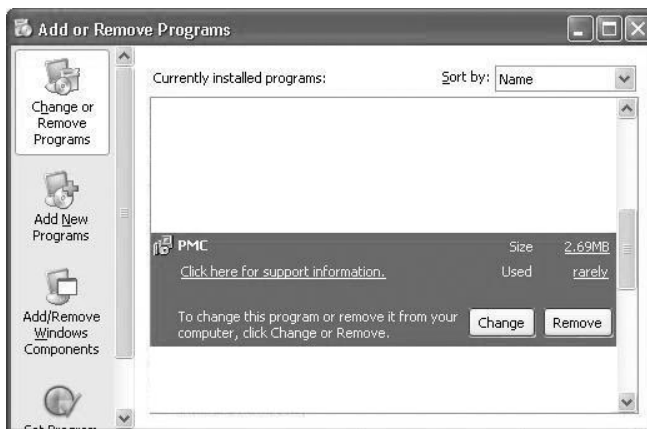

- (3) The operation program is uninstalled from the system.

2.3 Installation of USB Drive

Connect the motion controller to a PC via an USB communication cable and turn on the power supply. When the USB cable is connected first, new H/W is detected. Install the USB driver with the CD given. For Windows XP and 2000, the "PMC-HS/driver/xp2k" is specified.

For Windows 98 and ME, the "PMC-HS/driver/98me" is specified.

After installation, check the Device Manager as below.

Execute the My computer → Properties (Click right mouse button) → Hardware → Device Manager.

If "PMC-HS-USB Driver (Autonics Corp)" exists in universal serial BUS controller and "Autonics Serial port" exists in Port (COM and LPT), the USB driver was installed normally. (In case of Windows XP).

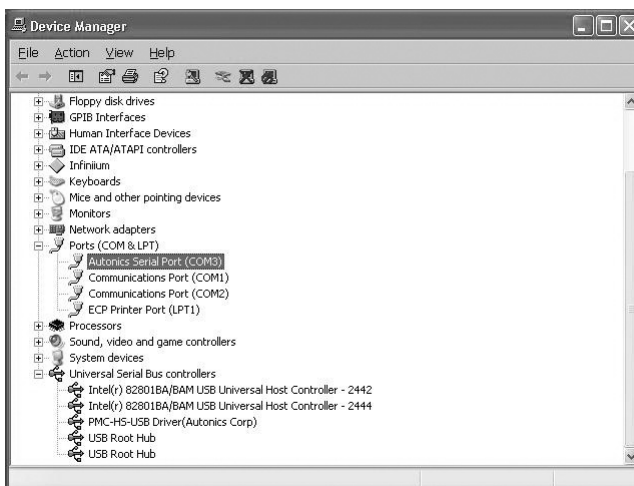

2.3.1 Check the starting of the operation Program

When you connect the motion controller, check the operation program is run correctly.

[Caution] When you start the operation program initially after installation, the program displays Offline even if the communication cable is connected. In this case, select the option menu on the main screen, mark the COM port is connected to the controller body and start the program again. In USB communication, if you select My Computer → Properties (click your right mouse button) → Hardware → Device Manager, you can check the COM port to be allocated next to "Prolific USB-to-Serial Comm Port" in Port (COM and LPT)

2.4 Connection of RS-232C

- (1) Connect the motion controller and a PC using RS-232C communication cable.
- (2) Turn on the motion controller and the PC.
- (3) Start the operation program by selecting the start button.
- (4) For initial access, the communication error message is popped up.

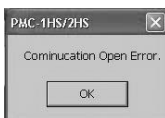

Check the OK button to display the communication error message.



Click the OK button.

- (5) Select your product type, PMC-2HS or PMC-1HS.

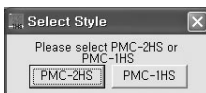

- (6) Start the operation program as off-line. Select Option and mark the COM port, the RS-232C communication cable is connected.

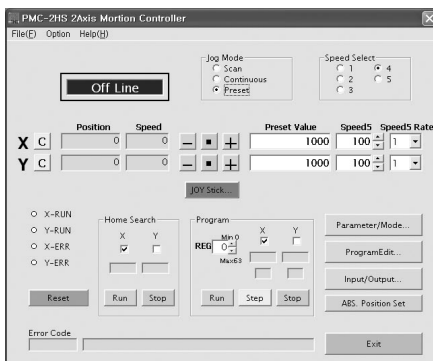

- (7) Restart the operation program. It will normally start in on-line mode.

3. Configuration of the Operating Mode and System Parameters

In order to operate PMC-1HS/PMC-2HS correctly, it is required to set operation mode • operation parameter of PMC-1HS/PMC-2HS suited with user system. For the configuration of the Operation Mode and System Parameters, connect PMC-1HS/2HS to the PC with RS232C communication cable or USB cable start the Windows operation program and then set them up on the Mode/Parameter screen.

The operating mode and the system parameters can be set by connecting a teaching unit to RS232C port of the motion controller. Refer to chapter 6 for the setup method with a teaching unit.

3.1 Execution of Operation Program

With a communication cable, connect PMC-1HS/PMC-2HS to your PC and start the operation program.

Click the Parameter/Mode button on the main screen to display the Parameter/Mode screen.

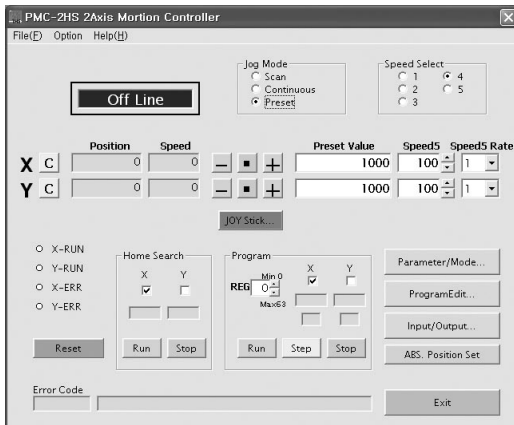

There are Mode, Parameter and Home Search Mode tabs on the Parameter/Mode screen. Set up value for each tab to meet the system requirement.

3.2 Configuration Mode

Click the mode tab to display the Mode screen. Only x axis is displayed for PMC-1HS.

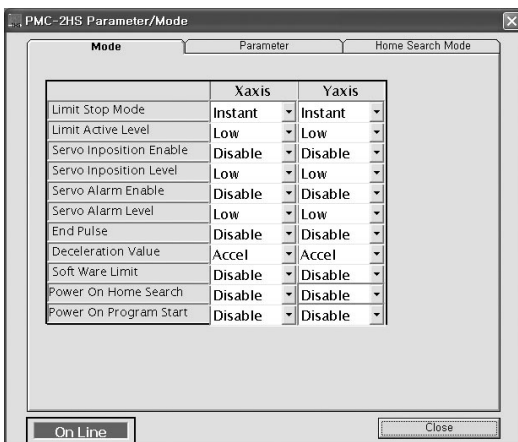

3.2.1 Limit Stop Mode and Limit Active Mode

When the Limit signal is activated, select the drive as Instant or Slow stop. In addition, specify the Limit Active level.

Display	Selection	Default value
Limit Stop Mode	Instant (Instant stop) / Slow (Slow stop)	Instant
Limit Active Level	Low (GEX connection) / High (Open)	Low

The Limit input signal(LMT+/-) in +/- direction of each axis enters to pin #12/#13 of CN4 and 5 connector(Refer 7.2.4).

When the Limit input signal is activated, the Limit Stop mode selects Instant or Slow stop of drive. In addition, the Limit Active Level specifies Low for GEX or High for open.

3.2.2 Servo Inposition Enable and Servo Inposition level

Select the operation for the Inposition signal from a servo motor driver.

Display	Selection	Default value
Servo Inposition Enable	Disable/ Enable	Disable
Servo Inposition Level	Low (GEX connection) / High (Open)	Low

The Inposition input signal (nINPOS) on each axis is pin #6 of CN4 and 5 connector(Refer 7.2.4).

When the Servo Inposition Enable is configured as Enable, after the drive comes out and the controller checks if nINPOS reaches to the active level and end, the drive. When the program is executed, after it executes drive commands(ABC and INC) and checks if nINPOS reaches to the active level and operates the next register.

The Servo Inposition Level configures whether nINPOS is activated in Open or GEX connection. It selects High if the nINPOS is activated in Open, otherwise it selects Low.

If a step motor is used or nINPOS is not used, the level is configured as the default value.

3.2.3 Servo Alarm Enable and Servo Alarm Level

Select an operation of alarm signal from a servo motor driver.

Display	Selection	Default value
Servo Alarm Enable	Disable/ Enable	Disable
Servo Alarm Level	Low (GEX connection) / High (Open)	Low

The Servo Alarm input signal (nALARM) on each axis is pin #7 of CN4 and 5 connector(Refer 7.2.4).

When the Servo Alarm is configured as Enable and the Servo Alarm signal (nALARM) of the drive is activated, the controller stops the drive output of the axis and makes the nERROR output signal ON.

The Servo Alarm Level configures whether nALARM is activated in OPEN or GEX connection.

It selects High if the nALARM is activated in Open, and it selects Low in GEX.

To cancel an error after error is occurred, it deactivates the nALARM and resets the controller.

If the nALARM is not used, the level is configured as the default value.

3.2.4 End Pulse

When the drive ends, output the End Pulse from nDRIVE/END signal of the parallel P I/F connector.

Display	Selection	Default value
End Pulse	Disable / Enable	Disable

The DRIVE/END output signal on each axis comes from pin #14 and 15 of the parallel P/I/F CN3.

When the End Pulse is configured as Disable, the nDRIVE/END signal outputs the ON pulse in driving or operating the program on each axis and returns to the Off state when the program is closed.

When the pulse is configured as Enable the signal is OFF in end pulse enable and specified ABS, INC index drive or home search and outputs the ON pulse as much as the time of end pulse width specified as a parameter. When ABS, INC and HOME commands are executed in operating the program, the signal outputs the ON pulse by the end pulse enable and the specified pulse width time.

3.2.5 Selection of Deceleration Value

Select the acceleration value (symmetry adjustable speed) or individual deceleration value (asymmetry adjustable speed) for the deceleration value of the trapezoid adjustable speed drive.

Display	Selection	Default value
Deceleration Value	Accel(Acceleration value)/Decel(Deceleration value)	Accel

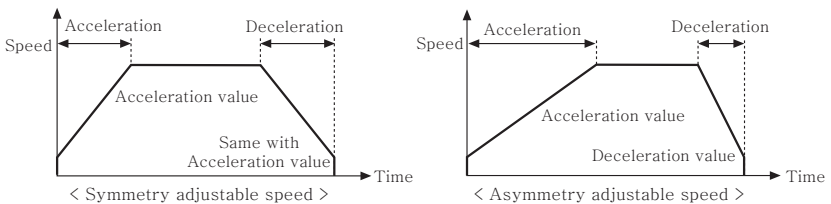

PMC-1HS/PMC-2HS can configure not only the symmetry adjustable speed drive that the acceleration value is the same with the deceleration value but also the asymmetry adjustable speed drive that the acceleration is different from the deceleration value. The selection of the acceleration value makes the parameter acceleration value as the deceleration value in deceleration so as to configure the symmetry adjustable drive or vice versa.

【Caution】 To configure the asymmetry adjustable speed drive, note the following cautions:

(1) Accel > Decel : The rate of the Accel and Decel must meet the following requirement.

For instance, if the drive speed, V is equal to 100kpps, the Decel (D) must be bigger than 1/40 of the Accel (A). Less than 1/40 of A for D is not allowed.

(2) Accel < Decel : As the rate of Accel and Decel is increased, PMC-1HS/PMC-2HS is accelerated so that it may be decelerated due to the shortage of pulse numbers.

3.2.6 Software Limit

Select Enable or Disable for the Software Limit.

Display	Selection	Default value
Software Limit	Disable/ Enable	Disable

The Software Limit is the overrun limit function that can be configured by internal position data apart from the mechanical limit signal input by means of external sensor. The Software Limit is selectively configured as the parameter values at the both of + and - directions. When it is enabled and exceeds the range of soft limit + or -, the controller is decelerated to stop. To cancel the software limit, drive the controller toward the reverse direction of the error.

【Reference】 Even if the Software Limit is enabled, the controller is not worked in operating the Home search command.

3.2.7 Power on Home Search Start

When the power is turned on, select Enable/Disable for the auto-start of home search.

Display	Selection	Default value
Power On Home Search Start	Disable / Enable	Disable

The Power on Home Search Start is the function to search home automatically when the power is turned on or the main body is reset.

3.2.8 Power on Program Start

When the power is turned on, select Enable/Disable for the auto-start of the program.

Display	Selection	Default value
Power On Program Start	Disable / Enable	Disable

The Power on Program Start is the function to execute the program configured as the start of the program register 00(REG00) when the power is turned on or the main body is reset. If the Power on Program Start is enabled, the program is automatically started after the completion of Home Search.

【Caution】

- (1) For the use of the Power on Program Start, let the next command be executed after the specified time by using the timer command (TIM) to REG00. In addition, it is recommended to configure the Home Search command for return-to-the origin to the program.
- (2) To cancel the Power on Program Start or the Power on Home Search Start, change the mode setup to Disable after stopping the operation (press the Stop key on the main screen).
Do not change the mode in operating.
- (3) Do not edit the program or change modes or parameters while the program is operated by the Power on Program Start. Change after the program is closed on the main screen (press the Stop key).

Warning

When the Power on Home Search Start is configured, note that the personnel injury may be resulted.

3.3. Configuration of Parameters

Click the Parameter tab to activate the Parameter screen. However, PMC-1HS only displays X axis.

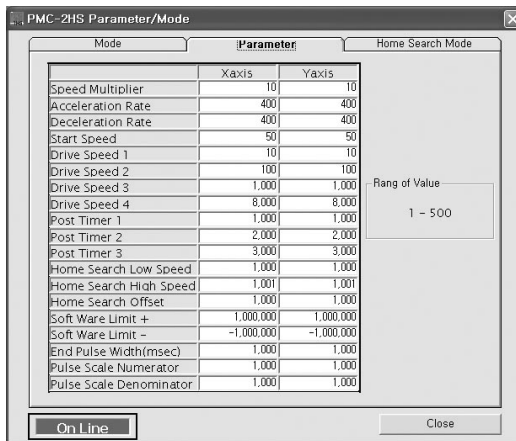

3.3.1 Speed Multiplier

The speed multiplier is a parameter to determine the multiplication of speed parameters such as drive speed and acceleration/deceleration values.

Display	Setting range	Default value
Speed multiplier	1 ~ 500	10

The speed parameters such as drive speed and acceleration/deceleration values are configurable between 1~8000. To use the value over the range, configure the speed multiplier appropriately.

When it makes the multiplication more bigger, enables to drive at high speed but the speed resolving power is decreasing. Configure to the minimum value to receive the range of the drive speed.

3.3.2 Acceleration Rate

The acceleration rate is a parameter is to be an acceleration speed when an adjustable speed drive accelerates. In mode setup, set the Deceleration Value to Accel(default value)use this Acceleration rate in drive deceleration.

Display	Setting range	Default value
Acceleration Rate	1 ~ 8000	400

$$\text{Acceleration Rate (pps)} = A \times 125 \times \text{Speed multiplier}$$

A is the Acceleration value configured.

To execute the adjustable speed drive, four speed parameters of start speed, drive speed, acceleration rate and deceleration rate must be configured. However, the deceleration rate does not need to be configured for the adjustable speed drive. For instance, if you want to start it at 0.3 seconds from the start speed 500pps to drive speed 20,000pps, configure the speed parameter as follows:

$$\text{Acceleration Rate (pps)} = (20,000 - 500) / 0.3 = 65,000 \text{ (pps)}$$

If the speed multiplier is set to 10 then,

$$\text{Acceleration value configured : } A = 65,000 / (125 \times 10) = 52$$

$$\text{Start speed value configured : } SV = 500 / 10 = 50$$

$$\text{Drive speed value configured : } V = 20,000 / 10 = 2,000$$

3.3.3 Deceleration Rate

The deceleration rate is a parameter is to be an acceleration speed when an adjustable speed drive accelerates.

Display	Setting range	Default value
Deceleration Rate	1 ~ 8000	400

$$\text{Deceleration Rate (pps)} = D \times 125 \times \text{Speed multiplier,}$$

D is the Deceleration value configured.

Since the default mode of the Deceleration Value is Accel, the acceleration value is used in deceleration and symmetry adjustable speed drive is operated. To operate asymmetry adjustable speed drive, configure the mode of the Deceleration Value as Decel.

3.3.4 Start Speed

The start speed means the speed when the adjustable speed drive starts or the end speed.

Display	Setting range	Default value
Start Speed	1 ~ 8000	50

The actual start speed is the value that is the start speed configuration value (SV) and the speed multiplier is multiplied.

$$\text{Start speed (pps)} = SV \times \text{Speed multiplier}$$

If the drive speed is bigger than the start speed, the adjustable speed speed drive is operated.

In this case, the parameter for the adjustable speed speed must be configured. If the drive speed is smaller than the start speed, the drive does not operate at adjustable speed speed but at constant speed from the first. Home Search High Speed is, also, operates in the same way.

3.3.5 Drive Speed 1~4

The drive speed is the speed for an adjustable speed drive.

Display	Setting range	Default value
Driver Speed 1	1 ~ 8000	10
Driver Speed 2	1 ~ 8000	100
Driver Speed 3	1 ~ 8000	1000
Driver Speed 4	1 ~ 8000	8000

Four-type drive speed for each axis is configured. For driving, one of four speeds is selected. The actual drive speed is the value that drive speed configuration value (V) and speed multiplier are multiplied.

$$\text{Drive speed(pps)} = V \times \text{Speed multiplier}$$

If the drive speed value is bigger than the start speed value, the drive operates at adjustable speed. In this case, the parameter for the adjustable speed must be configured. If the drive speed is smaller than the start speed, the drive does not operate at adjustable speed but at constant speed from the start.

3.3.6 Post Timer 1~3

The post timer is the waiting time to start next command after the execution of a drive command such as ABS or INC for program operation.

Display	Setting range	Default value
Post Timer 1	1 ~ 65535	10
Post Timer 2	1 ~ 65535	100
Post Timer 3	1 ~ 65535	1000

3.3.7 Home Search Low Speed

The home search low speed configures the search speed for step 2 and step 3 of Home Search.

Display	Setting range	Default value
Home Search Low Speed	1 ~ 8000	20

The actual drive speed is the value that the configuration value and speed multiplier are multiplied.
Home Search Low Speed (pps) = configuration value × Speed multiplier

[Caution] The Home Search Low Speed is configured as the value lower than the start speed.

3.3.8 Home Search High Speed

The home search high speed configures the search speed for step 1 and step 4 of Home Search.

Display	Setting range	Default value
Home Search High Speed	1 ~ 8000	1000

The actual drive speed is the value that the configuration value and speed multiplier are multiplied.
Home Search High Speed (pps) = configuration value × speed multiplier

Generally, The Home Search High Speed is configured as the value higher than the start speed.

3.3.9 Home Search Offset

The home search offset configures the amount of home search offset movement.

When the value is zero, the offset is not moves.

Display	Setting range	Default value
Home Search Offset	- 8388608 ~ + 8388607	+100

The configured value is related to numerator/denominator of pulse scale.

The above configuration range is the value when numerator/denominator of pulse scale=1000/1000.

3.3.10 Software Limit +

It configures the value of the software limit + direction.

Display	Setting range	Default value
Software Limit +	- 8388608 ~ +8388607	+8388607

The configured value is related to numerator/denominator of pulse scale.

The above configuration range is the value when numerator/denominator of pulse scale=1000/1000.

The software limit can be configurable by setting "Software Limit" in mode configuration to Enable.

For more information, refer to "Software Limit"(Refer to 3.2.6).

3.3.11 Software Limit -

It configures the value of the software limit + direction.

Display	Setting range	Default value
Software Limit -	- 8388608 ~ +8388607	-8388607

The configured value is related to numerator/denominator of pulse scale.

The above configuration range is the value when numerator/denominator of pulse scale=1000/1000.

The software limit can be configurable by setting "Software Limit" in mode configuration to Enable.

For more information, refer to "Software Limit"(Refer to 3.2.6).

3.3.12 End Pulse Width

When the drive ends, the end pulse width configures the pulse width of the end pulse coming from nDrive/END signal in mode configuration.

Display	Setting range	Default value
End Pulse Width(msec)	1~65535(msec)	100

The drive end pulse width function is configured by setting "Drive End Pulse" in mode configuration to Enable. For more information, refer to "Drive End Pulse" (Refer to 3.2.4).

3.3.13 Pulse Scale numerator

The pulse scale numerator is the numerator value to carry out scaling for position data.

Display	Setting range	Default value
Pulse Scale numerator	1 ~ 65535	1000

The pulse scale numerator function converts the position data which is entered or displayed into a pulse value. This function enables the position data to be handled as a value in mm or inch.

PMC-1HS/PMC-2HS converts the position data into a value by the following expression.

$$\text{Pulse value} = \text{Input value} \times \frac{\text{Numerator of pulse value}}{\text{Denominator of pulse value}}$$

$$\text{Displaying value} = \text{Pulse value} \times \frac{\text{Numerator of pulse value}}{\text{Denominator of pulse value}}$$

On the contrary, pulse values can be converted into position data.

For example, if one pulse of the drive pulse is corresponding to 0.1 mm of the moving amount, (Scale numerator) / (Scale denominator) is configured as 1/100 to execute the position display by mm.

When the input value of 1mm is entered, the value is converted into 100 pulses and displayed as 1.00.

If the operation result has decimal fraction, the displayed result round off to 1 pulse of the valid cipher.

The scaling position data is as follows:

Screen	Position data scaling
Main screen	Position, Preset value
Parameter screen	Home search offset, Software Limit +/-
Program edit screen	Position data of ABS, INC commands

【Caution】 Nominator and denominator of pulse scale affects to all position data. Configure under the environment using the step angle of motor rotation or ball screw pitch. Change the configuration value only after stopping your system. Since the default value of nominator/denominator of the pulse scale is 1000/1000, input and display is the same as pulse values.

3.3.14 Pulse Scale Denominator

The pulse scale denominator is the denominator value to carry out scaling for position data.

Display	Setting range	Default value
Pulse Scale denominator	1~65535	1000

3.4 Configuration of Home Search Mode

3.4.1 Description of Home Search Operation

The Home Search of PMC-1HS/PMC-2HS operates sequentially the step 1 to step 4 of the following table when the Home Search command is to be an Enable. It configures enable/disable, search direction and input signal level for each step. The step 1 and 4 start the search in Home search high speed configured as a parameter. In addition, the step 2 and 3 start the search in Home search low speed.

Step	Operation	Search speed	Detection signal
Step 1	High speed near home search	Home search high speed	nSTOP0
Step 2	Low speed home search	Home search low speed	nSTOP1
Step 3	Low speed encoder Z-phase search	Home search low speed	nSTOP2
Step 4	High speed offset movement	Home search high speed	-

3.4.2 Step 1 High Speed Near Home Search

Irregular operation

- ①Near home signal(nSTOP0) is activated before starting the step1. → Go to the step2.
- ②Limit signal of the detected direction is activated before starting the step1. → Go to the step2.
- ③Limit signal of the detected direction is activated in operating. → Stop the drive and go to the step2.

3.4.3 Step 2 Low Speed Home Search

The step 2 outputs the drive pulse to the Home search low speed in configured to the parameter and the specified direction until the home signal(nSTOP1) is activated. To execute the low speed search operation, the home search in low speed is configured as lower value than the start speed.

If the home signal(nSTOP1) is activated to the constant speed drive, the drive stops immediately.

Irregular operation

- ①The home signal(nSTOP1) is activated before starting the step2 → Move in the opposite direction of the specified detection searching home in low speed until the home signal(nSTOP1) is deactivated. When the home signal(nSTOP1) is deactivated, the step 2 starts.
- ②The limit signal of the detected direction is activated before starting the step 2 → Move in the opposite direction of the specified detection searching home in low speed until the home signal(nSTOP1) is activated. If the home signal(nSTOP1) is activated, PMC-1HS/PMC-2HS moves in the opposite direction of the specified detection searching home in low speed until the home signal(nSTOP1) is deactivated. When the home signal(nSTOP1) is deactivated, the step2 starts.
- ③The limit signal of the detected direction is activated in use. → Stop the drive and perform the same operation with ②.

3.4.4 Step 3 Low Speed Z-phase Search

The step3 outputs the drive pulse to the home search low speed is configured to the parameter and the specified direction until the encoder Z-phase signal(nSTOP2) is activated. To execute the low speed search operation, the home search in low speed is configured as lower value than the start speed.

If the encoder Z-phase signal(nSTOP2) is activated to the constant speed drive, the drive stops immediately. If the encoder Z-phase signal(nSTOP2) is activated in mode configuration, the deviation counter clear signal(also, as nOUT0 signal) can come out for a servo motor.

【Caution】

- ①If the encoder Z-phase signal(nSTOP2) has been already activated before the step3 starts, an error occurs and the home search ends. Adjust your system to start the step3 only when the encoder Z-phase signal(nSTOP2) is deactivated.
- ②If the limit signal of the detected direction has been already activated before the step3 starts, an error is occurred and the home search is ended.
- ③If the limit signal of the detected direction is activated in use, the detecting operation is stopped and the home search is ended.

3.4.5 Step 4 High Speed Offset

The step 4 outputs the drive pulses as many as the home search offset to the home search high speed is configured at the parameter and the specified direction. This is used to move from the mechanical home to working home. If the step 4 ends, the position counter is reset as zero(or Disable in mode configuration) and return to home.

3.4.6 Configuration of Home Search Mode

Activate the Mode screen by selecting the Home Search Mode tab. Only X-axis is displayed for PMC-1HS.

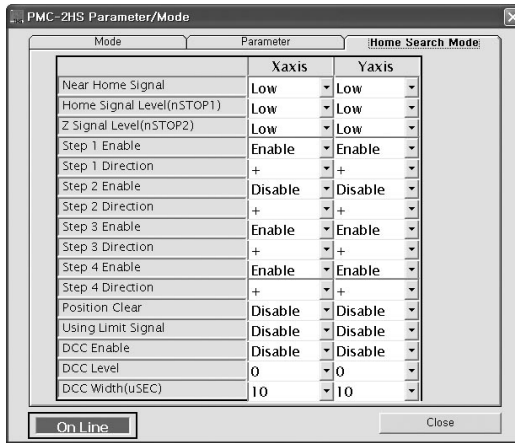

3.4.7 Near Home Signal Level(STOP0)

With the step 1, this mode configures the active level of the near home signal(nSTOP0).

Display	Selection	Default value
Near Home Signal Level(nSTOP0)	Low(GEX connection)/High(Open)	Low

Near home signal on each axis is pin #11 of connector CN4 and 5.

For the active level, in case of selecting Low, the detecting operation of the step 1 is started.

If the signal is connected to the GEX, the drive stops evaluating that the signal is active.

In case of High, the drive goes slow and stops evaluating that the opened signal is active.

3.4.8 Home Signal Level(STOP1)

With the step 1, this mode configures the active level of the home signal(nSTOP1).

Display	Selection	Default value
Home Signal Level (nSTOP1)	Low(GEX connection)/High(Open)	Low

Home signal on each axis is pin #10 of connector CN4 and 5.

For the active level, in case of selecting Low, the detecting operation of the step 2 started.

If the signal is connected to the GEX, the drive stops evaluating that the signal is active.

In case of High, the drive goes slow and stops evaluating that the opened signal is active.

3.4.9 Z Signal level(STOP2)

With the step 3, this mode configures the active level of the Encoder Z-phase signal(nSTOP0).

Display	Selection	Default value
Z Signal Level (nSTOP2)	Low(GEX connection)/High(Open)	Low

The encoder Z-phase signal (nSTOP2) of each axis is pin #9 of connector CN4 and 5.

For the active level, in case of selecting Low, the detecting operation of the step 3 starts.

If the signal is connected to the GEX, the drive stops evaluating that the signal is active. When high, the drive stops evaluating that the opened signal is active.

3.4.10 Enabling Step 1~4

This mode configures the Enable/Disable for each step.

Display	Selection	Default value
Step 1~4 Enable	Disable / Enable	Disable

If Disable is selected, the step is disabled and move to the next step.

If Enable is selected, the search operation of each step is carried in the specified direction. For the search operations, refer to 3.4.

3.4.11 Direction of Step 1~4 Direction

This mode configures the direction of each mode.

Display	Selection	Default value
Step1~4 Enable	+/-	Step 1, 2 : - Step 3, 4 : +

If + is configured, the drive pulse comes out to the + direction of the detection direction.

If - is configured, the drive pulse comes out in the - direction of the detection direction.

For the high speed offset movement of the step 4, the offset is moved in the configured direction when the home search offset of the parameter is +, or vice versa.

3.4.12 Clearing Position

When the home search ends, this mode clears the position counter.

Display	Selection	Default value
Position Clear	Disable / Enable	Enable

3.4.13 Using Limit Signal

It will be enabled when operates the home search with + direction of the limit signal or direction of the limit signal. Refer to 3.4 "The example to execute Home Search by only the limit signal."

Display	Selection	Default value
Using Limit Signal	Disable / Enable	Disable

3.4.14 Enabling DCC

In the operation of Auto Home Search step 3, if the encoder Z-phase is activated, deviation counter clear pulse is comes out.

Display	Selection	Default value
DCC Enable	Disable / Enable	Disable

The deviation counter clear pulse comes out from the output signal(pin #5) OUT0 of the connector CN4 or 5. If this mode is enabled, the OUT0 signal cannot be used as output for common output.

The DCC output is simultaneously activated with the Z-phase detection of the step 3 and the step 4 starts after the pulse output.

3.4.15 DCC Level

This mode specifies the level of the deviation counter clear pulse signal.

Display	Selection	Default value
DCC Level	0 (ON) / 1 (OFF)	0

0 : Since the output signal OUT0 is OFF in normal, the DCC pulse of ON comes out.

1 : Since the output signal OUT0 is ON in normal, the DCC pulse of OFF comes out.

Caution1 : The On state of the output signal OUT0 means that the output transistor of open collector becomes high.

Caution2 : Note that its active level is opposite with the OUT command of the operation program.

3.4.16 DCC Width

This mode configures the width of the deviation counter clear pulse output.

Display	Selection (μ sec)	Default value
DCC Width	10/20/100/200/1000/2000/10000/20000	10

Select one of 10/20/100/200/1000/2000/10000/2000 μ sec.

3.4.17 Example of the Home Search Mode Configuration

3.4.17.1 Home Search Configuration by Home Signal

High speed home search can be available by means of a home signal using both terminal of STOP0 and STOP1. The example is as follows:

[Operation]

	Input signal and active level	Detection direction	Detection speed
Step 1	STOP0 signal, Low (GEX connection)	- direction	20,000pps
Step 2	STOP0 signal, Low (GEX connection)	- direction	200pps
Step 3	Not operated		
Step 4	Offset movement of 34500 pulses in + direction	- direction	20,000pps

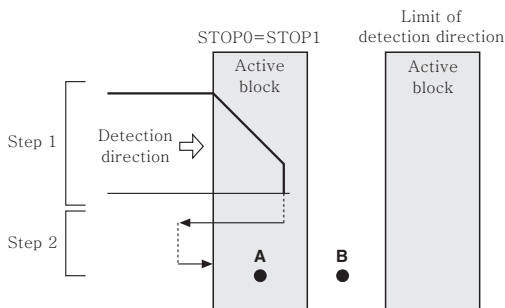

< Fig 1. Home search using the home signal >

Like Fig. 1, the step 1 and the step 2 have the same active level and the same detection direction. After the home search by step1 with high speed (20,000pps), when the home signal is activated, it starts to deceleration stop. The stop position is in an active block of the home signal, it escapes from the block in reverse by the irregular operation ① of the step 2 and enters, the operation of the step 2, detect the home. If the stop position of step 1 exceeds the active block of the home signal, the limit of the detection direction goes into the step 2, it will be the irregular operation of ③. If the start position of the home search is on A point, the step 1 is not operated and the irregular operation ② of the step 2 started. If it is on B point, the limit of the detection direction goes into the step 1, it starts the irregular operation ② of the step 2.

【 Caution 】

1. Build the overrun limit at the end of the detection direction to connect the signal to the limit input (LMT +/-).
2. Parameters configuration step 1 and step 2 at the same active level and the same detection direction since they use the same signal.

[Parameters configuration]

Item	Configuration value	Note
Speed Multiplier	10	
Acceleration Rate	400	Deceleration stop within the active block of the home signal
Start Speed	50	Start speed with trapezoid driving
Home Search Low Speed	20	Slower then the start speed of 200 pps
Home Search High Speed	2000	20,000pps
Home Search Offset	3500	

[Configuration of home search mode]

Item	Configuration value	Note
Near Home Signal Level(nSTOPO)	Low	Active by connecting GEX
Home Signal Level(nSTOP1)	Low	Identified signal with STOPO, so the level is the same with STOPO.
Z Signal Level(nSTOP2)	Low	Non-used
Step 1 Enable	Enable	Operation
Step 1 Direction	-	- direction
Step 2 Enable	Enable	Operation
Step 2 Direction	-	- direction
Step 3 Enable	Disable	No-operation
Step 3 Direction	-	
Step 4 Enable	Enable	Operation
Step 4 Direction	+	+ direction
Position Clear	Enable	Clear the position counter after searching home
Using Limit Signal	Disable	No-operation

Item	Configuration value	Note
DCC Enable	Disable	Disable
DCC Level	0	
DCC Width(μ sec)	10	

3.4.17.2 Home Search Configuration by Limit Signal

This is simple home search and the way the other side of the limit signal will serve as the home signal.

There are two conditions as the following:

- In case of high speed detection operation, the limit signal can be decelerated enough to stop within the distance to mechanical limit from the position that the signal is activated.
- The start position for the home search is within the active block of the limit signal.

The example that the limit signal of the - direction ins served as the home signal is as follows:

- Connect LMT- input to the input terminals of STOP0 and STOP1.
- Since the high speed search of step 1 is carried out, set the limit stop mode to the deceleration stop.
- Configure LMT-, STOP0, STOP1 signal levels identically.
- Enable the Using limit signal of the home search mode.
- Start the step 4 (offset movement), and end it after escaping the limit.

[Operation]

	Input signal and active level	Detection direction	Detection speed
Step 1	STOP0 signal, Low (GEX connection)	- direction	10,000pps
Step 2	STOP0 signal, Low (GEX connection)	- direction	200pps
Step 3	Disable		
Step 4	Offset movement of 500 pulses in + direction	+ direction	10,000pps

Step1 is moved to the limit in - direction in high speed. If LMT- signal is activated, the step1 decelerates to stop and changes into step2. It escapes the limit in reverse and stops after detecting the limit signal activated in low speed by the irregular operation ② of the step 2.

If the start position of the home search is in the limit (Fig. 1, A point), step 1 is not operated and step 2 starts. It reversely moves a certain position in step4 and ends escaping the limit.

[Caution]

1. Step 1 and Step 2 have the same direction.
2. Step 4 must be enabled and step1 and step2 are ended after escaping the limit in reverse.
3. Step 3 is entered in the opposite direction of step1 and step2.
4. Limit stop mode is set to the deceleration stop.

[Mode configuration]

Item	Configuration value	Note
Limit Stop Mode	Slow	Select the Deceleration stop
Limit Active Level	Low	

[Parameter configuration]

Item	Configuration value	Note
Speed Multiplier	10	
Acceleration Rate	400	Able to decelerate to stop within the active block of limit signal
Start Speed	50	Start speed of trapezoid drive
Home Search Low Speed	20	Slower than the start speed of 200 pps
Home Search High Speed	1000	10,000 pps
Home Search Offset	500	Required distance to escape the limit range

[Home Search Mode configuration]

Item	Configuration value	Note
Near Home Signal Level(nSTOP0)	Low	Since the limit signal is used, the level is same with the limit signal
Home Signal Level(nSTOP1)	Low	Since the limit signal is used, the level is same with the limit signal
Z Signal Level(nSTOP2)	Low	Not used
Step 1 Enable	Enable	Operation
Step 1 Direction	-	- direction
Step 2 Enable	Enable	Operation
Step 2 Direction	-	- direction
Step 3 Enable	Disable	Not operated
Step 3 Direction	-	
Step 4 Enable	Enable	Operation(escaping the limit)
Step 4 Direction	+	+ direction
Position Clear	Enable	Clear position counter after completing home search
Using Limit Signal	Enable	Use
DCC Enable	Disable	Not used
DCC Level	0	
DCC Width(μ sec)	10	

4. Configuration of Operation Program

PMC-1HS can configure the program with maximum 64 steps(REG0-63) on X-axis, while PMC-2HS can configure the program on X-axis or Y-axis. Since the program can execute from a random register number, it can write multiple programs in 64-register. Configure the operation program after you connect PMC-1HS/PMC-2HS to your PC using a RS232C communication cable or an USB cable, start the windows operation program and configure on the program edit screen. In addition, you can execute the teaching unit(PMC-2TU-232) of extra-cost option after connecting to RS232C port in the main body.

For the configuration of the teaching unit, refer to chapter 6.

The operation program can be available as the following three ways:

- ①Using the the operation program • the main screen on your PC
- ②Using a parallel P I/F
- ③Using a teaching unit

4.1 Starting the operation program

You can start the operation program after connecting PMC-1HS/PMC-2HS to your PC using a communication cable. (For the start of the operation program, refer to 3.1) Click the Program Edit button on the main screen. The Program edit screen is displayed.

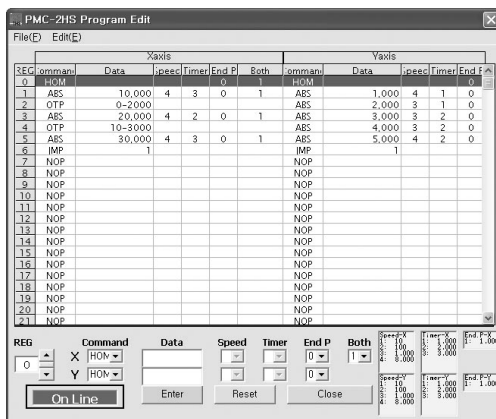
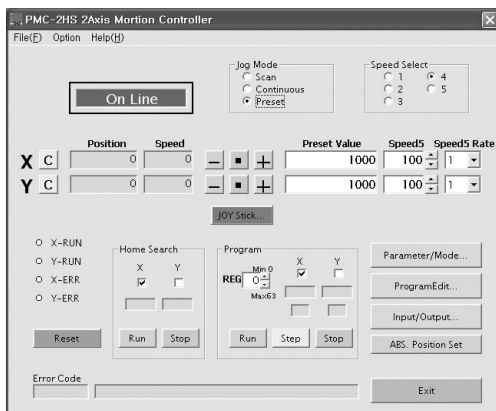

This paragraph only describes each command of the program. For the detailed handling of the program edit screen, refer to 5.4.

4.1.1 Commands in the Operation Program

The operation program has 12 commands as shown below.

Command type	Code	Description
Drive commands	ABS	Move absolute position
	INC	Move relative position
	HOM	Home search
I/O commands	IJP	Jump input condition
	OUT	On/Off of Output port
	OTP	ON pulse from output port
Program control commands	JMP	Jump
	REP	Start repetition
	RPE	End repetition
	END	End program
Others	TIM	Timer
	NOP	No operation

Now, each command is described as shown below.

■ ABS Move absolute position

CMD	Data	STD	TIM	END.P	Both
ABS	Absolute position(-8388608 ~ +8388607)	1~4	0~3	0/1	0/1

Move the specified distance on the basis of the home to absolute position.

- Data : Input the movement position to absolute value. This value can be configured in mm or inch if pulse nominator/denominator is configured (refer to 3.3). The default value is the pulse value since the nominator and denominator of pulse scale are equal.
The range of data configuration for pulse value is between -8388608 and +8388607.
- SPD : This value selects the drive speed in moving.
Drive speed 1~4 are the speeds registered in parameters configuration (Refer to 3.3).
- TIM : This value specifies the waiting time until the next register is executed after the movement is completed. If 1, 2 and 3 are specified at TIM, the time of the post timer 1 to 3 is registered in a parameter (see 3.3). If the waiting time is not configured, zero is set to TIM.
- END.P : If 1 is specified, the end pulse comes out FROM the nDRIVE/END output signal of parallel P I/F after the movement is completed. However, the end pulse pulse must be pre-enabled in mode configuration and the drive end pulse width must be, also, previously configured in parameter configuration.
- Both : When ABS only operates on X-axis, 0 is configured. When the ABS operates on X-axis and Y-axis and waits to be stopped, 1 is configured.
This Both function is only applied to ABS, INC and HOM commands on X-axis.
If Both=1, Y-axis with the same register number must have the same commands (ABS, INC and HOM commands) to move the Y-axis at the same time.

[Caution for the Both function]

Both is a function to move on both of X-axis and Y-axis. Even if one axis stops the movement, two axis simultaneously execute the next register (step) only after the other axis finishes its movement. Note the following cautions to use the Both function.

- When you configure Both as 1 by using ABS, INC or Home command on X-axis, the same register number on Y-axis must be configured as the same command with X-axis.
If another command is configured, an error occurs.
- When you drive Y-axis by means of the Both function in operating the program, the Y-axis program must not be operated.

■ INC relative position movement

CMD	Data	SPD	TIM	END.P	Both
INC	Relative position(-8388608 ~ +8388607)	1~4	0~3	0/1	0/1

Specify the relative position as the distance based on the current position.

●Data : Input the movement distance as the relative value.

This value can be configured in mm or inch if pulse nominator/denominator is configured (refer to 3.3. The default value is the pulse value since the nominator and denominator of pulse scale are equal. The range of data configuration for pulse value is between -8388608 and +8388607.

●SPD : This value selects the drive speed for movement.

Drive speed 1~4 are the speeds registered in Chapter 3.3 configuring parameters.

●TIM : This value specifies the waiting time until the next register is executed after the movement is completed. If 1, 2 and 3 are specified at TIM, the time of the post timer 1~3 is registered in a parameter, refer to 3.3. If the waiting time is not configured, zero is set to TIM.

●END.P : If 1 is specified, the drive end pulse comes out as the nDRIVE/END output signal of parallel P I/F after the movement is completed. However, the drive end pulse must be pre-enabled in mode configuration and the drive end pulse width must be, also, previously configured in parameter configuration.

●Both : When ABS only operates on X-axis, 0 is configured. When the ABS operates on X-axis and Y-axis and both axis wait to be stopped, 1 is configured. This Both function is only applied to ABS, INC and HOM commands on X-axis. If Both=1, Y-axis with the same register number must have the same commands (ABS, INC and HOM commands) to move the Y-axis at the same time.

■ HOM Home search

CMD	Data	SPD	TIM	END.P	Both
HOM	-	-	-	0/1	0/1

Start the home search according to the sequence configured in the home search mode.

●END.P : If 1 is configured, the drive end pulse is sent out as the nDRIVE/END output signal of parallel P I/F after home search is completed. However, the drive end pulse must be pre-enabled in mode configuration and the drive end pulse width must be, also, previously configured in parameter configuration.

●Both : When ABS only operates on X-axis, 0 is configured. When the ABS operates on X-axis and Y-axis and both axis waits to be stopped, 1 is configured. This Both function is only applied to ABS, INC and HOM commands on X-axis. If Both=1, Y-axis with the same register number must have the same commands (ABS, INC and HOM commands) to move the Y-axis at the same time.

■ IJP Jump input condition

CMD	Data1	Data2
IJP	Input port number	Register number to jump

If the input port specified is low level(GEX connection status), jump to the specified register(Data2).

If not, execute the next register.

●Data1 : Specifies input port number. Refer to '4.1.2' for input port number.

●Data2 : Specifies the register number to jump. The range is 0~63.

■ OUT ON/OFF of output port

CMD	Data1	Data2
OUT	Output port number	0(OFF) / 1(ON)

Configure the output port specified as ON or OFF (for Open collector transistor output).

●Data1 : Specifies output port number. Refer to '4.1.2' for output port number.

●Data2 : OFF when zero is configured. If 1, then it is configured as the ON state.

■ OTP ON pulse of output port

CMD	Data1	Data2
OTP	Output port number	ON time(msec)

Configure the output port specified as ON state as much as the time configured(for open collector transistor output)

- Data1 : Specifies output port number. Refer to '4.1.2' for output port number.
- Data2 : Specifies the ON time in msec. the range is 0~65535 msec.

■ JMP Jump

CMD	Data
JMP	Register number to jump

Jump to the register specified.

- Data : Specifies the register number to jump. The range is 0~63.

■ REP Start repetition

CMD	Data
REP	Repetition count

Repeat the execution from the next register of this command to the repetition end command(RPE) as many as the specified count.

- Data : Specifies the repetition count. The range is 1~255. The repetition end command(RPE) must be configured in the lower position(its register number is bigger) than this repetition start command. The repetition loop can be configured up to three times.

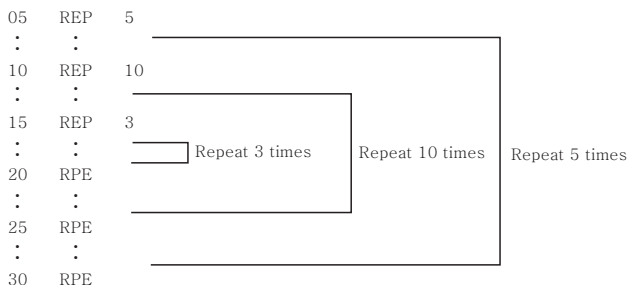

■ RPE End repetition

CMD	Data
RPE	-

Repeat the execution from the repeat start command(REP) to this command.

■ END End program

CMD	Data
END	-

End the program. This command must be written the end of the program.

■ TIM Timer

CMD	Data
TIM	Waiting time(msec)

Execute the current command as much as the specified time.

- Data : Specifies time in msec unit. The range is 0~65535 msec.

■ NOP

CMD	Data
NOP	-

Not operated.

4.1.2 I/O port numbers

■ Input port numbers

Input port No	Connector	Pin No	Signal name	Signal description	Signal type
0	CN4	11	XSTOP0	Near home	X-axis signal
1	CN4	10	XSTOP1	Home	
2	CN4	9	XSTOP2	Encoder Z-phase	
3	CN4	6	XINPOS	Servo inposition	
10	CN5	11	YSTOP0	Near home	X-axis signal
11	CN5	10	YSTOP1	Home	
12	CN5	9	YSTOP2	Encoder Z-phase	
13	CN5	6	YINPOS	Servo inposition	
20	CN3	6	REGSL0	REGSL signal	Parallel P I/F signal
21	CN3	7	REGSL1		
22	CN3	8	REGSL2		
23	CN3	9	REGSL3		
24	CN3	10	REGSL4		

PHC-1HS can not use input port 10-13.

■ Output numbers

Output port No	Connector	Pin No	Signal name	Signal description	Signal type
0	CN4	5	XOUP0	General output X-axis 0	X-axis signal
10	CN5	5	YOUT0	General output Y-axis 0	Y-axis signal

PHC-1HS can not use input port 10.

4.2 Drive by Parallel P I/F(Parallel interface)

The parallel P I/F connector is the P I/F connector (CN3) of the front panel of the main body.

Refer to 7.2 for detailed description of I/O circuit or pin allocation for I/O signal.

This parallel interface is connected to a sequencer or mechanical junction to operate PMC-1HS/PMC-2HS. Each drive other than home search is selected by MODE0 and 1(12-13) signals.

Drive	Operation	MODE1	MODE0
Home Search	Search home according to the home search mode configured.	-	-
Index Drive	Execute the ABS and INC commands registered by specifying register number.	OFF	OFF
Scan Drive	Drive axes while input signal is On.	OFF	ON
Continuous Drive	Drive axes continuously.	ON	OFF
Program Drive	Execute the operation program registered.	ON	ON

This paragraph describes each operation. In this manual, the ON state means the connection of input signal and GEX and the OFF state means the connected signal is open. In addition, the ON/OFF state of output signal means that the transistor output of open collector becomes ON/OFF and the number in parenthesis in the back of signal name means the relevant pin number.

4.2.1 Executing Home Search

After activating the axis specification signal(X:4, Y:5) of the axis to execute, the home search is executed by activating the Home(2) input signal of more than 80 msec. If the Home Search starts, nDRIVE/END(14~15) output signal of the running axis becomes ON. If the Home Search ends, the signal goes to the OFF state. However, if the drive end pulse is enabled in mode configuration, the nDRIVE/END output signal in the OFF state sends out ON pulse as much as the time of the drive end pulse width specified by a parameter at the end of the signal while the axis is searching Home.

Home search for only X-axis is as shown below.

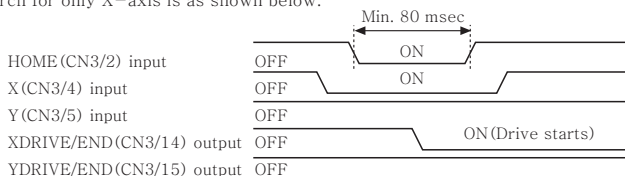

[Caution]

- During Auto Home Search, the soft limit is ignored even if it is enabled.
- For PMC-1HS, the axis specification signal is disabled.
- OFF signals of X and Y DRIVE/END are executed after OFF signal of the Home is confirmed.

4.3 Index Drive

The index drive is the operation to execute ABS and INC commands.

If the following three items are configured as the input signal for the parallel P I/F connector (CN3), the drive start command and STROBE (3) are activated, the drive starts.

Item specified	Input signal configuration of CN3
Operation mode : Index mode	MODE0(12)=OFF, MODE1(13)=OFF
Axis specification	X(4), Y(5)=ON of the axis to execute
Register number specification	Refer to the register number specification table for REGSL0(6)=REGSL5(11)

<Register number specification table>

RGB number	Input signal configuration from REGS0 to REGS5					
	REGSL0(6)	REGSL1(7)	REGSL2(8)	REGSL3(9)	REGSL4(10)	REGSL5(11)
0	OFF	OFF	OFF	OFF	OFF	OFF
1	ON	OFF	OFF	OFF	OFF	OFF
2	OFF	ON	OFF	OFF	OFF	OFF
⋮	⋮	⋮	⋮	⋮	⋮	⋮
16	OFF	OFF	OFF	OFF	ON	OFF
⋮	⋮	⋮	⋮	⋮	⋮	⋮
63	ON	ON	ON	ON	ON	ON

The following figure shows an example to execute X-axis as Index drive.

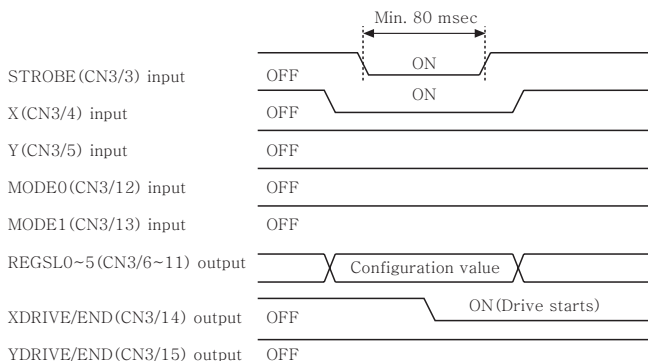

The STROBE signal is activated in ON status and the Index drive operation on the specified axis starts 80 msec later. The STROBE signal must be in on status of more than 80 msec.

In driving, the nDRIVE output signal on the running axis must be in the ON state.

In addition, after the STROBE signal is activated in ON status, the drive speeded up by making the STROBE in the OFF status through the ON status of the nDRIVE signal.

The nDRIVE signal goes to the OFF status if the STROBE signal is checked in OFF status.

For PMC-1HS, X and Y axis signals are disabled.

4.4 Scan Drive

The scan drive outputs drive pulses in + or - direction while its input signal is in ON status.

The drive speed is configured as one of four drive speeds by the input signal SPD0, 1(8, 9).

The scan drive has two operation modes : (1) scan drive1 that two axes can not be operated at the same time and (2) scan drive2 that two axes can be operated at the same time.

■ Scan drive 1

The scan drive1 drives in +/- direction by specifying the axis specification signal(X:4, Y:5) only when the RUN+/- (6, 7) input signal is in ON status. Therefore, X and Y axis cannot be moved simultaneously. The scan drive outputs drive pulses in + direction while RUN+ (6) is in ON status, configuring the following four items as the input signal. It outputs the drive pulses in - direction while RUN- (7) is in ON status.

Items specified	Input signal configuration of CN3
Operation mode specification : Scan mode	MODE0(12) = ON, MODE1(13) = OFF
Scan mode1 specification	SCAN(10) = OFF
Axis specification	X(4), Y(5) = On state of the axis to execute
Drive speed specification	Refer to drive speed configuration for SPD0(8) ~ SPD1(9)

<Drive speed configuration>

Drive speed	SPD1(9)	SPD0(8)
Drive speed1	OFF	OFF
Drive speed2	OFF	OFF
Drive speed3	ON	OFF
Drive speed4	ON	ON

■ Scan drive2

The scan drive2 is the scan operation to move X and Y axis at the same time.

Its input signal is configured as the following three items.

Items specified	Input signal configuration of CN3
Operation mode : Index mode	MODE0(12) = ON, MODE1(13) = OFF
Scan mode1 specification	SCAN(10) = OFF
Drive speed specification	Refer to drive speed configuration for SPD0(8) ~ SPD1(9)

While the input signals in the table below is in the ON state, drive pulse is outputted to each axis direction.

Axis direction for scan drive	Input signal in ON status
+ direction of X- axis	SCANX+ (6)
- direction of X- axis	SCANX- (7)
+ direction of Y- axis	SCANY+ (4)
- direction of Y- axis	SCANY- (5)

[Caution] When the scan drive2 is running, do not execute the Home Search by the Home(2) signal.

4.5 Continuous Drive

The continuous drive outputs drive pulses in + direction when the input signal RUN+ (6) is in ON state or in - direction when the input signal RUN- (7) is in ON state. It outputs the drive pulse until the stop signal STOP(11) goes to the ON state, in other words, the RUN signal of the drive is changed into the Stop signal (If the Limit input in the proceeding direction is activated, the output stops).

The drive speed is configured as one of four drive speeds (from drive speed1~4) by the input signal SPD0 and 1(8, 9). If the configuration of the drive speed is changed in driving, the speed is changed into the changed speed at once.

Item specified	Input signal of CN3
Operation mode specification : Continuous mode	MODE0(12) = ON, MODE1(13) = OFF
Axis specification	X(4), Y(5) = On state of the axis to execute
Drive speed specification	Refer to drive speed configuration for SPD0(8) ~ SPD1(9)

4.6 Program Drive

The program drive executes the operation program registered. The program drive is started by configuring the following items as the input signal of parallel P I/F connector(CN3) when the drive start command, STOBE(3) is in ON state.

Item specified	Input signal configuration to CN3
Operation mode : Index mode	MODE0(12) = ON, MODE1(13) = ON
Axis specification	X(4), Y(5) = ON state of the axis to execute
Register number specification	Refer to "Register number specification table in chapter 4.3" for REGSL(6) ~ REGSL5(11).

5. Drive by PC

Connect PMC-1HS/PMC-2HS to PC using a communication cable. Start the operation program to configure as shown below.

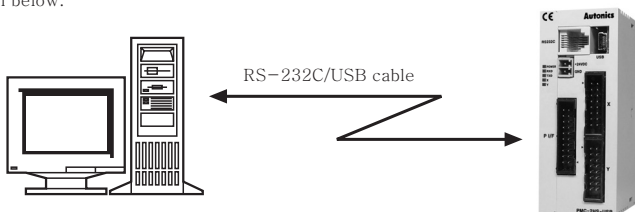

Screen to handle	Handling item
Main screen	JOG operation on each axis(scan, continuous, pre-set) Execution of Home Search, Index drive and program SAVE and OPEN of operation mode, parameters and program files
Parameter mode screen	Mode configuration Parameter configuration Home Search mode configuration
Program edit screen	Edit of operation program
I/O signal screen	Display of input signal status, output signal configuration

Hereinafter, this chapter describes each configuration according to the sequence of Windows screen.

5.1 Start of operation program

Start the operation program on PC as the following procedure.

- Connect PMC-1HS/PMC-2HS to a PC using a RS232C communication cable or an USB communication cable.
- Turn on the main body and the PC. If the USB cable is connected initially, new hardware is detected. Install the driver using the provided CD.
- Start the operation program by clicking the Start button.
Click Start → Program → Autonics Motion Controller → PMC → PMC-HS.
If the communication with the main body is normal, all data configured to the main body(Operation mode, parameters and operation program) is uploaded on the PC and the main screen is displayed.
If the communication with the main body is abnormal, the following message is popped up.



Click the screen to execute the program on off-line. Select PMC-1HS or PMC-2HS to display the main screen.

[Caution] When you start the operation program after installing, the program may be displayed in off-line even though a communication cable is connected. To solve this program, click the option menu on the main screen, mark the COM port connected to the main body and restart the operation program.

In case of the USB communication, In USB communication, if you select My computer → Properties (Click your right mouse button) → Hardware → Device Manager, you can check the COM port to be allocated next to "Prolific USB-to-Serial Comm Port" in Port (COM and LPT).

5.2 Main Screen

Run the operation program to display the main screen. On this screen, you can execute:

- JOG operation on each axis (scan, continuous and pre-set)
- Execution of Home Search, Index drive and program
- SAVE and OPEN of operation mode, parameters and program files

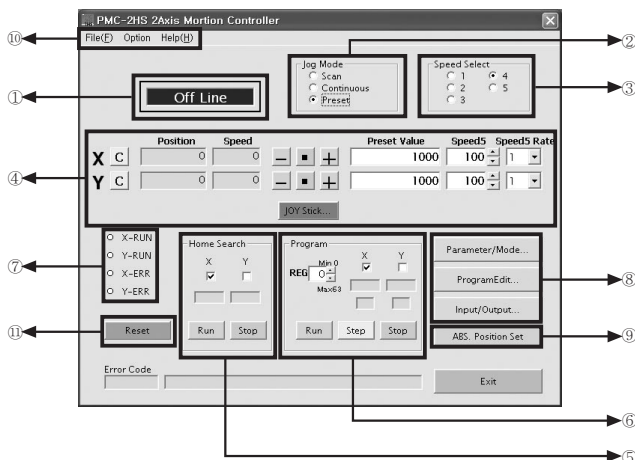

① Main body connection status

If the screen displays on-line, the program is being connected to the main body and serial communication. If off-line, it is not connected to the main body but you can write the operation program. In off-line, you can read files from the hard disk by means of Open or Save from the File menu and save the written program.

② Selecting JOG mode

You can operate JOG in three ways on the main screen.

Display	Operation	Handling item
Scan	Scan	Only drives while you press the direction button.
Continuous	Continuous	Start to drive if you press the direction button and continue to drive until you press the stop button.
Preset	pre-set	Drives as many as the Preset Value movement if you press the direction button.

③ Selecting drive speed

This function selects the drive speed of JOG operation. Speed 1~4 means the drive 1~4 configured on the parameter screen. Speed 5 means the speed configured as speed5 on the screen. The speed can be changed in driving.

④JOG operation

Display	Operation
<input type="button" value="+"/>	Outputs drive pulses in + direction.
<input type="button" value="-"/>	Outputs drive pulses in - direction
<input type="button" value="■"/>	Stops the drive.
Preset value	Configures the movement amount in pre-set operation. This value applies the scale function. Refer to the item of pulse scale numerator in parameter configuration.
Speed 5	Configures the value of speed 5. The range is 1~8000. If you click the increment/decrement button(▼▲), the configuration value is increase/decrease depending on the selection of the increment. The actual drive pulse speed is the configuration value multiplied by the speed multiplied (see parameter configuration). If the speed 5 is selected, the speed can be changed in driving according to the change of the configured value.
Speed 5 Rate	Determines the speed increment of Speed 5. If 10 is selected, the value of the Speed 5 is increased/decreased as many as 10 once you click the increment/decrement button(▼▲).
Position	Displays the current position. It ignores the power ON mark. If the Home Search is executed, zero is displayed. If you click the position clear button (C button), you can clear the current position at any position. This value applies the scale function. Refer to the item of pulse scale numerator in parameter configuration.
Speed	Displays the current speed in driving.
<input type="button" value="C"/>	Makes the Position value(current position) as zero.

■ JOY Stick

If you click the joy stick button on the main screen, the following screen pops up.

The joy stick can freely configure the position of X+, X-, Y+ and Y- keys and can drive X and Y axes at the same time.

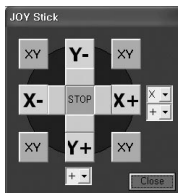

⑤Home Search execution

This function executes the Home Search of each axis.

The selection of Home Search mode or Home Search speed is configured on the parameter/mode screen.

Display	Operation
X, Y	Selects the axis to carry out the Home Search.
Run	Starts the Home Search.
Stop	Stops the Home Search.

⑥Program execution

This function executes a program. To run a program, the program must be written on the program edit screen and the required items must be configured on the parameter/mode screen.

Display	Operation
REG	Configures the starting register number.
X, Y	Selects the axis to execute.
<input type="button" value="Run"/>	Starts the program from the register number configured.
<input type="button" value="Step"/>	Executes only the register numbers configured. However, only ABC, INC, HOM, OUT and OTP commands are available.
<input type="button" value="Stop"/>	If you click this Stop button after pressing the Run button, the current command in use pauses. After then, click the Stop button again to close your program. However, if you click the Run button, the current REG program is operated.

[Caution] Do not change program, parameter or mode when the program is running.

⑦ Display drive status

Display	Operation
n-RUN	Lights LED when the relevant axis is driving or running a program.
n-ERR	Lights when limit over or servo alarm occurs and displays an error message at the bottom of the screen when an error occurs.

⑧ Start of the Sub screen

Display	Operation
Parameter/Mode	Starts the parameter/mode screen.
Program Edit	Starts the program edit screen.
Input/ Output	Starts the I/O signal screen.

⑨ Register of the current position

The current position indicated in position is configured to the REG of 'Running program (⑥)' as the format of the ABS command. The configuration only corresponds to the axis selected in 'Running program (⑥)'.

- The drive speed is configured as the value selected in 'Selecting drive speed (③)'.

However, if Speed 5 was selected, Speed 4 is configured.

- TIM and END.P are configured as zero.
- Both is configured as 1 if both of X and Y are selected or zero for others.

If the current position is configured, the REG number in 'Running program (⑥)' is increased by one.

⑩ Configuration of file management and communication

The file menu has the functions as listed in the table below. The data to be transmitted are the configuration value of the parameter/mode screen and the program of the program edit screen. The data transmission from the main body can be sent all data together or some data.

File menu	Function	Description
Open	Read a file	Data is read from a file on a disk. The data opened is, also, written to the main body in On-line. The extension name of the data file is *.nvd.
Save	Save a file	Data is stored in a disk along with its file name. The extension name of the data file is *.nvd.
Upload	Read from PMC-1HS/PMC-2HS	Data is read from the main body. All All data Program-All All program Program-X axis Program data on X axis Program-Y axis Program data on Y axis Parameter-All All parameter/mode Parameter-X axis Parameter/mode on X axis Parameter-Y axis Parameter/mode on Y axis 【Caution】 If the operation program is started in on-line, upload is automatically configured.
Download	Add to PMC-1HS/PMC-2HS	Data is added to the main body. All All data Program-All All program Program-X axis Program data on X axis Program-Y axis Program data on Y axis Parameter-All All parameter/mode Parameter-X axis Parameter/mode on X axis Parameter-Y axis Parameter/mode on Y axis 【Caution】 If data is added or changed on the parameter/ mode screen or the program edit screen in on-line, the data is automatically added to the main body. Therefore, additional download is not required.

In the Option menu, you can mark serial communication port and select communication speed. The serial communication port that your PC can use is displayed in COM port numbers.

For communication, the COM port must be marked.

In USB communication, if you select My Computer → Properties (click your right mouse button) → Hardware → Device Manager, you can check the COM port to be allocated next to "Prolific USB-to-Serial Comm Port" in Port (COM and LPT). The communication speed has the range from 9600bps to 115200 bps. The default value is 9600bps. Faster communication speed makes faster response of the main body but is subject to receive the influence of noise. The Help menu indicates the version of the main body or the operation program. The top end and the bottom end indicate the versions of the main body and the operation program respectively (Version : ***** and Version of app : *****).

① Main body reset

This function is used to reset PMC-1HS/PMC-2HS main body.

5.3 Parameter/Mode Screen

The parameter/mode screen of the Sub screen is used to configure modes, parameters and home search mode. This screen has Mode, Parameter and Home Search Mode tab.

5.3.1 Mode Tabs

The mode tabs are used to configure operation modes. Each mode is selected in the list by clicking (▼). In online status, if each value is added or changed, the value is automatically added to the main body.

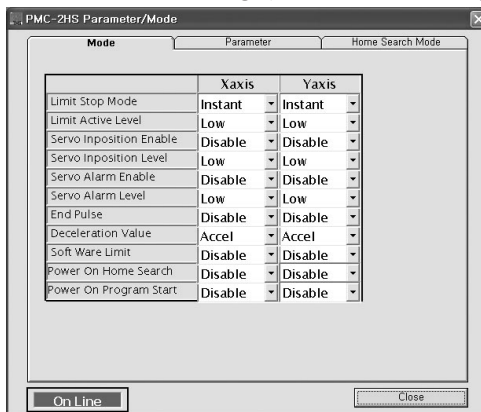

The mode tabs are as listed in the table below. For more description of each, refer to 3.2.

Display	Selection	Default value
Limit Stop Mode	Instant/Slow	Instant
Limit Active Level	Low/High	Low
Servo Inposition Enable	Disable/Enable	Disable
Servo Inposition Level	Low/High	Low
Servo Alarm Enable	Disable/Enable	Disable
Servo Alarm Level	Low/High	Low
End Pulse	Disable/Enable	Disable
Deceleration Value	Accel/Decel	Accel
Soft Ware Limit	Enable/Disable	Disable
Power On Home Search Start	Enable/Disable	Disable
Power On Program Start	Enable/Disable	Disable

5.3.2 Parameter Tabs

Configure operation parameter and required parameter for X or Y axis.

The configurable range of each item is displayed in Range of Value. In online status, if each value is changed, the value is automatically added to the main body.

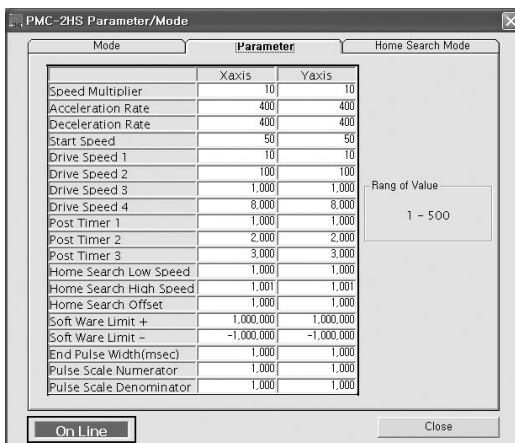

The parameter tabs are listed in the following table. For detailed description of each parameter, refer to 3.3.

Display	Input range	Default value
Speed Multiplier	1 ~ 500	10
Acceleration Rate	1 ~ 8000	400
Deceleration Rate	1 ~ 8000	400
Start Speed	1 ~ 8000	50
Drive Speed 1	1 ~ 8000	10
Drive Speed 2	1 ~ 8000	100
Drive Speed 3	1 ~ 8000	1000
Drive Speed 4	1 ~ 8000	8000
Post Timer 1	1 ~ 65535(msec)	10
Post Timer 2	1 ~ 65535(msec)	100
Post Timer 3	1 ~ 65535(msec)	1000
Home Search Low Speed	1 ~ 8000	20
Home Search High Speed	1 ~ 8000	1000
Home Search Offset	-8388608~+8388607 (Note1)	+100
Soft Ware Limit +	-8388608~+8388607 (Note1)	+8388607
Soft Ware Limit -	-8388608~+8388607 (Note1)	-8388608
End Pulse Width(msec)	1 ~ 65535(msec)	100
Pulse Scale Numerator	1 ~ 65535	1000
Pulse Scale Denominator	1 ~ 65535	1000

※ (Note 1) : When the numerator and the denominator of pulse scale are equal.

5.3.3 Home Search Mode Tabs

Configure home search mode. Each mode is selected in the list by clicking (▼).

In online status, if each value is changed, the value is automatically added to the main body.

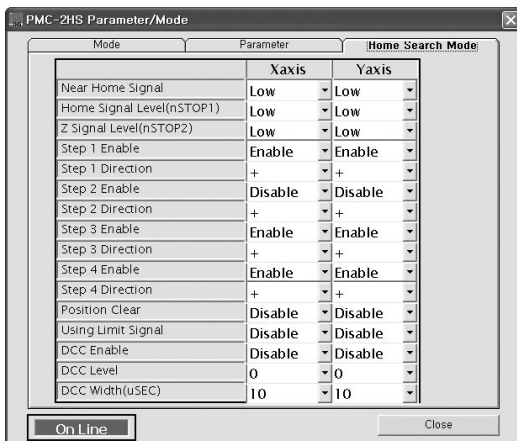

Home search mode tabs are listed in the following table. For detailed description of each parameter, refer to 3.4.

Display	Selection	Default value
Near Home Signal Level(nSTOP0)	Low/High	Low
Home Signal Level(nSTOP1)	Low/High	Low
Z Signal Level(nSTOP2)	Low/High	Low
Step 1 Enable	Disable/Enable	Disable
Step 1 Direction	+ / -	-
Step 2 Enable	Disable/Enable	Disable
Step 2 Direction	+ / -	-
Step 3 Enable	Disable/Enable	Disable
Step 3 Direction	+ / -	+
Step 4 Enable	Disable/Enable	Disable
Step 4 Direction	+ / -	+
Position Clear	Disable/Enable	Enable
Using Limit Signal	Disable/Enable	Disable
DCC Enable	Disable/Enable	Disable
DCC Level	0 / 1	0
DCC Width (μ sec)	10, 20, 100, 200, 1000, 2000, 10000, 20000	10

5.4 Program Edit Screen

The program edit screen is used to display/edit the operation program of X or Y axis.
The program is registered to registers from 0~63.

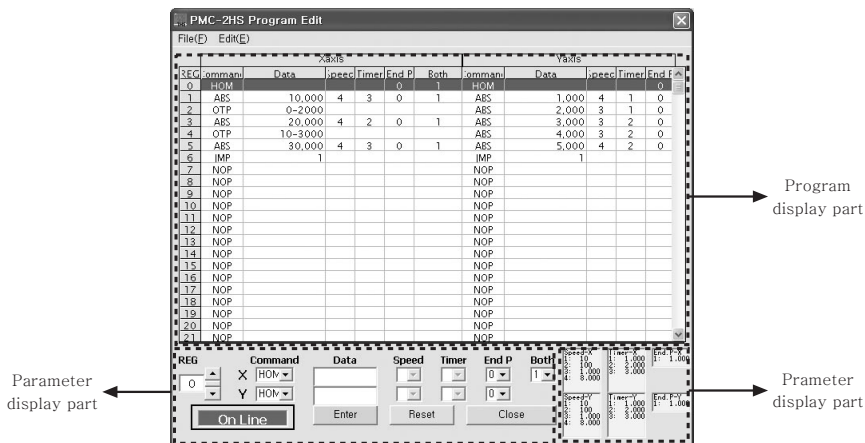

The program edit screen consists of the program display part, the program input part and the parameter display part. The input or edit of the program is carried out in the program input part. If you click a certain register in the program display part, the selected register number is displayed in the REG field of the program input part.

■ Input and edit a program

For the displayed register, input each item as shown below. Whenever you click the Enter button, data is displayed at the corresponding REG of the program display part and the register number is increased by one. In online state, the data is automatically added in the main body.

Input item	Command	Description
Command	Click (▼) to select the following commands. ABS(Move absolute position), OUT(ON/OFF of output port), IJP(Jump of input condition), INC(Move relative position), NOP(No-operation), OTP(ON pulse from output port), JMP(Jump), HOM(Home Search), REP(Start repetition), TIM(Timer), RPE(End repetition), END(Close the program)	
Data	ABS	Absolute position
	INC	Relative position
	OUT	Output post number – 0(Off)/1(On)
	OTP	Output post number – ON time(0~65,5350 msec)
	IJP	Input port number – register number to jump
	JMP	Register number to jump
	REP	Repetition count (1 – 255)
Speed	ABS, INC	Selection of drive speed 1 ~4
	Other commands	Not required to configure
Timer	ABS, INC	Selection of post timer 1~3 If it is unnecessary, select zero.
	Other commands	Not required to configure

End P	ABS, INC, HOM	1 : Output the end pulse after running the command 0 : No-output after running the command [Caution] For 1, the drive end pulse must be enabled in mode configuration.
	Other command	Not required to configure
Both	ABS, INC and HOM on X axis	1 is configured when the same commands executes the drive on Y axis.
	Other command	Not required to configure

●Reset : If the Reset button is pressed before the Enter button is pressed, the input data is reset and the previous data is displayed.

[Caution] After entering data, press the Enter button to update the program.

■File menu

The File(F) menu on the Program Edit screen has Save, Open commands for the operation program.

This menu has the same function with the File menu of the main screen.

■Edit menu

The Edit (E) menu of the Program Edit screen is listed as shown the table below.

Item	Function	Description
Cut	Clear of the selected area	Move the selected area to the clipboard. In online state, the program data of the changed register is added to the main body.
Copy	Copy of the selected area	Copy the selected area to the clipboard.
Paste	Paste	Paste the selected area to the current register. In online state, the program data of the changed register is added to the main body.
Delete	Deletion of lines	Delete the selected register in line unit. The register number after the deletion can be advanced. In online state, the program data after the deleted line is added to the main body.
Insert	Insertion of lines	Insert blanks to the selected line. If the last line number of the program after inserting blanks is over 63 with the numbers or more than 63 are deleted. In online state, the inserted program data is added to the main body.

5.5 I/O Signal Screen

I/O Signal screen displays the current status of the input signal in driving and used to configure the manual of the output signal. The I/O Signal screen is only operated in online state.

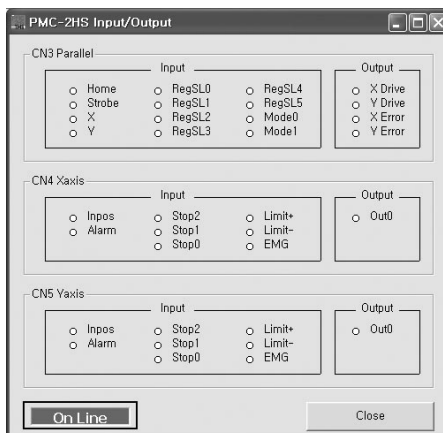

Input signal status of CN4 and 5 lights when the signal is active. For example, the limit signal(nLMT+/-) lights when the limit active level is low, which is the signal is connected to GND, by the mode configuration. The input signal of parallel P I/F (CN3) lights when the input signal is connected to GEX and its output signal lights when the signal is ON, which is the output transistor is ON. If you double-click the signal name, the ON/OFF output is reversed.

5.6 Errors

Errors listed in the table below are displayed at the bottom of the main screen.

Code	Error message	Description
208	SOFTWARE LIMIT + ERROR	Software LMT+ occurred
209	SOFTWARE LIMIT - ERROR	Software LMT- occurred
210	HARDWARE LIMIT + ERROR	nLMT+ signal is active level
211	HARDWARE LIMIT - ERROR	nLMT- signal is active level
212	ALARM ERROR	nALARM signal is activated by the Enable configuration
213	EMG ERROR	EMG is low level (GEX connection)
214	PROGRAM ERROR	Program error
215	HOME ERROR	Home Search error of the main body
401	Break signal was received	The stop signal is received.
402	Frame error	Frame error
403	Port Overrun error	Port overrun
404	Recive buffer Overflow	Receive buffer overflow
405	Parity error	Parity error
406	Send buffer Full	Send buffer is full
407	Device control block of Port was received	Unexpected error acquiring the device control block (DCB) of a port
408	There is no response	No response for the command
501	X Axis is already driving now	X axis was driven during the operation of X axis
502	Y Axis is already driving now	Y axis was driven during the operation of Y axis
503	Please select Axis	Home Search and Index/Program was selected without selecting any axis on the main screen.
504	Please input number from 0~63 for REG	A number other than 0~63 was inputted in REG
505	Please input number	Not specified value was input.
506	Please input number within the limits	A value other than input range was input.

The online state can be changed into the offline state when a communication error is occurred.

To recover the online state, select the File (F) and retry the communication such as Upload → Parameter → X axis.

6. Drive by Teaching Unit

The teaching unit (PMC-2TU-232) is a device that builds the operation mode parameter and operation program for the main body without a PC. In addition, it can carry out the start of the operation program, the home search and JOG operation. The teaching unit is used by connection the private cable (1.5m) in a packing box to the RS-232C connector (CN2) of the main body.

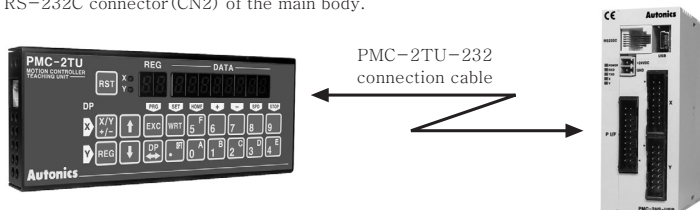

The teaching unit consists of data edit mode and drive handling mode. The data edit mode displays a register number to the REG of the display part, and the drive handling mode displays dp (drive operation). When turned on, it starts as the drive handling mode (dp display).

DP key is used to convert the status of the data edit mode and the drive handling mode.

Mode	Operation	REG display
Data edit	<ul style="list-style-type: none"> • Adding operation mode parameter and operation program • Index drive operation 	Register number
Drive handling	<ul style="list-style-type: none"> • Displaying the current position • JOG operation • Home search • Program execution 	<p>dp</p> <p>(drive operation)</p>

The front of the teaching unit is as shown below:

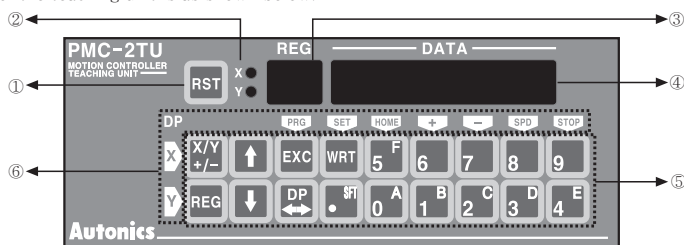

- ①Reset : Resets the main body and the teaching unit.
- ②X/Y display : Displays the currently selected axis.
- ③Register number display/dp : Displays the currently selected register number when data is editing and dp when drive handling.
- ④Data display : Displays the data of each register when data is editing and the current position of the selected axis when drive is handling.
- ⑤Input key
 - X/Y : Converts the selecting axis. It is used to convert the sign of an input value when the value is entered and a mode data that the mode data is entered.
 - REG : It is used to input the register number to display. If the key is pressed on the data input, the data input is cancelled and returns to the state before the data input.
 - ↑ ↓ : Increases/decreases the displayed register number.
 - EXC : Runs the displayed command. However, this command is only valid for ABS, INC, OUT, OTP and HOM 1~4 commands.
 - DP : Converts the drive handling status and the data edit status.
 - WRT : Adds a value when data is editing.
- ⑥Key display for drive operation : Displays key function as yellow letters to the left or the top of the input key in drive handling status. The top end and the bottom end of the key handle X-axis and Y-axis respectively.

6.1 Operation of the data edit

The data edit includes input, display and change the operation mode • parameter or the operation program. In data edit mode, a register number between 00 and 95 is displayed. In the drive handling mode, the REG key displays dp. Therefore, change into the drive edit mode by pressing the dp key.

6.1.1 Register Selection

There are 89 registers from REG00 to REG95 with the exception of REG64 to REG70 on each axis. There are two ways to display registers.

①Press REG key to input a register number as two digits.

Example : REG 04 ---- REG → 0 → 4

②Press ↑ or ↓ key to change a register number.

If you give the key a short press, the number increases by one. Otherwise, the number increases continuously. However, if ABS and INC commands were configured in the register, the short press displays a position data and the operation mode. If you press the key again, the next register is displayed.

6.1.2 Register Composition

The register configuration is displayed by a teaching unit as listed in the table below.

REG No.	Description	Data type		Note
00~63	Operation program	Value data	Mode data	
64~70	Empty	●	●	
71	Operation mode 1			
72	Operation mode 2		●	
73	Axis input signal filter is not changeable		●	Not changeable
74	Speed multiplier(1 - 500)	●		
75	-			
76	Acceleration rate(1 - 8000)	●		
77	Deceleration rate(1 - 8000)	●		
78	Start speed (1 - 8000)	●		
79	Drive speed 1(1 - 8000)	●		
80	Drive speed 2(1 - 8000)	●		
81	Drive speed 3(1 - 8000)	●		
82	Drive speed 4(1 - 8000)	●		
83	Home search high speed(1 - 8000)	●		
84	Home search low speed(1 - 8000)	●		
85	Home search mode 1		●	
86	Home search mode 2		●	
87	Home search offset(-8388608 ~ + 8388607)	●		
88	Software limit +(-8388608 ~ + 8388607)	●		
89	Software limit -(-8388608 ~ + 8388607)	●		
90	Post timer 1(1 ~ 65535)	●		
91	Post timer 2(1 ~ 65535)	●		
92	Post timer 3(1 ~ 65535)	●		
93	Drive and Pulse width(1 ~ 65535)	●		
94	Pulse scale numerator	●		Not changeable
95	Pulse scale denominator	●		Not changeable

[Caution] The teaching unit (PMC-2TU-232, it is optional.) does not have the pulse scale function. All of the position data of REF00~63 and the parameters of REG 87, 88 and 89 become pulse values. Parameters of REG 94 and 95 cannot be changed.

6.1.3 Input of the Operation Program

The operation program is registered at registers number 00~63.

Each command and input method in the teaching unit are listed in the table below.

Comm -and	Display	Input method																						
		Input operation	Description																					
ABS INC	<p>ABS display Absolute position</p> <p>INC display Relative position</p> <p>Mode</p> <p>ABS/INC configuration 0:INC, 1:ABS</p> <p>Drive speed 1, 2, 3, 4</p> <p>Post timer 0, 1, 2, 3</p> <p>End P 0:OFF, 1:ON</p> <p>Both 0:OFF, 1:ON</p> <p>The selected mode is lighted in mode display</p>	1	Press the WRT key.	The ABS display is flickered in the command input state.																				
		2	Select a command using the ↑ or ↓ key.	ABS display : ABS INC display : INC																				
		3	Press the WRT key.	The command is confirmed.																				
		4	Input position data (Input in pulse unit)	A sign is entered by pressing the +/- key.																				
		5	Press the WRT key.	Its position data is confirmed and its mode is displayed.																				
		6	Configure each mode by means of the +/- key and the ● key	The flickering value is changed by means of the +/- key, the selected item is moved by means of the ● key.																				
		7	Press the WRT key.	The position data flickers twice to inform the completion of the registration.																				
HOM	The HOM command selects HOM1 ~ HOM4 depending on Enable/Disable configuration of End P and Both.			1	Press the WRT key.																			
	<table border="1"> <thead> <tr> <th></th> <th>Display</th> <th>End P</th> <th>Both</th> </tr> </thead> <tbody> <tr> <td>HOM1</td> <td>Hon1</td> <td>Disable</td> <td>Enable</td> </tr> <tr> <td>HOM2</td> <td>Hon2</td> <td>Disable</td> <td>Enable</td> </tr> <tr> <td>HOM3</td> <td>Hon3</td> <td>Disable</td> <td>Enable</td> </tr> <tr> <td>HOM4</td> <td>Hon4</td> <td>Disable</td> <td>Enable</td> </tr> </tbody> </table>		Display	End P	Both	HOM1	Hon1	Disable	Enable	HOM2	Hon2	Disable	Enable	HOM3	Hon3	Disable	Enable	HOM4	Hon4	Disable	Enable	2	Select a command using the ↑ or ↓ key.	Select HOM1 ~ HOM4
		Display	End P	Both																				
	HOM1	Hon1	Disable	Enable																				
HOM2	Hon2	Disable	Enable																					
HOM3	Hon3	Disable	Enable																					
HOM4	Hon4	Disable	Enable																					
		3	Press the WRT key.	The display flickers twice to inform the completion of the registration.																				
		【Caution】 HOM 3 and 4 cannot be selected for Y axis.																						
JMP REP TIM	<p>REG to jump</p> <p>Repetition count</p> <p>Time configuration</p>	1	Press the WRT key.	The ABS display is flickered in the command input state.																				
		2	Select a command using the ↑ or ↓ key.																					
		3	Press the WRT key.	The command is confirmed.																				
		4	Input a value.	Input numbers are displayed from the right of the DATA																				
		5	Press the WRT key.	The position data flickeres twice to inform the completion of the registration.																				

OUT IJP OTP		1	Press the WRT key.	The ABS display is flickered in the command input state.
		2	Select a command using the ↑ or ↓ key.	
		3	Press the WRT key.	The command is confirmed.
		4	Input the first value (Left side)	
		5	Press the ● key.	Wait for the input of the second(right) value.
		6	Input the second value(right side).	
		7	Press the WRT key.	The display flickeres twice to inform the completion of the registration.
<p>【Caution】 In the teaching unit, the pulse width of the OPT command is configured within the range of 0-99(msec). If the value registered by a PC exceeds the range, the pulse width is not displayed. (The width is displayed as --.)</p>				
RPE NOP END		1	Press the WRT key.	The ABS display is flickered in the command input state.
		2	Select a command using the ↑ or ↓ key.	
		3	Press the WRT key.	The display flickers twice to inform the completion of the registration.

Press the REG key to cancel the input and return to the previous data.

【Caution】 Input position data in pulse unit.

The teaching unit (PMC-2TU-232) does not have the pulse scaling function.

6.1.4 Input of Operation Mode and Parameters

The operation mode and the parameters are registered in REG71 to REG95.

The display and input methods in the teaching units are as follows:

Parameter /Mode	REG	Display	Input method		
			Input	Description	
Parameter	74 : 84 87 : 95	The value of each parameter is displayed in Data.	1	Press the WRT key	Input mode
	2		Input a value	Use of the number key	
	3		Press the WRT key	The display flickers twice to inform the completion of the registration.	
Mode	71 72 85 86	<p>Data display part</p> <p>8 7 6 5 4 3 2 1</p> <p>For the items displayed as 8-digit at the data display part for each register, refer to "■Mode display (page 42)".</p>	1	Press the WRT key	In input mode, the mode of 1 in the Data display part is selected.
	2		Configure each mode by means of the +/- key and the ● key.	The flickering value is changed by means of the +/- key, the selected item is moved by means of the ● key.	
	3		Press the WRT key	The display flickers twice to inform the completion of the registration.	

6.1.5 Index Drive

Execute the command of the register displayed in the data mode is executed once.

If you press the EXC key after selecting an axis via the X/Y key, the command of the register currently displayed is executed. However, the executable commands are limited as ABS, INC, OUT, OTP and HOM1~4. Other commands are not executed by pressing the EXC key. This function is normally executed for only one axis. However, if ABS, INC and HOM1~4 commands are configured as Both for X axis, the commands are simultaneously executed for X/Y axis by the input of the EXE key on X axis.

6.2 Drive operation

In drive handling mode, you can carry out JOG movement, Home Search and program execution. REG displays dp in the drive handling mode. When a register number is displayed, press the DP key to convert into the mode. In the mode, Data displays the current position of the selected axis.

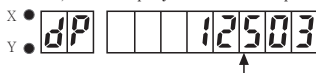

Position data of the selected axis

The key to handle is displayed in yellow letters on the left or the top of the input keys and the higher end and the lower end of the key are used to handle X-axis and Y-axis respectively. The yellow letters above the input key describes each function. However, the DP key only has the data edit/drive handling change function.

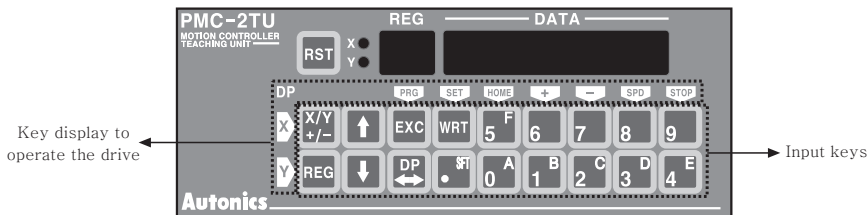

6.2.1 Home Search

The keys to carry out the home search are listed in the table below.

Yellow Letter Displayed	Input key	Operation
X HOME	5	Home search on the X-axis
Y HOME	0	Home search on the Y-axis

Both of X and Y axes can be simultaneously handled.

If you stop the operation, press the STOP key of each axis.

[Caution] If the operation mode, parameter and home search mode are not configured before executing the home search, the home search is not performed correctly.

6.2.2 JOG operation

The JOG operation in the teaching unit is the operation to drive in the specified direction only when a key is pressed. In addition, the drive speed can be changed.

Yellow letter mark	Input key	Operation
X +	6	JOG shift in the + direction on X axis
X -	7	JOG shift in the - direction on X axis
Y +	1	JOG shift in the + direction on Y axis
Y -	2	JOG shift in the - direction on Y axis
X SPD	8	Whenever these keys are pressed, the drive speed is changed between zero and four. The drive speed 1~4 output the values configured by REG 79~82 and the drive speed 0 outputs the single pulse. If you press first, the currently registered speed is displayed. If you press continuously, the speed is changed.
Y SPD	3	

6.2.3 Execution of Operation Program

The registered operation program is carried out from the specified register number. The program can operate only X-axis, Y-axis or both of X and Y simultaneously. It is not allowed to execute Y-axis on operating X-axis, or vice versa. The procedure to execute the program is listed in the table below.

Order	Input Procedure	Operation
1	Press the EXC key.	Executing a program
2	Select an axis by pressing the X/Y key	If the X/Y key is pressed, X-axis, Y-axis and X/Y axis is selected in turn and the lamp is also changed.
3	Input register numbers	Input the number of the start register between 0~63.
4	Press the EXC key	The program is executed from the inputted start register.

(Example) To execute X-axis from REG10.

EXC → [X/Y] → 1 → 0 → EXC

To stop the program execution in operating, press the STOP key (9 for X-axis, 4 for Y-axis) on each axis. In running, the current position on the selected axis is displayed. In other words, if X-axis or Y-axis is operating, the current position on X-axis or Y-axis is displayed respectively.

However, if X/Y axis is operating, the current on X-axis is displayed. Once the program is running, you can monitor the current position by selecting an axis by means of the X/Y key.

6.2.4 Record of the Current Position

Record(teaching) of the current position is the function to register the current position as the absolute position(ABS) to registers. Before entering to the drive operation(dp mark) mode, the current position as the absolute position is recorded to the register with the number displayed by the data edit mode.

Therefore, the record of the current position is required to selectively display the register to register in the Data edit mode in advance. The procedure to record the current position is listed in the table below.

Order	Procedure	Description
1	Selectively display the register to add the current position in the data edit mode.	The current position is recorded to the displayed register.
2	Press the DP key to change into the drive operation mode.	
3	Move an axis to the position to record by means of the + or - key for each axis.	The drive speed can be changed.
4	Press the X/Y key to select an axis to record.	The lamp for the selected axis is turned on. The current position is recorded one axis by one axis. X/Y axis can not be recorded at the same time.
5	Write the WRT key.	The current position data flickers requiring the confirmation of the recorded data. You can cancel the recorded data by pressing the DP key.
6	Press the WRT key again.	The mode returns to the data edit mode(register display). The data lights twice to inform that the current position is recorded as the absolute position (ABS). To add again, repeat from #2~#6.

【Change the mode】

In the current position addition mode, ABS and drive speed are auto-configured as 1, and post timer, End P and Both are auto-configured as 0. If necessary, the mode configuration can be reset.

If you press the ↑ key, when the mode is displayed, you may change each mode of the configured mode by pressing the WRT key.

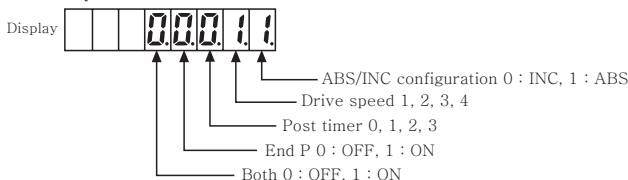

7. Product Specifications and I/O Signal Connection

7.1 Product Specifications

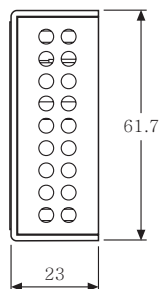
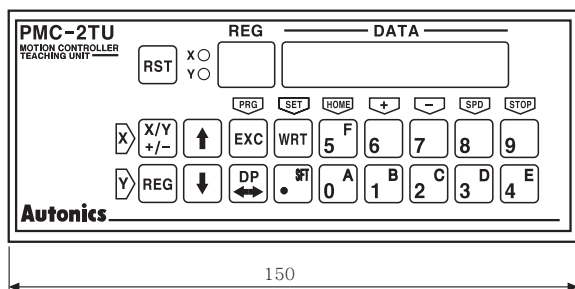
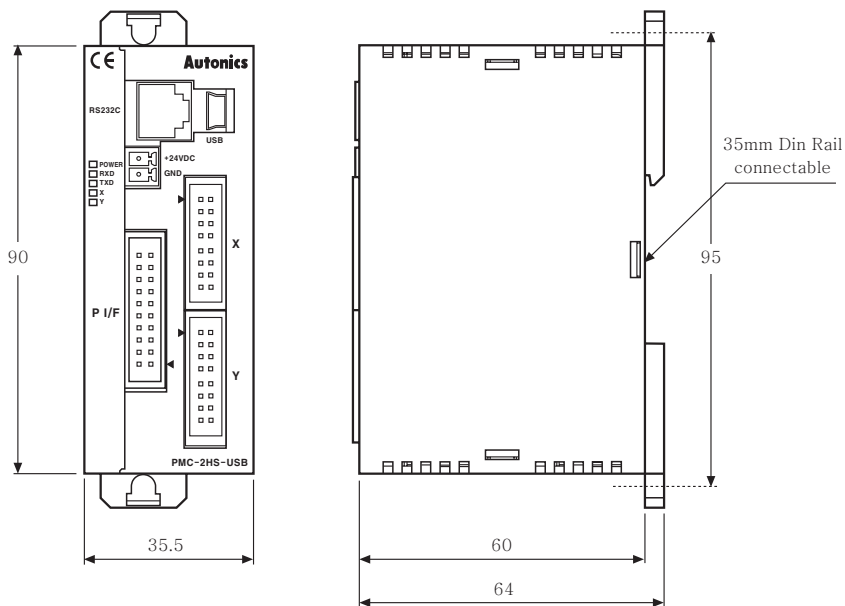

(Unit:mm)

Specifications	PMC-1HS(232/USB)	PMC-2HS-USB									
Control axis numbers	1 axis	2 axis(Each axis can be independently programmed)									
Motor for control	Pulse train input stepping motor or servo motor										
Index numbers	64 indexes per axis										
Range for the index pulse configuration	-838608 ~ +838607(Configurable absolute value/relative value) Pulse scaling function										
Drive speed numbers	4										
Range for the drive speed configuration	1 pps~4 Mpps(1~8000×Magnification 1~500)										
Operation mode	<ul style="list-style-type: none"> • Home Search • Scan Drive • Continuous Drive • Index Drive • Program Drive 										
Home Search operation mode	High speed near home search(Step1) → Low speed near home search(Step2) → Low speed Z-phase search(Step3) → High offset movement(Step4). Configuring the detection direction and Enable/Disable in each step.										
Program function	<ul style="list-style-type: none"> • Memory : EEPROM • 64-step • 12-command • Auto-start function of power on program 	<table border="1"> <thead> <tr> <th>Drive</th> <th>ABS INC HOM</th> <th>Absolute position movement Relative position movement Home search</th> </tr> </thead> <tbody> <tr> <th>Input/Output</th> <th>IJP OUT OTP</th> <th>Jump input condition ON/OFF of output port ON pulse of output port</th> </tr> <tr> <th>Program control</th> <th>JMP REP RPE END TIM NOP</th> <th>Jump Start repetition End repetition End program Timer</th> </tr> </tbody> </table>	Drive	ABS INC HOM	Absolute position movement Relative position movement Home search	Input/Output	IJP OUT OTP	Jump input condition ON/OFF of output port ON pulse of output port	Program control	JMP REP RPE END TIM NOP	Jump Start repetition End repetition End program Timer
Drive	ABS INC HOM	Absolute position movement Relative position movement Home search									
Input/Output	IJP OUT OTP	Jump input condition ON/OFF of output port ON pulse of output port									
Program control	JMP REP RPE END TIM NOP	Jump Start repetition End repetition End program Timer									
Teaching Unit (PMC-STU-232, It is optional.)	<ul style="list-style-type: none"> • Record of operation mode, parameter and program • Drive operation(Scan operation, program execution, home search, etc) 										
Control Interface	<ul style="list-style-type: none"> • Parallel P I/F • RS-232C • USB However, PMC-1HS-232 does not have USB I/F 	<ul style="list-style-type: none"> • Parallel P I/F • RS-232C • USB However, PMC-2HS-232 does not have USB I/F 									
General output	1 end point	2 end point (1 end point per axis)									
Input power	24VDC										
Consumption current	Max. 0.25A when I/O signal is open										
Range of operating temperature	0 ~ 45°C (at non-dew status)										
External size	Height 90 mm×Width 36 mm×Depth 64 mm										
Weight	96g	102g									
Accessories	CN1:MC 1, 5/2-ST-3.5(PHOENIX) Identified 1 CN3:20P MIL Standard, 2.54mm Connector 1 CN4:16P MIL Standard, 2.54mm Connector 1, RS-232C Communication cable(1.5m) 1, USB Communication cable(1.5m) 1 (Only for PMC-1HS-USB)	CN1:MC 1, 5/2-ST-3.5(PHOENIX) Identified 1 CN3:20P MIL Standard, 2.54mm Connector 1 CN4, 5:16P MIL Standard, 2.54mm Connector 1, RS-232C Communication cable(1.5m) 1, USB Communication cable(1.5m) 1									

7.2 Connector Types and I/O Signal Connection

Connector positions and pin numbers of PMC-2HS-USB is shown in the figure below.

Note that you connect wires following pin number correctly. If the power connector(CN1) is connected in reverse or any current/voltage in excess of the rated current/voltage are entered to each signal, internal circuit may be broken.

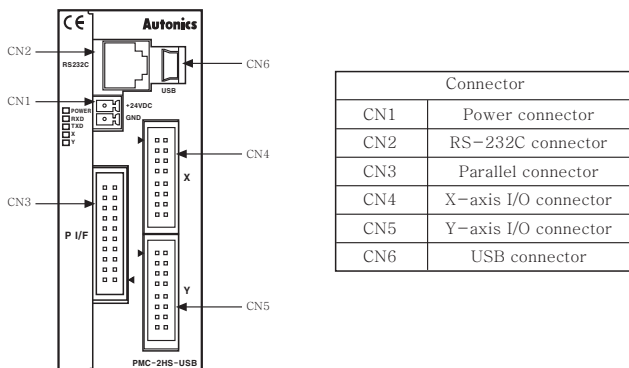

PMC-1HS-232C does not have CN5 and CN6, and PMC-1HS-USB does not have CN5.

7.2.1 CN1 Power Connector

Connect the power of 24VDC to it. Connect the power fitting to the polarity.

Pin No.	Signal Name
1	+24V
2	GEX (0V)

7.2.2 CN2 RS-232C Serial I/F Connector

It is the RS-232C serial communication connector. It connects to a communication port in a PC or a teaching unit by means of the serial communication cable for the program edit mode or the manual operation mode by the PC or the teaching unit (PMC-2TU-232).

Pin No.	Signal name	I/O	Description
1	TXD	Output	Receiving data
2	RXD	Input	Transmitting data
3	GND		Ground
4			No-connection
5			No-connection
6			No-connection

Reference) The internal wiring diagram of RS-232C communication cable is as shown below.

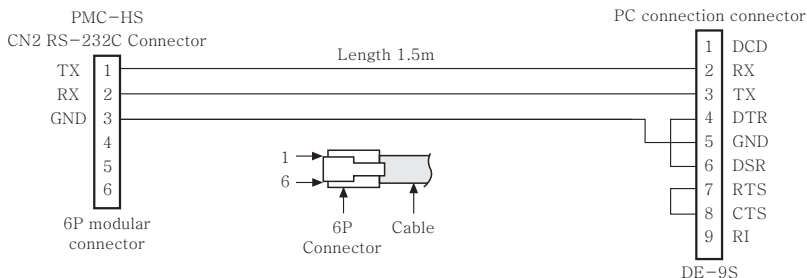

7.2.3 CN3 Parallel P I/F Connector

It is used to drive a program registered in PMC-1HS/PMC-2HS or index data with connection a parallel interface (P I/F) to a sequencer or mechanical junction. For I/O signal, the ON/OFF state of input signal means that the signal is connected to GEX or opened via a mechanical junction or an open collector. In addition, 'The output is in the ON state' means that an open collector output transistor becomes high.

Pin #	Signal name	I/O	Description
1	RESET	Input	Reset
2	HOME	Input	Home search start command
3	STORE	Input	Drive start command
4	X/SCANY +	Input	X-axis specification/Scan Y+
5	Y/SCANY -	Input	Y-axis specification/Scan Y-
6	REGSL0/RUN+/SCANX+	Input	Register specification 0/Run+/Scan X+
7	REGSL1/RUN-/SCANX-	Input	Register specification 1/Run-/Scan X-
8	REGSL2/SPD0	Input	Register specification 2/Drive speed specification 0
9	REGSL3/SPD1	Input	Register specification 3/Drive speed specification 1
10	REGSL4/SPD2	Input	Register specification 4/Scan specification
11	REGSL5/STOP	Input	Register specification 5/Drive stop
12	MODE0	Input	Operation mode specification 0
13	MODE1	Input	Operation mode specification 1
14	XDRIVE/END	Output	X-axis drive/Drive end pulse
15	YDRIVE/END	Output	Y-axis drive/Drive end pulse
16	XERROR	Output	X-axis error
17	YERROR	Output	Y-axis error
18	GEX		Ground
19	GEX		Ground
20	VEX		Power output (Less than 24VDC, 100mA)

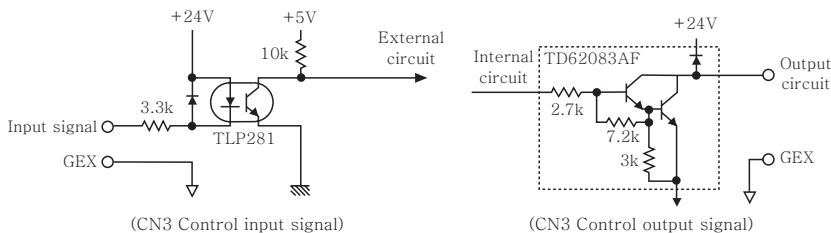

●Description 1 : RESET Pin 1 (Input, reset)

In ON state, all internal operations are reset. Please, make the ON state more 80 msec.
It can be used as the emergency stop signal.

●Description 2 : HOME Pin 2 Input (Home search start command)

When the X/Y axis specification signal is in the ON state, X/Y axis starts the home search operation simultaneously. When only the selected axis is in the ON state, only the axis starts the home search operation. If the nDRIVE/END signal is used as the drive end pulse, make the Home signal in the ON state of more than 80 msec.

【Caution】 Do not make the signal in the ON state during the scan drive.

●Description 3 : STROBE Pin3(Input drive start command)

The STROBE Pin3 is the start command signal in Index mode and Program mode.

If you make this signal in ON state after specifying a register number and X/Y axis, the drive starts. Make the STROBE signal in the ON state of more than 80 msec or check if the nDRIVE/END signal is in the ON state. After then, return the signal in the OFF state.

However, if the nDrive/END signal is used as the drive end pulse, make the STROBE signal in the ON state of 80 msec.

●Description 4 : X/SCANY+ Pin4(Input, X-axis specification/Y+ in Scan drive mode)

Y/SCANY- Pin5(Input, Y-axis specification/Y- in Scan drive mode)

This signal specifies an axis in the Index mode and the Program mode. If the specified axis goes to the ON state, the relevant axis is selected. Before the STROBE signal is in the ON state, the axis specification signal must be in the ON state.

In the Scan drive 2 mode, if SCANY+ and SCANY- are changed to the ON state, the drive pulse comes out in the Y+ and Y- directions respectively.

●Description 5 : REGSL0/RUN+/SCANX+ Pin6(Input, Register specification0/RUN+/X+ in Scan drive mode)

REGSL1/RUN-/SCANX- Pin7(Input, Register specification1/RUN-/X- in Scan drive mode)

REGSL2/SPD0 Pin8(Input, Register specification2/Drive speed specification0)

REGSL3/SPD1 Pin9(Input, Register specification3/ Drive speed specification1)

REGSL4/SCAN Pin10(Input, Register specification4/Scan specification0)

REGSL5/STOP Pin11(Input, Register specification5/ Drive stop)

These signals specify REG numbers in the Index mode and the Program mode.

REGSL0 and REGSL5 are LSB and HSB respectively, and the signals specify REG numbers 0~63. RUN+ and RUN- are separately used in the Scan drive1 and Continuous mode respectively. In addition, when RUN- is in the ON state, the drive pulse comes out in the -direction. At this time, the drive speed is configured as SPD0 and SPD1.

< Drive speed specification >

Drive Speed	SPD1	SPD0
Drive Speed 1	OFF	OFF
Drive Speed 2	OFF	ON
Drive Speed 3	ON	OFF
Drive Speed 4	ON	ON

If SCANX+ and SCANX- are in the ON state in the Scan drive2 mode, the drive pulse comes out in the X+, Y- direction respectively. The STOP signal is the drive stop signal, if the signal enters to the ON state, the drive stops. The signal has different functions depending on the operational mode as listed in the table below.

In addition, the signal operates in the ON state of 80 msec to operate.

Operation mode	Operation of the Stop Signal in the ON state
Index drive	Stop the running drive of the ABS or the INC command(See Caution 1).
Scan Drive 1, 2	Disable
Continuous Drive	Stop the continuous drive.
Program Drive	Stop the program drive. Stop the drive, if a drive command is running(See Caution 1).
Home Search	Stop during the executing of home search.

【Caution】 Do not make the STOP signal in the ON state in Scan drive mode.
 This signal uses the function of the register specification(REGSL5).
 If the signal is in the ON state to specify registers when a drive is getting started,
 configure the STROBE signal as OFF and REGSL5/Stop signal as ON, after then
 the STROBE signal as ON again. The drive will be stopped.
 If the drive stops, return the signal to the OFF state. Refer to the figure below.

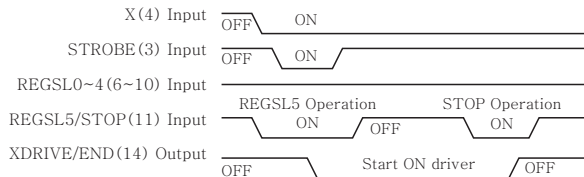

- Description 6 : MODE0 Pin12(Input, Operation mode specification 0)
 MODE1 Pin13(Input, Operation mode specification 1)
 These signals specify the operation mode in parallel P I/F.

MODE1(13)	MODE0(12)	Operation mode
OFF	OFF	Index dive
OFF	ON	Scan drive Scan drive 1 : SCAN(10) = OFF Scan drive 2 : SCAN(10) = ON
ON	OFF	Continuous drive
ON	ON	Program drive

- Description 7 : XDRIVE/END Pin14(Output, On X-axis drive/Drive end pulse)
 YDRIVE/END Pin15(Output, On Y-axis drive/Drive end pulse)
 These output signals are in the ON state when the drive pulse comes out.
 However, it is applied in different ways depending on the operation mode in parallel P I/F and the mode configured in main body.

<Operation of DRIVE/END(14, 15) output signal>

Operation Mode in Parallel P I/F	When the drive end pulse is disabled according to the mode configured in the main body.	When the drive end pulse is enabled according to the mode configured in the main body,
Home Search	The signal is ON in searching the Home and OFF after ending.	The signal is OFF in searching the Home and the drive end pulse comes out after ending.
Index Drive	The signal is ON in the drive pulse output and OFF after ending.	The drive end pulse comes out if the command that the end pulsed is enabled is completed.
Scan Drive	The signal is ON in searching the Home and OFF after ending.	The signal is OFF in driving and the drive end pulse comes out after ending.
Continuous Drive	The signal is ON in searching the Home and OFF after ending.	The signal is OFF in driving and the drive end pulse comes out after ending.
Program Drive	The signal is ON in searching the Home and OFF after ending.	The drive end pulse comes out if the command that the end pulse is enabled is completed.

- Description 8 : XERROR Pin16(Output, X-axis error output)
 YERROR Pin17(Output, Y-axis error output)
 For the control on each axis, the signal is ON if an error is occurred.

7.2.4 CN4, CN5 I/O Connector

CN4 and CN5 are the I/O signals for X-axis and Y-axis respectively. The pin arrangement of CN4 and CN5 are equal. PMC-1HS does not have CN5.

'n' in the table means X for CN4 and Y for CN5.

Pin #	Signal name	I/O	Description
1	nP+P	Output	Drive pulse in the + direction
2	nP+N	Output	Drive pulse in the + direction
3	nP-P	Output	Drive pulse in the - direction
4	nP-N	Output	Drive pulse in the - direction
5	nOUT0	Output	General output0/DCC
6	nINPOS	Input	Servo inposition
7	nALARM	Input	Servo alarm
8	GEX		Ground
9	nSTOP2	Input	Encoder Z-phase
10	nSTOP1	Input	Home
11	nSTOPO	Input	Near Home
12	nLMT+	Input	LMT+
13	nLMT-	Input	LMT-
14	EMG	Input	Emergency stop
15	GEX		Ground
16	VEV		Output power(+24V) for sensor

- Description 1 : nP+P Pin1 (Output, + direction drive pulse) (n=X, Y)

nP+N Pin2 (Output, + direction drive pulse)

nP-P Pin3 (Output, - direction drive pulse)

nP-N Pin4 (Output, - direction drive pulse)

The drive pulse output signal comes out from the line drive(AM26C31C) of the differential output. nP+N and nP-N are inverted outputs of nP+P and nP-P, respectively.

When reset, nP+P, nP-P become Low and nP+N, nP-N become High.

An example for the connection with a motor driver is as shown below:



- Description 2 : nOUT0 Pin5 (Common output0/DCC output (n=X, Y))

This signal is a common output signal to control ON/OFF state by program operation. OUT command (ON/OFF of output port) and OTP command (ON pulse from output port) is used for this signal. If DCC operation is enabled by configuring the home search mode, the pulse output signal selected from the selection of DCC pulse width comes out as nOUR0 after the home search step3 (Z phase search) is completed. The level is selected as DCC level.

- Description 3 : nINPOS Pin6 (Input, Servo inposition (n=X, Y))

This is an input signal to connect the inposition output of a servo motor drive. To use the inposition signal, enable the inposition in the operation mode and configure its active level. For more information of its operation, refer to the servo inposition enable and the active level of "Chapter 3.2 Mode configuration."

- Description 4 : nALARM Pin7(Input, Servo alarm (n=X, Y))
 The signal is an input to connect the alarm (Alarm) output of a servo driver.
 To use this signal, enable the servo alarm in the operation mode and configure its active level. For more information of its operation, refer to the servo inposition enable and the active level of "Chapter 3.2 Mode configuration."

- Description 5 : nSTOP2 Pin9(Input, Encoder Z-phase (n=X, Y))
 nSTOP1 Pin10(Input, Home)
 nSTPO0 Pin11(Input, Near Home)
 This is the input signal for the home search. For more information of the home search operation, refer to "3.2 Configuration of Home search Mode"

- Description 6 : nLMT+ Pin12(Input, LMT+ (n=X, Y))
 nLMT- Pin13(Input, LMT-)
 nLMT+ input signal is the Overrun limit signal with the + direction.
 If the nLMT+ input signal is active while the drive pulse comes out in the + direction, the drive decelerates to stop or stops immediately. Meanwhile, nLMT- input signal is Limit signal with the - direction. If the nLMT- input signal is active while the drive pulse comes out in the - direction, the drive decelerates to stop or stops immediately. Once the drive is stopped, the drive in a CW direction is available regardless of the active status of the nLMT- input signal. Deceleration to stop/Instant stop of Limit stop and its active level are configurable.
 An example to connect of Limit and Home signal is as shown below.

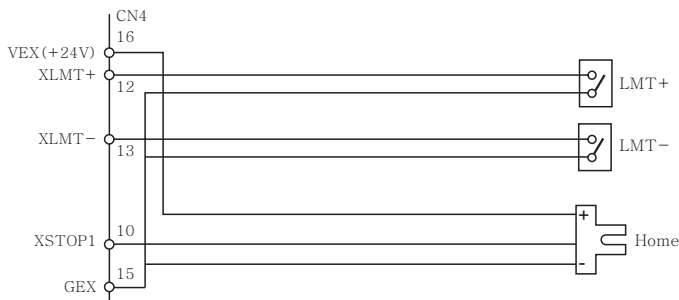

- Description 7 : EMG Pin14(Input, Emergency stop)
 If the EMG input signal is in the ON state, you can immediately stop all driving axes.
 The signal can not select the active level. The signal is typically in the OFF state (Open). However, if the signal is changed into the ON state (GEX connection), axes are immediately stopped.

- Description 8 : VEX Pin16(Power output for sensor)
 This is the output power (+24V) to supply the power to the limit, home sensor.
 Configure the power at less than 100mA. The VEX power is transferred to CN3, CN4 and CN5. Configure the power at lees than 300mA.

PIC

Relative position movement drive. It drives the specified axis to a relative position.

Format

Command△ [Relative position coordinate on X-axis] [Relative position coordinate on Y-axis] [CR]

PIC△ ○○○○○○○○○○.○○○○○○○○○○ [CR]

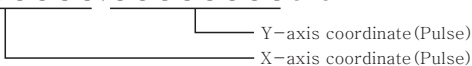

[Example] • To move only Y-axis to a relative position -1500 pulse for 2-axis

PIC△, -1500 [CR]

In case of CCW rotation, mark - sign.

• To move to a relation position -3000 pulse for a-axis

PIC△-3000 [CR]

Response : No-response

CLL

It clears an active position counter. The CLL clears the active position counter of the specified axis.

Format

Command△ [Axis specification] [CR]

CLL△

X	[CR]
Y	

Put the axis specification "X" in case of PMC-1HS.

[Example] • To clear X/Y axis for 2-axis

CLL△XY[CR]

• To clear for 1-axis

CLL△X [CR]

Response : No-response

CLR

It clears an actual position counter. The CLR clears the actual position counter.

Format

Command△ [Axis specification] [CR]

CLR△

X	[CR]
Y	

Put the axis specification "X" in case of PMC-1HS.

[Example] • To clear X and Y axis for 2-axis

CLR△XY[CR]

• To clear for 1-axis

CLR△X [CR]

Response : No-response

SPD

It changes the drive speed and read the current speed.

It changes the speed of the current drive and reads the speed value of each axis operation.

• To configure the speed

Format

Command△ [Speed indication of X-axis] [Speed indication of Y-axis] [CR]

PIC△ ○○○○○○○○○○.○○○○○○○○○○ [CR]

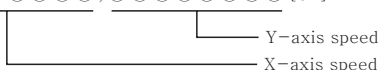

STO

It decelerates to stop the drive of the specified axis.

However, when the drive speed is lower than the start speed, the drive stops immediately.

Format

Command△ [Axis specification] [CR]

STO△ $\begin{array}{|c|} \hline X \\ \hline Y \\ \hline \end{array}$ [CR]

Setting an axis operates with arrangement.

Put the axis specification "X" in PMC-1HS.

[Example] • To decelerate for stop of X and Y axes in 2-axis

STO△XY [CR]

• To decelerate for stop of 1-axis

STO△X [CR]

Response : No-response

VER

It displays the version information of PMC-1HS/PMC-2HS.

Format

Command[CR]

VER[CR]

Response : POS△XXXXXXXX - XXXXXXXX - X - X [LF] [CR]

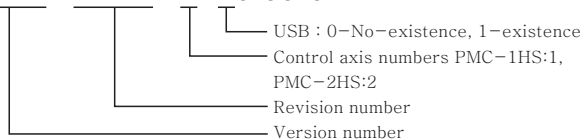

IDC

It returns the current program number [0~63] when PMC-1HS/PMC-2HS operates the program.

Format

Command△ [Axis specification] [CR]

IDC△ $\begin{array}{|c|} \hline X \\ \hline Y \\ \hline \end{array}$ [CR]

Put the axis specification "X" in 1-axis (PMC-1HS).

Response : IDC $\begin{array}{|c|} \hline X \\ \hline Y \\ \hline \end{array}$ ○○ [CR]

Program number

SSM

It selects the speed(1~4).

Format

Command△ [Axis specification] [Speed selection] [CR]

SSM△ $\begin{array}{|c|} \hline X \\ \hline Y \\ \hline \end{array}$ ○ [CR]

Put the axis specification "X" in PMC-1HS.

Response : Response

INR

It returns input signal and connector signal(CN3) in hexadecimal.

Format

Command Δ [Axis specification] [CR]

INR Δ $\begin{matrix} |X| \\ |Y| \end{matrix}$ [CR]

Put the axis specification "X" for 1-axis (PMC-1HS).

Response : INR Δ $\begin{matrix} |X| \\ |Y| \end{matrix}$ $\circ\circ\circ\circ, \Delta \circ\circ\circ\circ$ [CR]

Hexadecimal from the bit composition of the connector (CN3) signal

Hexadecimal from the bit composing of the X and Y I/O signal

Hexadecimal from the bit composition of the X and Y I/O signal

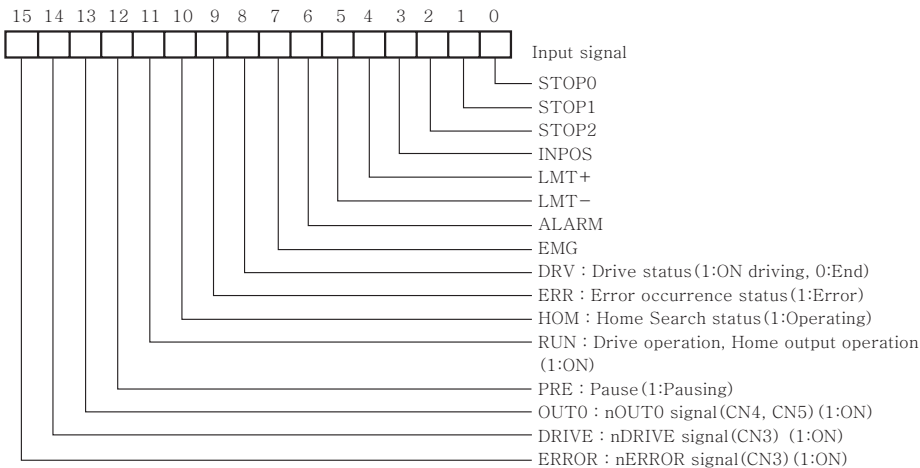

Bit composition of connector(CN3) signal

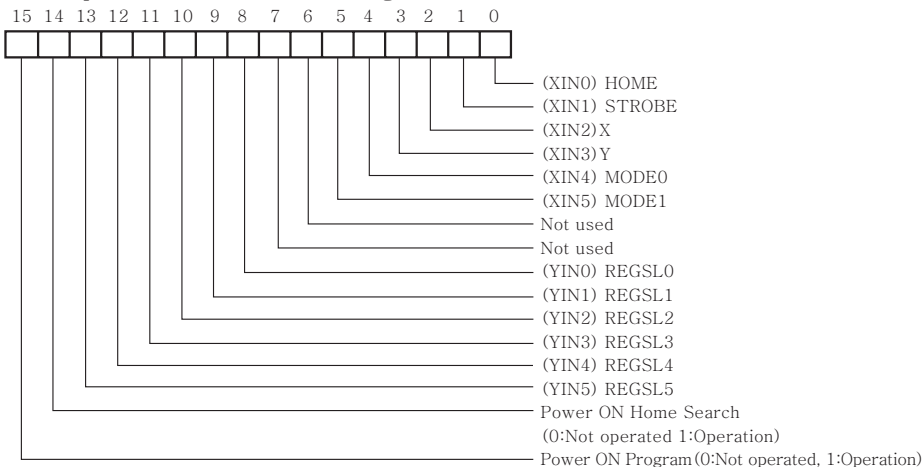

OUT

Control the output signal. The OUT controls the output signal by means of bit pattern, configures as hexadecimal.

Format

Command△ [Data] [CR]

OUT△○○○○ [CR]

Bit composition

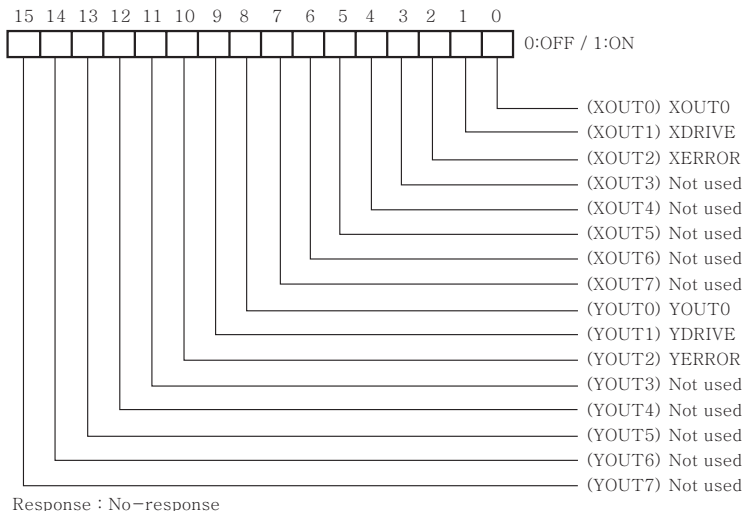

RST

It resets the motion control IC.

The RST only resets the motion control IC.

Format

Command[CR]

RST[CR]

Response : No-response

SCI

It reads or modifies the condition of a communication port.

If the port condition is modified, reset of main body or power is required.

(1)For reading

Format

Command [CR]

SCI [CR]

(2)For writing

Format

Command△ [Baud Rate], [Data Bit] [Stop Bit] [Parity] [CR]

SCI△19200, 8, 1, 0 [CR]

Writing data types

Baud rate	:	9 6 0 0 [9600bps]
		1 9 2 0 0 [19200bps]
		3 8 4 0 0 [38400bps]
		5 7 6 0 0 [57600bps]
		1 1 5 2 0 0 [115200bps]
Data bit	:	8 [8bit]
		7 [7bit]
Stop bit	:	1 [1bit]
		2 [2bit]
Parity	:	0 [No-parity]
		1 [Odd parity]
		2 [Even parity]

Response : (1)In reading

The data for reading has the same format as the data for writing.

(2)In writing

The data for writing is applied.

Note)When configuring baud rate as 115200 bps, it may cause connection trouble of communication.

OGE

It ends Home Search by force.

Format

Command△ [Axis specification] [CR]

OGE△ $\begin{array}{|c|} \hline X \\ \hline Y \\ \hline \end{array}$ [CR]

Put the axis specification "X" in 1-axis(PMC-1HS).

[Example] • To end Home Search of X and Y axis by force, for 2-axis.

OGE△XY [CR]

• To end Home Search, for 1-axis.

OGE△X [CR]

Response : No-response

PSP

It stops a program or a drive step temporarily.

Format

Command△ [Axis specification] [CR]

PSP△ $\begin{array}{|c|} \hline X \\ \hline Y \\ \hline \end{array}$ [CR]

Put the axis specification "X" in 1-axis(PMC-1HS).

[Example] • To pause the program or drive step on X/Y axis for 2-axis.

PSP△XY [CR]

• To pause the program or drive step for 1-axis.

PSP△X [CR]

Response : No-response

EDP

It ends a program by force

Format

Command△ [Axis specification] [CR]

EDP△ $\begin{vmatrix} X \\ Y \end{vmatrix}$ [CR]

Put the axis specification "X" in 1-axis (PMC-1HS).

[Example] • To end a program on X/Y axis for 2-axis by force.

EDP△XY [CR]

• To end a program for 1-axis by force.

EDP△X [CR]

Response : No-response

PRS

It restarts a program

Format

Command△ [Axis specification] [CR]

PRS△ $\begin{vmatrix} X \\ Y \end{vmatrix}$ [CR]

Put the axis specification "X" in 1-axis (PMC-1HS).

[Example] • To restart a program on X/Y axis.

PRS△XY [CR]

• To restart a program for 1-axis.

PRS△X [CR]

Response : No-response

PST

It runs program step by step.

Format

Command△ [Axis specification] [Register specification] [CR]

PST△ $\begin{vmatrix} X \\ Y \end{vmatrix}$ [CR]

Put the axis specification "X" in 1-axis (PMC-1HS).

[Example] • To run a X and Y-axis program step by step for 2-axis

PST△XY 00 [CR]

• To run a program step by step

PST△X 00 [CR]

Response : No-response

ERD

It reads the error status of the main body.

Format

Command△ [Axis specification] [CR]

ERD△ $\begin{vmatrix} X \\ Y \end{vmatrix}$ [CR]

Put the axis specification "X" in 1-axis (PMC-1HS).

[Response]

ERD△ $\begin{vmatrix} X \\ Y \end{vmatrix}$ $\begin{array}{cccc} \bigcirc & \bigcirc & \bigcirc & \bigcirc \\ \hline & & & \end{array}$ [CR]

Error code of the main body

Bit composition of the Error status

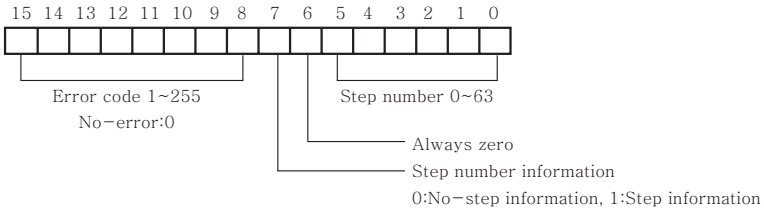

Error code(BIT15-08)=0 means the error free status.

BIT15 HOME ERROR

BIT14 PROGRAM ERROR (PROGRAM OVERRUN ERROR STEP>=Include 64)

BIT13 EMG ERROR

BIT12 ALARM ERROR

BIT11 HARDWARE LIMIT - ERROR

BIT10 HARDWARE LIMIT + ERROR

BIT09 SOFTWARE LIMIT - ERROR

BIT08 SOFTWARE LIMIT + ERROR

[Data] Reading and Writing of Parameter/Mode Values

 : Basic command

No	Item	Name	REG	Byte numbers (byte)	IXS	IXR	IHS	IHR
	position_data 0	Position0 Data	01/00	01/00	00	00	01/00	01/00
	position_data 63	Position63 data	7F/7E	7F/7E	3F	3F	7F/7E	7F/7E
	reserved 0	Reservation						
	program_mode	Program mode	E3	E3	71-H	71-H	E3	E3
	Operatint_Mode	Operation mode	E4	E4	72-L	72-L	E4	E4
	Input_filter	Input signal filter	E5	E5	72-H	72-H	E5	E5
	Speed_Multiplier	Speed multiplier	E6	E6	73-L	73-L	E6	E6
	Acceleration_Acceleration_Rate	Acceleration- acceleration rate	E7	E7	73-H	73-H	E7	E7
	Acceleration_Rate	Acceleration rate	E8	E8	74-L	74-L	E8	E8
	Deceleration_Rate	Deceleration rate	E9	E9	74-H	74-H	E9	E9
	Start_Speed	Start speed	EA	EA	75-L	75-L	EA	EA
	Drive_Speed1	Drive speed1	EB	EB	75-H	75-H	EB	EB
	Drive_Speed2	Drive speed2	EC	EC	76-L	76-L	EC	EC
	Drive_Speed3	Drive speed3	ED	ED	76-H	76-H	ED	ED
	Drive_Speed4	Drive speed4	EE	EE	77-L	77-L	EE	EE
	Home_Search_High_Speed	Home search high speed	EF	EF	77-H	77-H	EF	EF
	Home_Search_Low_Speed	Home search low speed	F0	F0	78-L	78-L	F0	F0
	Home_Search_Mode	Home search mode	F1	F1	78-H	78-H	F1	F1
	Home_Search_Offset	Home search offset	F3/F2	F3/F2	79	79	F3/F2	F3/F2
	Soft_Ware_Limit+	Soft limit+	F5/F4	F5/F4	7A	7A	F5/F4	F5/F4
	Soft_Ware_Limit-	Soft limit-	F7/F6	F7/F6	7B	7B	F7/F6	F7/F6
	Post_Timer1	Timer1	F8	F8	7C-L	7C-L	F8	F8
	Post_Timer2	Timer2	F9	F9	7C-H	7C-H	F9	F9
	Post_Timer3	Timer3	FA	FA	7D-L	7D-L	FA	FA
	End_Pulse_Width	End pulse width	FB	FB	7D-H	7D-H	FB	FB
	Pulse_Scale_Numerator	Pulse scale numerator	FC	FC	7E-L	7E-L	FC	FC
	Pulse_Scale_Denominator	Pulse scale denominator	FE	FE	7F-L	7F-L	FE	FE

※ The default value of position data X00-63 and Y00-Y63 is "FFFFFFF."

Autonics

www.autonics.com

■ Satisfiable Partner For Factory Automation

■ HEADQUARTERS :

41-5, Yongdang-ri, Uingsang-eup, Yangsan-si, Gyeongnam, 626-847, Korea

■ OVERSEAS SALES :

Bldg. 402 3rd Fl., Bucheon Techno Park, 193, Yakdae-dong, Wonmi-gu, Bucheon-si, Gyeonggi-do, 420-734, Korea

TEL:82-32-610-2730 / FAX:82-32-329-0728

■ E-mail : sales@autonics.com

■ MAIN PRODUCTS

■ COUNTER ■ TIMER ■ TEMPERATURE CONTROLLER ■ PANEL METER ■ TACHO/LINE SPEED/PULSE METER
■ DISPLAY UNIT ■ PROXIMITY SENSOR ■ PHOTOELECTRIC SENSOR ■ FIBER OPTIC SENSOR
■ PRESSURE SENSOR ■ ROTARY ENCODER ■ SENSOR CONTROLLER ■ POWER CONTROLLER
■ STEPPING MOTOR & DRIVER & CONTROLLER ■ LASER MARKING SYSTEM(CO₂, Nd:YAG)